

# Table of Contents

Table of Contents	1
Cut2D Desktop Help	15
Disclaimer	16
Cut2D Desktop Reference Manual	17
Introduction	18
User Guides, tutorial and training	18
License Dialog	18
Online Method	18
Manual Method	20
View Controls	20
2D View Controls	21
3D View Controls	21
The View Toolbar	21
Snapping Toggle Options	22
View Controls	22
Toolpath Drawing Toggle	22
3D Drawing	22
Tile 2D & 3D View Windows	22
Two-Sided Machining	22
The Drawing Tab	23
File Operations	24
New, Open and Save	24
File Types	24
SketchUp Files	24
Layout of Imported Data	25
Three Views - Front, Top, Side	25
Exploded Flat Layout	26
Part Orientation	26
Auto Orientate	27
Orientate by material	27
Gap between parts	27
Create Circles / Arcs	27
Data to Import	27
Component / Group Handling	28
Group imported parts	29
Keep components starting with two underscores (__) together	29
Replace outer boundary (for flat jobs only!)	29
PDF Export	30
Vector(s)	30
Sheets	30
Layers	30
Options	30
Cut, Copy and Paste	30
Job Setup	31
Job Setup - Single Sided	31
Job Type	31
Job Size	31
Z Zero Position	31
XY Datum Position	31
Use Offset	32
Design Scaling	32
Job Setup - Double Sided	32
Job Type	32
Job Size	32
Z Zero Position	32
Zero off same side	32
XY Datum Position	32
Use Offset	32
Flip Direction Between Sides	33
Design Scaling	33
The Create Vectors Tool Group	34
Drawing Shapes	34

Creating Text	34
Trace Bitmap	34
Dimensions	34
Draw Circle	34
Interactive	34
Cursor	34
Quick Keys	35
Exact Size	35
Edit	35
Close the form	35
Draw Ellipse	35
Interactive - Cursor	35
Quick Keys	36
Default	36
Example	36
Specifying Further Properties	36
Examples	36
Exact Size	36
Edit	36
Close the form	36
Draw Rectangle	37
Interactive - Cursor	37
Quick Keys	37
Default	37
Example	37
Specifying Further Properties	37
Examples	38
Exact Size	38
Corner Type	38
Edit	38
Close the form	39
Draw Polygon	39
Interactive - Cursor	39
Quick Keys	39
Default	39
Example	40
Specifying Further Properties	40
Examples	40
Exact Size	40
Edit	40
Close the form	40
Draw Star	41
Interactive - cursor	41
Quick Keys	41
Default	41
Example	41
Specifying Further Properties	41
Examples	42
Exact Size	42
Edit	42
Close the form	42
Draw Polyline	42
Interactive - cursor	42
Creating Tangent Lines	43
From A Point To An Arc	43
From An Arc To A Point	43
From An Arc To Another Arc	43
Extending Contours	43
Quick Keys	43
Default	43
Example	44
Specifying Further Properties	44
Examples	44
Next Point	44
Create Arc	44

Through 3 Points	44
Center, Start and End	44
Exact Size	45
Editing An Existing Arc	45
Draw Curve	45
Extending Contours	45
Create Vector Texture	46
Angle	46
Line Spacing	46
Wave Parameters	46
Wavelength	47
Amplitude	47
Noise	48
Vector Layer	50
Applications	50
Create Text	51
Vertical Fonts	52
Engraving Fonts	52
Options	52
Text Alignment	52
Anchor	52
Edit Text	52
Auto Layout Text	53
Entering Text	53
Vertical Fonts	53
Engraving Fonts	53
Options	53
Text Alignment	54
Bounding Box Dimensions	54
Margin Size	54
Vertical Stretch	54
Horizontal Stretch	54
Edit Text	55
Text Selection	55
Interactive Letter kerning and Line Spacing	55
Letter Kerning	55
Line Spacing	56
Text Arcing	56
Convert text to Curves	57
Text on Curve	58
Text Size	58
Maintain text Size	58
Scale text to fill curve	58
Text Spacing	58
Text Position	58
Offset Distance	59
Text Alignment	59
Trace Bitmap	60
Tracing a Selected Area of the Bitmap	60
Working with Color Images	60
Working with Black and White Images	60
Fitting-Options	60
Corner Fit	60
Loose	61
Tight	61
Noise Filter	61
Bitmap Fading	61
Preview	61
Apply	61
Close	61
Dimensions	62
Length Dimension	62
Vertical / Horizontal Dimension	62
Angle Dimension	63
Arc Dimension	63

Font Selection and Settings	64
Use Custom Text	64
Place Dimensions on Layer	64
Transform Objects	65
Quick Keys	65
Inputting a Value	65
Move Selection	65
Anchor	65
Type of Move	65
Absolute	65
Relative	65
Move Interactive	65
Quick Keys	66
Smart Snapping	66
Set Size	66
Anchor	66
Link XY	66
Auto Scale Z	66
Size Interactive	66
Interactive Handles	67
Quick Keys	67
Rotate	67
Pivot Point	67
Use Coordinates	67
Angle	67
Rotate Interactive	68
Quick Keys	68
Mirror	68
Shortcuts	68
Distort Tool	69
Baking Distortion into an Object	69
Bounding Box	69
Along a Single Curve	69
Between Two Curves	69
Alignment Tools	70
Align to Material	70
Center in Material	70
Center in Material X only	70
Center in Material Y only	70
Align to Selection	70
Align Center	70
Align horizontal center	70
Align vertical center	71
Align Left/Right	71
Align Top/Bottom	71
Align Outside Left/Right	71
Align Outside Top/Bottom	71
Space Selection	71
Show common tools on drawing tab	71
The Edit Objects Tool Group	72
Object Selection Tools	72
Editing Modes	72
Vector Selection Mode	72
Vector selection methods	72
Deselecting Vectors	73
Node Editing Mode	73
Interactive Selection Mode	73
Grouping and Ungrouping	74
Group selected Objects	74
Ungroup Selection	74
Ungroup to the group's layer	74
Measure Tool	75
Measure Between 2 Points	75
Distance	75
Angle	75

X Distance	75
Y Distance	75
First Point	75
Cursor Position	75
Span / Contour Properties	75
Type	75
Length	75
Start Point and End Point	75
Vector	75
Area	75
Perimeter	76
Num. Spans	76
Object Merge tools	76
Weld Vectors	76
Subtract Vectors	76
Keep Overlap of Vectors	76
Trim Objects	76
Interactive Vector Trim	77
Vector Validator	78
Marks	78
Create Fillets	79
Fillet / Tool Radius	80
Fillet Type	80
Normal fillet	80
Dog-Bone Fillet	80
T-Bone Fillet	80
Removing Fillets	81
Extend Vectors	82
Fit Curves to Vectors	83
Fitting Type...	83
Circular Arcs	83
Bezier Curves	83
Straight Lines	83
Tolerance:	83
Keep Sharp Corners	84
Replace selected vectors	84
Vector Boundary	84
Offset Boundary	84
Rubber Band Boundary	84
Edit Picture	85
Contrast	85
Brightness	85
Gamma	85
Invert	85
Grayscale	85
Add Border	85
Crop Bitmap	85
Joining and Closing Tools	86
Join Open Vectors	86
Join/Close vectors with a straight line	86
Join/Close vectors with a smooth curve	86
Join/Close by Moving End Points	87
The Offset and Layout Tool Group	88
Offset Vectors	88
Options	88
Create sharp offset corners	88
Offsetting Open Vectors	88
Notes	88
Array Copy	89
Selected Objects Size	89
Rows and Columns	89
Spacing...	89
Symmetry...	89
Row/Column displacement...	90
Group Copies	91

Circular Copy	91
Rotation Center	91
Rotate Copies	91
Angle	92
Total Angle	92
Step Angle	92
Copying Multiple Vectors	92
Copy Along Vectors	92
Copy Object	92
Copy Circles	93
Distance between copies	93
Number of copies	93
Align Objects to curve	93
Create Copies on new layer	93
Reverse Direction	93
Toolpath Operations	94
Toolpaths	95
Prepare vectors for machining	95
Set up the Material	95
Create the Toolpaths	95
Preview the Toolpaths	95
Save the Toolpaths for the CNC machine	95
Additional Toolpath Tab Features	95
Switch to Drawing Tab	95
Toolpath Summary Area	95
Material Setup	96
Flat Material Setup	96
Thickness	96
XY Datum	96
Show detailed summary on toolpath tab	96
Side Z-Zero	96
Rapid Z Gaps above Material	96
Clearance (Z1)	96
Plunge (Z2)	96
Home / Start Position	97
The Toolpath List	98
Resizing the Toolpath List	98
Basic Toolpaths	99
Profile Toolpath	99
Cutting Depths	99
Start Depth (D)	99
Cut Depth (C)	99
Tool	99
Pass Depth Control for Profiling	99
Specify Pass Depths	100
Pass Depth List Utilities	100
Machine Vectors...	100
Direction	100
Allowance offset	100
Last Pass Allowance	101
Use vector start point	101
Tabs (Bridges)	101
Add tabs to toolpath	101
Create 3D Tabs	102
Edit Tabs	102
Add Tabs	102
Constant Number	102
Constant Distance between tabs	102
First tab at machining start point	103
Dynamically positioning tabs in the 2D View	103
Profile Options	103
Ramp	103
Smooth	103
Zig Zag	103
Spiral	104

Leads	104
Straight Line Lead	104
Circular Lead	104
Order	104
Vector Selection Order	104
Left to Right	104
Bottom to Top	104
Grid	104
Shortest Path	104
Start At	105
Keep Current Start Points	105
Optimize Start Points	105
Closest on Bounding Box	105
Corners	105
Sharp External Corners	105
Sharp Internal Corners	106
Allowance for Cut out tool	106
Additional notes on Profile Machining	106
Machining Open Vectors	106
Safe Z	107
Home Position	107
Vector Selection	107
Name	107
Pocketing Toolpath	107
Cutting Depths	107
Start Depth (D)	107
Cut Depth (C)	107
Tool	107
Specify Pass Depths	107
Pass Depth List Utilities	108
Use Larger Area Clearance Tool	108
Clear Pocket	108
Offset	108
Raster	108
Raster Angle	109
Profile Pass	109
Pocket Allowance	109
Ramp Plunge Moves	109
Use Vector Selection Order	109
Safe Z	110
Home Position	110
Vector Selection	110
Name	110
Drilling Toolpath	110
Cutting Depths	110
Start Depth (D)	110
Cut Depth (C)	110
Tool	110
Peck Drilling	110
Retract above cutting start	110
Retract above the height of the previous pass	110
Dwell at the bottom of each drill pass	111
Use Vector Selection Order	111
Safe Z	111
Home Position	111
Vector Selection	111
Name	111
Quick Engraving Toolpath	111
Tool	111
Depth / Pressure	111
Strategy	112
Outline	112
Fill	112
Use Nose Cone	113
Number of Passes	113

Output Options	113
Inlay Toolpath	113
How Inlays work	113
Male Inlay (Insert)	114
Straight	114
Stepped	114
Female Inlay (Pocket / Hole)	115
Pocket	115
Hole	115
Setting Inlay Allowances	115
Safe Z	116
Home Position	116
Vector Selection	116
Name	116
Laser Toolpaths	117
Laser Cut - Fill	117
Settings	117
Select	117
Power	117
Move Speed	117
No. Passes	117
Strategy	117
Allowance	118
Stepover	118
Hatch Angle	118
Cross Hatch	118
Toolpath Calculate	118
Safe Z	118
Home Position	118
Name	118
Calculate	118
Immediate Output	118
Post Processor	118
Add side to toolpath name	118
Output direct to machine	118
Laser Picture	119
Preparing the bitmap	119
Settings	119
Max Power	119
Min Power	119
Move Speed	119
Strategy Settings	120
Raster	120
Hatch	120
Selected	120
Dither Image	120
Line Spacing	120
Line Angle	120
Toolpath Calculate	120
Safe Z	120
Home Position	120
Name	120
Calculate	120
Immediate Output	121
Post Processor	121
Add side to toolpath name	121
Output direct to machine	121
Laser Module	121
The Laser Cut - Fill Toolpath	121
The Laser Picture Toolpath	121
Simulating Laser Toolpaths	121
Vector Selector	122
Selection	122
Geometry Filters	123
Layer Filter	123



Advanced Toolpath Templates	123
Toolpath Editing Tools	125
Edit Toolpath	125
Duplicate Toolpath	125
Delete Toolpath	125
Recalculate All Toolpaths	125
The Tool Database	126
Opening the tool database	126
Tool List	126
Tooltip of group hierarchy	126
Adding a New Tool	126
Copying a New Tool	127
Deleting a Tool	127
Creating a new tool group	127
Importing and Exporting tools	127
Tool Info	127
Name	127
Tool Type	127
Notes	128
Geometry	128
Diameter	128
Cutting Parameters	128
Pass Depth	128
Stepover	128
Final Pass Stepover	128
Clearance Pass Stepover	128
Feeds and Speed	128
Spindle Speed	128
Feed Rate	128
Plunge Rate	129
Maximum Burn Rate	129
Tool Number	129
Using Form Cutters	129
Adding your own custom form cutters	129
Preview Toolpaths	130
Material and Rendering Settings	130
Machined Area Color...	130
Material Color	130
Global Fill Color	130
Toolpath Color	130
Animate preview	130
Draw tool	130
Toolpath Preview Tools	130
Preview Toolpath	130
Preview Control Simulation	130
Preview All Sides	131
Preview All Toolpaths	131
Preview Visible Toolpaths	131
Delete Waste Material	131
Reset Preview	131
Save Preview Image	131
Adding Custom Materials	131
Multi-Colored Toolpath Preview	131
Solid Material Color	132
Machined Area Color	132
Use Material Color	132
Use Global Fill Color	132
Use Toolpath Color	132
Set All	133
Using the Multi Colored Toolpath Preview option with 3D toolpaths	133
Estimating Machining Times	134
Times	134
Rapid Rate	134
Scale Factor	134
Toolpath Tiling	135

The Toolpath Tiling Manager	135
Tiling Options	135
Individual Tiles	135
Feed-through in X or Feed-through in Y	135
Tile Previews	135
Simulating Tiled toolpaths	136
Saving toolpath tiles	136
Saving Toolpaths	137
Individual Toolpaths	137
Automatic Tool Changing Support	137
Error Messages	137
VTransfer	137
Getting Started	138
Initial Set-up	138
Controller Connection	138
Running a toolpath	138
Sending a toolpath directly to VTransfer from your Vectric software	138
Homing, Jogging and Origins	139
Start Homing Sequence	139
Z Touch Plate	139
Jogging	139
Setting and Resetting Origins	139
Running the Toolpath	139
Cut Now	140
Estimated Time Remaining	140
Dynamic Feedrate Override	140
Abort	140
Settings	140
Layers	141
Managing Layers	141
The Layer Control on the View Toolbar	141
The Layers Tab	141
List Item Command and Icons	141
Status Icon	141
Layer Color	142
Layer Content	142
Layer Name	142
Pop-up Menu	142
Additional Buttons and Icons	142
Show All / Hide All	142
Select All on a Layer	142
Layer Ordering Arrows	142
Add New Layer	143
Layer Name	143
Drawing Color	143
New Layer is Visible	143
New Layer is Active	143
Insert New Layer	143
Moving Layers	143
Program Options	143
Window Layout	144
3D View Settings	144
Toolpath Settings	144
General Settings	145
Rulers, Guide Lines and Snapping	145
Rulers↓	145
←Guidelines	145
Snapping Options	146
Display Text at Cursor	146
Snap to Guides	146
Snap Guides to Geometry	146
Snap to Grid	146
Snap Distances	146
Snap to Job Center and Corners	146
Fixed Nudge Distance	147

Snapping Radius	147
Geometry Snapping	147
Smart Snapping	147
Object Bounds	148
Vertical and Horizontal Lines	148
Tangents	148
Perpendicular to Tangents	149
Connecting Lines	149
Span Geometry	149
Angular Constraints	150
Job Edges & Centre	150
Toolbar Snapping Options	150
Document Variables	152
Naming Document Variables	152
Deleting Document Variables	152
Using Document Variables	152
Accessing Document Variables	153
Calculation Edit Boxes	154
Special Calculation Characters	154
Main Menu	155
File	155
Import	155
Export	155
Printing and Print Preview	156
Edit	156
Selection	156
Toolpaths Menu	157
Toolpath Drawing sub-menu	157
View	157
Help	158
Right Mouse Click menus	160
2D View Right Mouse Menu	160
Span Editing Menu	160
Node Editing Menu	160
Bitmap Properties Dialog	160
Component Grayscale Menu	160
Component Menu in the 3D View - Selected Components	161
Component Menu in the 3D View - Non Selected Components	161
Clipart Menu	161
Toolpath List Menu	161
Shortcut Keys	162
General Shortcut Keys	162
Tab Navigation	162
Double Sided Job Setup	162
Mirror	163
Alignment	163
Groups	163
Arrow keys	163
Node Editing	163
Quick Keys	164
Moving Objects M	164
Rotating Objects R	165
Scaling Objects T	165
Node Editing N	165
Polyline Tool	165
Draw Circle	165
Draw Ellipse	166
Draw Rectangle	166
Draw Polygon	166
Draw Star	166
What's New in Cut2D Desktop 9.5	168
New Drawing Tools	168
Smart Snapping	168
Quick Keys	168
Vector Validator	168

Enhanced & Extended Drawing Tools	168
Text-Editing (V9.5)	168
The Create Text Form (V9.5)	168
Arc Text (V9.5)	169
Picture Editing & Cropping(V9.5)	169
The Edit Picture Form (V9.5)	169
The Crop Bitmap Tool (V9.5)	169
Dimensioning	170
Shape Creation	170
Creating Tangent Lines	170
Extending A Polyline (V9.5)	170
Smoother Joining (V9.5)	170
Bitmap Background (V9.5)	171
Enhanced Toolpath Features	171
Setting Toolpath Start Point	171
Preserve Arcs across Toolpath Tiles	171
Helical Arc Support (V9.5)	171
General Improvements	171
Two-Sided Job Support	171
View Toolbar	171
Snapping Toggle Options	171
View Controls	172
Toolpath Drawing Toggle	172
Tile 2D & 3D View Windows	172
Export to PDF	172
Release Notes	173
9.519	173
Issues	173
9.518	173
Issues	173
9.517	173
Issues	173
9.516	173
Issues	173
9.515	173
Issues	173
9.514	173
Issues	173
9.513	174
Enhancement	174
Issues	174
9.512	174
Issues	174
9.511	174
Issues	174
9.510	174
Enhancement	174
Issues	174
9.509	174
Enhancement	175
Issues	175
9.508	175
9.507	175
9.500	175
Third Party Software Used by Cut2D Desktop	176
Cut2D Desktop User Guide	187
Introduction	188
User Guides, tutorial and training	188
General Workflow	189
Design	189
Toolpath	189
Output	189
Overview of the Interface	190
Managing the Interface	190
Accessing Auto-hidden tabs	190

Pinning and unpinning tools pages	190
Default layout for Design and Toolpaths	191
How to Get Started	192
Startup Tasks and Recently Opened Files	192
Video Tutorials	192
Online Resources	192
Frequently Asked Questions	193
Navigating this Document	193
General Questions	193
2D Design - Vectors & Images	193
SketchUp	194
Toolpaths	194
2D Design and Management	195
Vectors	195
Bitmaps	195
Vectors	195
Vector Import	195
Two-Sided Machining	196
Two-Sided Job Setup	196
Two-Sided Toolpath Management	197
Two-Sided Toolpath Previewing	197
Two-Sided Toolpath Saving	197
Glossary	198
2D View	198
3D View	198
Bitmap	198
Group	198
Ungroup	198
File	198
Short Cut Keys	198
Vector	198



# Cut2D Desktop Help

- Reference Manual
- User Guide

# Disclaimer

All CNC machines (routing, engraving, and milling) are potentially dangerous and because Vectric Ltd. has no control over how the software described in this manual might be used, Vectric Ltd. or any associated Resellers cannot accept responsibility for any loss or damage to the work piece, machine or any individual, howsoever caused by misusing the software. Extreme care should always be taken and the output from the software thoroughly checked before sending it to a CNC machine.

The information in this manual may be subject to change without any prior notice. The software described in this manual is supplied under the terms and conditions of the software license agreement and may only be used in accordance with the terms of this agreement.

**Vectric Ltd.**

**Web:** [www.vectric.com](http://www.vectric.com)

**Email:** [info@vectric.com](mailto:info@vectric.com)

**Phone:** +44 (0) 1527 850 323

**Fax:** +44 (0) 1527 850 323





# Cut2D Desktop Reference Manual

# Introduction

This manual is designed to provide a comprehensive description of all the functions, tools, menus and icons available within the Cut2D Desktop software package.

Access this document from Cut2D Desktop's **Help Menu ► Help Contents** or from the Cut2D Desktop folder in the program section of your Windows Start menu.

At the bottom of the page you will see an area with **View All Help**. This will download all the Help Documentation as a single web page which is useful for searching or if you need to create a paper copy of the documentation.

## User Guides, tutorial and training

Please note that this document is a Reference Manual. If you require more guidance, or are still learning how to use Cut2D Desktop, please ensure that you view the Getting Started Video Tutorials in the Cut2D Desktop Video Tutorial Browser when starting the software, or go to the User Manual section.

Cut2D Desktop also includes an extensive selection of video tutorials, which are accessible from the Tutorial Video Browser link when application first starts. These tutorials cover every aspect of Cut2D Desktop's functionality and range in complexity from a beginner's overview, to advanced features and principles. They are intended to be extremely accessible by level of experience or topic and use real-world examples throughout. Videos can be watched online, or installed locally.

We welcome any comments on this manual or the other training material, please email [support@vectric.com](mailto:support@vectric.com) with your feedback.

## License Dialog

The License Dialog is used to set the details you need to activate the software. This dialog can also be used to activate optional modules. The page that initially appears will give you the option to set your license details either automatically from your V&Co account or manually.

The 'Online Method' section below covers the process to follow if Online is selected.

The 'Manual Method' section below shows the process to follow if you wish to type in your license details manually or do not have an Internet connection available.

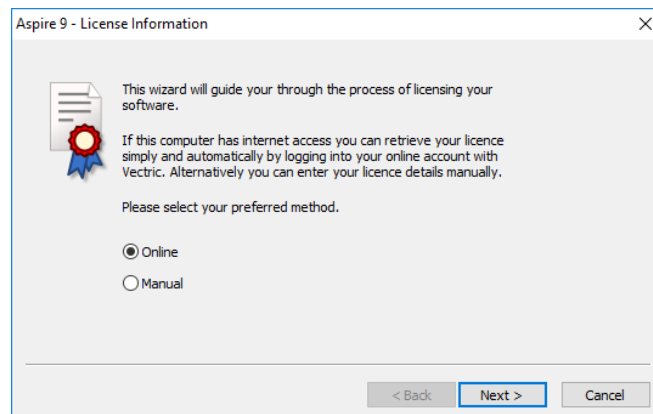

## Online Method

This method will allow you to retrieve your details automatically from your V&Co account. To use this select 'Online' and then click **Next >** on the form. The online section of the form will then be displayed.

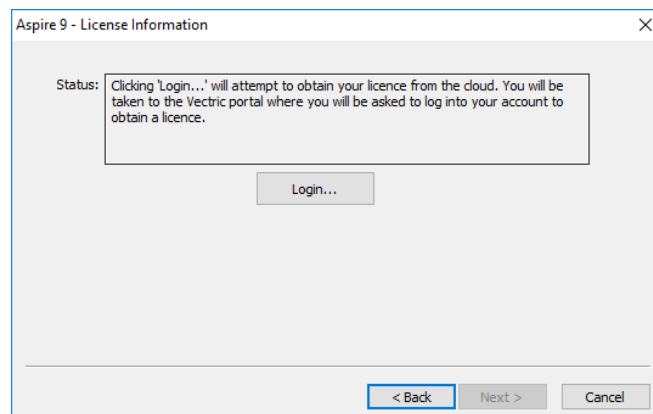

Pressing **Login...** on this dialog will launch a web browser which will take you to the V&Co login page if authentication is required.

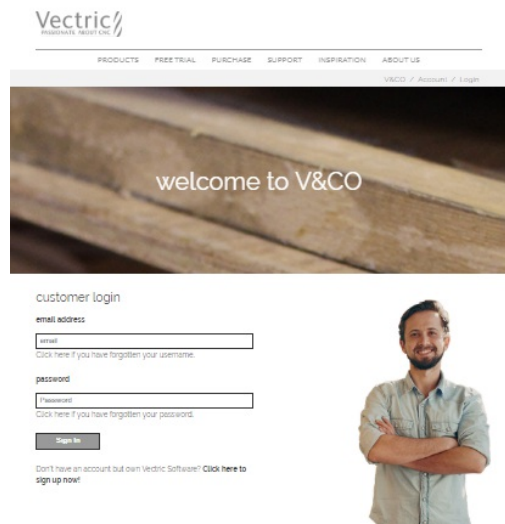

After logging in here with your V&Co account details another page may appear asking for permission for Cut2D Desktop to access your license details.

This page will only appear if you have not already granted access. If this appears you should select 'Allow' to enable Cut2D Desktop to retrieve your license details automatically.

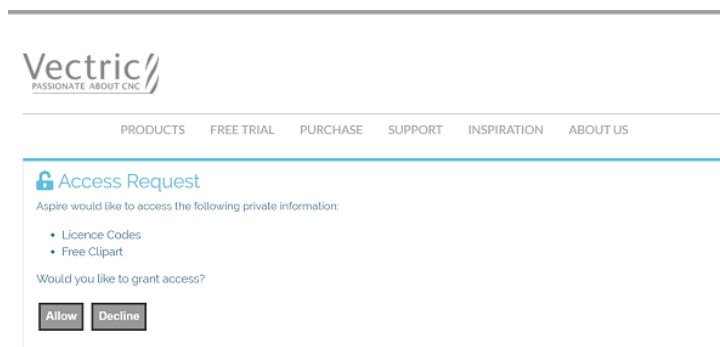

At this point Cut2D Desktop should be being displayed and the dialog should be automatically populated with any licenses available on your account.

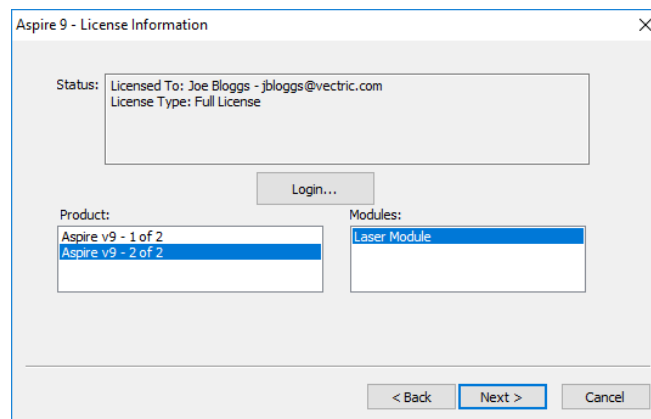

You can select any of the product licenses available and information on the type of license will be displayed in the status area. Once the license and any modules have been selected by clicking on them **Next >** can be pressed to activate these and proceed to the summary page.

**Note:** If there is only a single license available on your account the above page is skipped and the summary page (below) will already be displayed.

This page displays the selected license and module details. If you are changing current license details or adding a module a restart will be required for these to fully take effect. In this case a check box will appear allowing you to restart automatically. If this is checked then when you press **Finish** Cut2D Desktop will automatically be restarted to apply the license changes. If you do not select this option the license changes take effect the next time Cut2D Desktop is restarted.

## Manual Method

The manual method allows entry of license details without requiring an Internet connection. Selecting 'Manual' and clicking **Next >** will cause the manual entry form to be displayed.

The 'Registered User Name' from your license information should be entered into the 'Licensed To' area of the form and the license code can either be copied and pasted into the middle row of the dialog or manually typed into the lower section if 'Enter license code manually' is selected. The **Next >** button will become available when a code of the expected length has been entered.

If the product is already licensed then a module code can be entered at this stage instead of the product code. If you wish to manually activate both a product and module code the product code should be added here and there will be an opportunity to add the module code later. Pressing **Next >** will set the license and display the summary screen.

The summary screen shows the current licensed user and has an **Add Module** button to allow additional modules to be added. Pressing this button will display the manual entry form again and allow the module details to be entered.

If the licensed user is changed or a new module is added a restart will be required for these to take full effect. In this case a check box will appear allowing you to restart automatically. If this is checked then when you press the finish button the program will automatically be restarted to apply the license changes. If you do not select this option the license changes take effect the next time the program is restarted.

## View Controls

Your project is represented using 2D and 3D workspaces, each viewed via independent windows called the **2D View** and **3D View**, respectively. This division usefully maps to the typical workflow in which you will initially focus on the 2D design and layout of your project before moving to the 3D stage of modeling, toolpathing and previewing your finished part.

You can switch between the views using the tabs at the top of each window. In addition the shortcut-keys **F2** and **F3** will toggle the display between the two windows.





It is sometimes useful to see both the 2D and 3D representations at the same time. The **Page Up** and **Page Down** keys will arrange the 2 views either horizontally or vertically so you can see both workspaces simultaneously. To return to the tabbed display, simply click on the standard Windows Maximize button in the top right corner of either view window.

Many of the controls for manipulating the view in your project are similar in both 2D and 3D.









From within each view you can also directly interact with the objects that make up your job using the Object Selection Tools.

## 2D View Controls

See also the Rulers, Guides and Snap Grid section.

- 
Pan
Click and hold the Left mouse button and drag the mouse about to Pan - **Esc** to cancel mode
  
Shortcut: Click and drag the Middle mouse button or if using a 2 button mouse, Hold **Ctrl** + drag with Right Mouse button.
- 
Zoom
Mouse with Middle Wheel - Scroll wheel in / out
  
Interactive
Mouse without Middle Wheel - Hold **Shift** + Push / Pull with Right Mouse button.
- 
Zoom Box
Click top left corner, hold mouse down and drag to bottom right corner and release. Clicking the left mouse button will zoom in, **Shift** + click will zoom out.
- 
Zoom Extents
Zooms to show material limits in the 2D window
- 
Zoom Selected
With objects selected
  
Zooms to the bounding box of the selection

## 3D View Controls



- 
3D Twiddle
Click and drag Left mouse button in the 3D window
- 
Zoom
Right mouse button - Push / Pull
  
Mouse with Middle Wheel - Rotate wheel
- 
Pan
Click and drag Right mouse button and hold **Ctrl** .
  
Click and drag Right and Left mouse button
  
Click Middle mouse button
- 
Zoom to Fit
Zooms the whole 3D part to fit within the current 3D View window
- 
Isometric View
Shows the model in a 3D isometric view in the 3D window
- 
Plan View (Down Z)
Shows the top view of the model in the 3D View looking down the Z axis.
  
Press **Shift** to show the bottom.
- 
Side View (Along X)
Shows the side view of the model in the 3D View looking along the X axis.
  
Press **Shift** to show the opposite side.
- 
Side View (Along Y)
Shows the side view of the model in the 3D View looking along the Y axis.
  
Press **Shift** to show the opposite side.

## The View Toolbar







Above the view window is a handy toolbar that allows easier access to common tools. With the ability to create a double sided project you have easy access to switch between the Top and Bottom Sides of your project. The Layers Drop down bar has now moved from the drawing tab to the View Toolbar, making it accessible at all times. The other icons displayed in order of left to right are as follows:



### Snapping Toggle Options

-  Snap to geometry
-  Smart Snapping
-  Snap to Grid

### View Controls

-  Toggle Pan / Twiddle View
-  Zoom to box
-  Zoom to drawing
-  Zoom to selection



### Toolpath Drawing Toggle

-  Toggle 2D Toolpath Drawing
-  Toggle solid 2D Toolpath Drawing

### 3D Drawing

-  Toggle drawing of material block



### Tile 2D & 3D View Windows

-  Stack 2D and 3D View windows vertically
-  Stack 2D and 3D View windows horizontally

### Two-Sided Machining





When you are working on a two-sided job additional icons will appear on the View Toolbar. On the left you will see an icon indicating whether the job you are working on will be flipped horizontally or vertically. This is important because the software will automatically mirror your toolpaths and geometry around different axes depending on this setting. To maintain the correct alignment of your toolpaths you must physically turn the material on your CNC machine in the same direction as you have specified during the design process.

-  Turn horizontally from left to right.
-  Turn vertically, end over end.

**Note:** This icon is just for you information and does not perform any operation; it is not clickable.

The next button indicates which side you are currently working on. It is a toggle button that can be clicked. Clicking this button swaps the active side of your job.

-  Top side is active, all operations will apply to the Top side.
-  Bottom side is active, all operations will apply to the Bottom side.

**Note:** The rulers that border the 2D View are colored to provide a handy visual indicator as to which side is currently active. An **Orange background** indicates that the Bottom side is currently active and any drawing or toolpaths are associated with the Bottom Side of your design.

The final additional tool for two-sided job is on the right hand side of the View Toolbar and it allows you to toggle the 3D composite relief to show either the currently active side or your model only, or both sides of your model as a single solid block.

-  Toggle Two-Sided View

# The Drawing Tab

Cut2D Desktop includes drawing and editing tools that allow designs to be created and modified, which can ultimately be used directly for toolpath creation.

Commands for vector creation and editing are very easy to use and multiple design elements can also be drawn or imported, scaled, positioned and interactively edited to make a new design.

Text can also be created using any TrueType or OpenType fonts installed on your computer, or the single stroke engraving fonts supplied with the software.

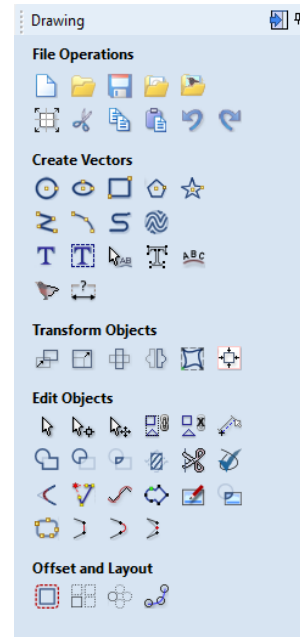

## File Operations

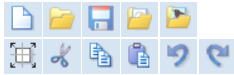

## New, Open and Save

-  This option opens the Job Setup form, which is used to create a new blank job of the specified dimensions and type. The relative origins for X0, Y0 and Z0 are also specified at this point, and the measurement units can be set in either inches or metric. The Modeling Resolution and default 3D shading color/material can also be set at this stage.
- Create a New File
-  This option opens the File Open dialog window, allowing Cut2D Desktop files (CRV) and importable 2D vector files to be selected and opened.
- Open a File
-  This option opens the File Save As dialog window and allows the job to be saved as a Cut2D Desktop file. Navigate to the required folder, enter a suitable name for the job and click the Save button.
- Save a File
-  This opens the File Open dialog window and allows 2D DXF, EPS and AI and PDF files to be imported into the 2D View. The imported vectors will always be read in at the size and scale they were created in their original design software. Once open they can be scaled and edited in the same way as vectors created in Cut2D Desktop. All the Vector tools will be dealt with in that section of this manual.
- Import Vectors
- To import toolpaths from PhotoVCarve and Cut3D (.PVC and .V3D file extensions) use **File ► Import... ► Import PhotoVCarve or Cut3D Toolpaths** from the main menu bar. Any Toolpath data saved as .PVC or .V3D files can be imported and will be visible in the Toolpath List.
-  This opens the File Open dialog window and allows image files to be selected and imported into the current open job. File types - BMP, JPG, TIF, GIF, PNG
- Import Bitmap
- Images are imported to sketch vectors over the top of them, generate traced vectors.

## File Types

- CRV** Files previously created and saved in Cut2D Desktop will be opened and displayed in the 2D Design window. All calculated toolpaths are stored/opened from the CRV file.
- DXF** Files from other CAD or graphics software packages such as AutoCAD will be opened in the original size and position. The Job Setup Form is automatically opened showing the maximum X and Y dimensions of the opened design. The actual size of the material can then be specified along with the required thickness and appropriate X0, Y0 and Z0 origins.
- DWG**
- EPS** Files from typical design software such as Corel Draw can be opened. The Job Setup form will automatically be opened so the required material size can be specified. By default the EPS file will be placed with the lower left corner of the design at X0, Y0.
- AI** Files from typical design software such as Adobe Illustrator and Corel Draw can be opened. The Job Setup form will automatically be opened so the required material size can be specified. The AI file will be placed with the lower left corner of the design at X0, Y0
- PDF** Software such as the Adobe product range can be used to convert files from other design and word processing software into the industry standard PDF file format. The text and vector content of PDF files is extracted when imported into Cut2D Desktop. When importing multiple page PDF documents each page is placed on a separate layer.
- SKP** SketchUp files with a .SKP extension (see [www.sketchup.com](http://www.sketchup.com)) can be imported as 2D data suitable for machining. See the Sketchup section for detailed instructions on importing Sketchup files.

## SketchUp Files



SketchUp files with a .SKP extension (see [www.sketchup.com](http://www.sketchup.com)) can be imported as 2D data suitable for machining into a Cut2D Desktop job using the **File ► Import Vectors...** command from the menu bar or the import vectors  icon on the Drawing tab. To import data from a SketchUp file you must already have created or opened a job to import the data into.

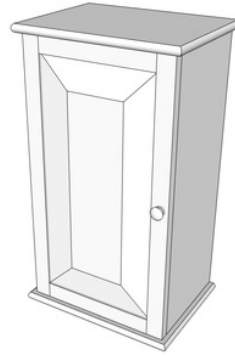

As a SketchUp model is usually a 3D representation of the part, the SketchUp importer offers a number of options to allow you to start manufacturing the model.

We will illustrate the two main choices for how the model will be imported using the SketchUp model shown to the left.

The model shown in the screenshots is a cabinet constructed by following the instructions in the Fine Woodworking 'Google SketchUp guide for Woodworkers: The Basics' DVD which is available via the Fine Woodworking site at [www.finewoodworking.com](http://www.finewoodworking.com). Vectric have no affiliation with Fine Woodworking, we are just using screenshots of the model constructed while following their tutorials to illustrate the process of importing a SketchUp model.

When the SketchUp model is selected from the File Import dialog, the following dialog will be displayed.

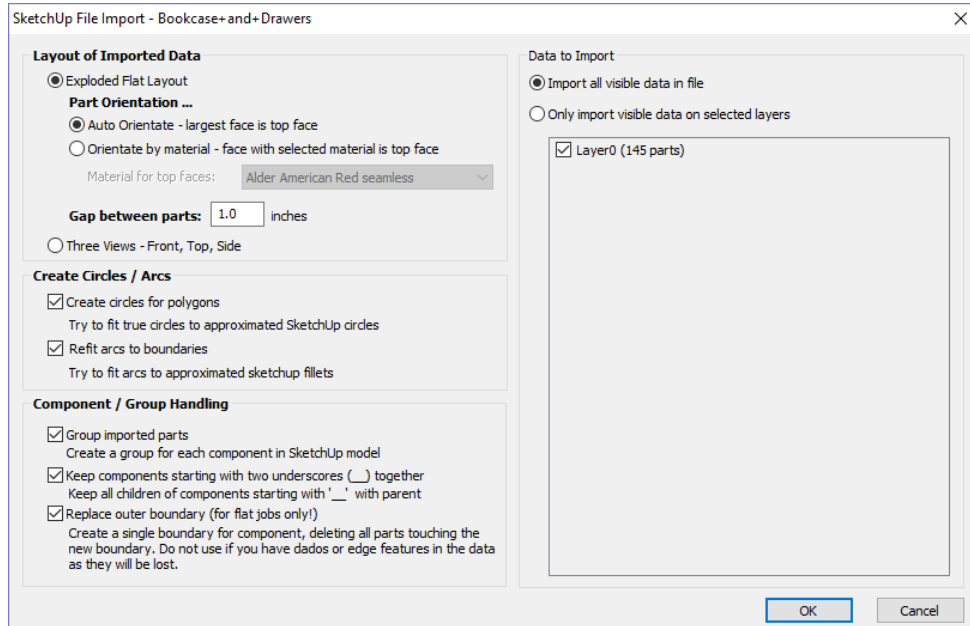

Although this initially looks complex, the dialog is divided into four logical sections which will be describe below.

## Layout of Imported Data

In the first section there are two main choices for how the data from the model will be imported, 'Exploded Flat Layout' and 'Three Views - Front, Top, Side' as shown below.

We will describe the 'Three Views - Front, Top, Side' option first as it is the simplest.

### Three Views - Front, Top, Side

This option will create an 'engineering drawing' style layout of the SketchUp model as shown in the screenshot below.

The size of the model is preserved and it is relatively simple to pick up dimensions for parts you are going to manufacture from the various views. The colors of the lines you see are taken from the colors of the original SketchUp layers the various parts of the model are on.

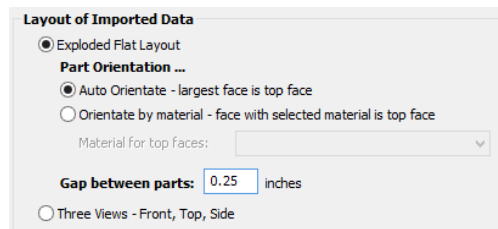

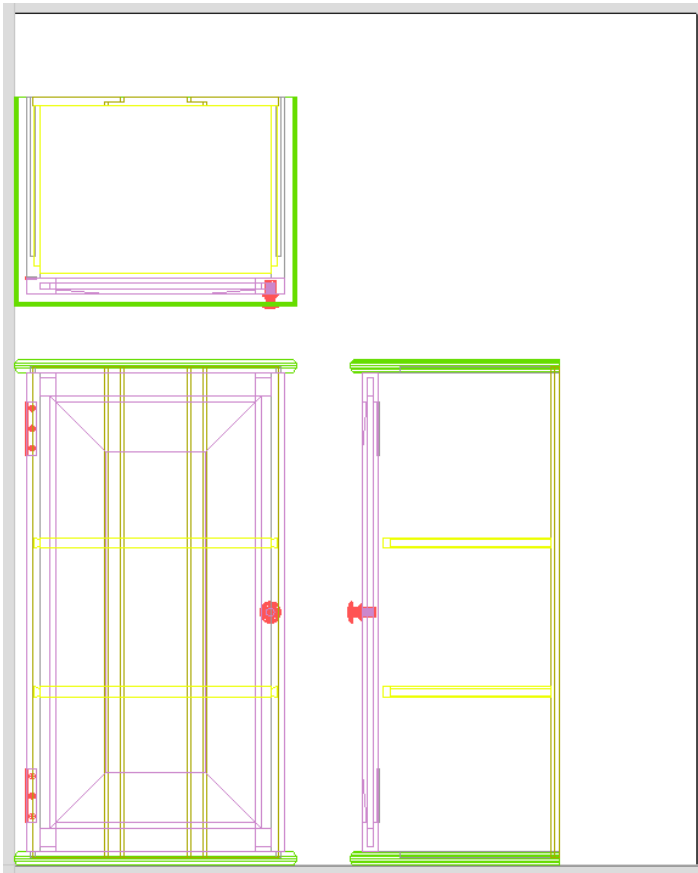

**Exploded Flat Layout**

This option will take each component in the model and orientate it flat ready for machining as shown in the screenshot below.

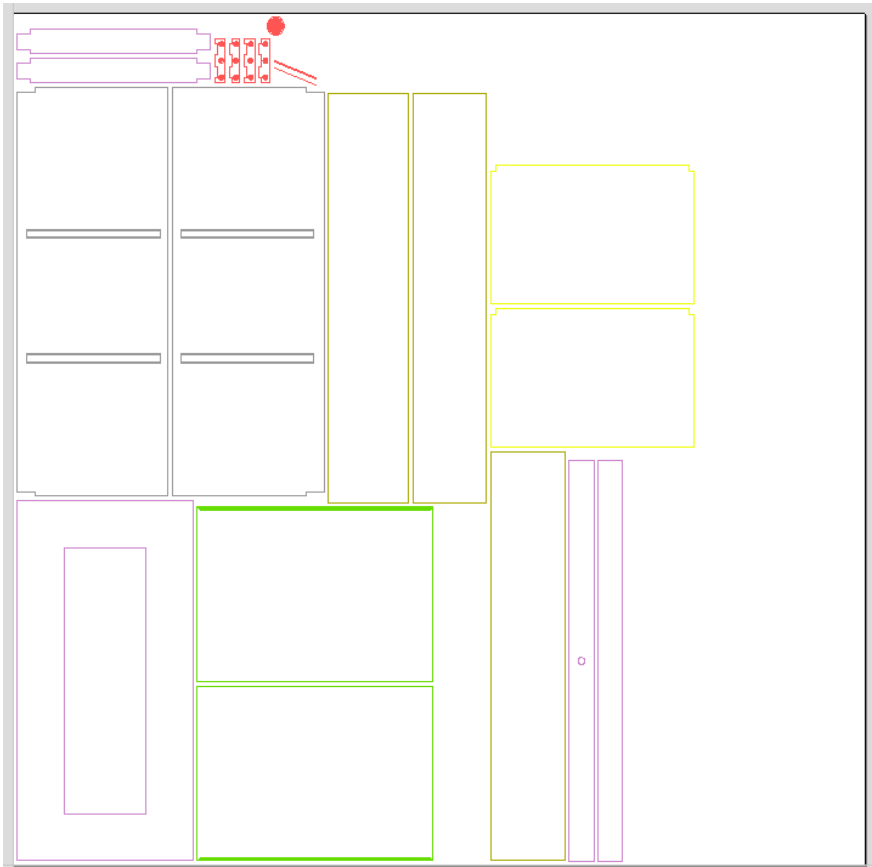

Once this option is selected a number of sub-options also become available.

**Part Orientation**

This section controls what Cut2D Desktop considers to be the 'top' face of each part.

### Auto Orientate

If this option is selected, for each part in the model, the 'face' with the largest area based on its outer perimeter (i.e. ignoring holes etc.) is considered to be the 'top' face and the part is automatically rotated so that this face is facing upwards in Z. This strategy works very well for models which are to be manufactured from sheet goods where there are no features on particular faces which need to be on the 'top' (such as pockets).

### Orientate by material

This option allows the user to control more explicitly the orientation of each part in the model. Within SketchUp the user can 'paint' the face of each component/group with a material/color of their choice to indicate which face will be orientated on top when the model is imported. When this option is selected simply chose the material which has been used to indicate the top face from the drop down list. If a part is found in the model which does not have a face with the specified material, that part will be orientated by making the largest face the top.

### Gap between parts

This field lets the user specify the gap between parts when they are first imported. After importing, the nesting functions within Cut2D Desktop can be used to layout the parts with more control and across multiple sheets.

### Create Circles / Arcs

SketchUp does not maintain true arc or circle information for the boundaries of its parts. This is a problem when it comes to machining as the 'polygonal' SketchUp representation can give very poor machining results. For this reason, Cut2D Desktop offers the option to refit circles and arcs to imported data.

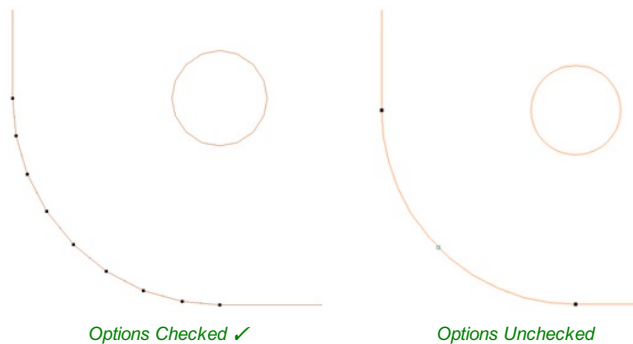
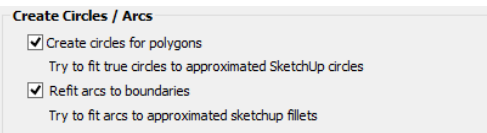

The screenshot above left shows the results of importing a part with a filleted corner and hole with these options unchecked. The 'fillet' is made up of a series of straight line segments and the circular 'hole' is actually a polygon made up of straight lines.

The screen shot above right shows the same part imported with both these options checked ✓. The 'fillet' now consists of a single smooth arc and the circular 'hole' now also consists of arcs rather than straight line segments. Both these features will machine more cleanly in this form.

### Data to Import

A SketchUp model will often contain parts that you do not wish to machine (such as hinges, knobs etc.) or data which will be cut from different thicknesses of material and hence different parts need to be imported into different Cut2D Desktop jobs. To allow control over what is imported you can choose to only import parts of the model which are on particular layers using this section of the dialog.

To only import data from selected layers, choose the 'import visible data on selected layers' option and click the check box next to each layer to indicate if you want to import data from that layer. Note that the number of parts on each layer is displayed next to the layer name.

It is very easy to assign different parts of the model to different layers within SketchUp to help with the import process into Cut2D Desktop. The screenshot below shows the result of only importing data on the 'Door' layer from the example.

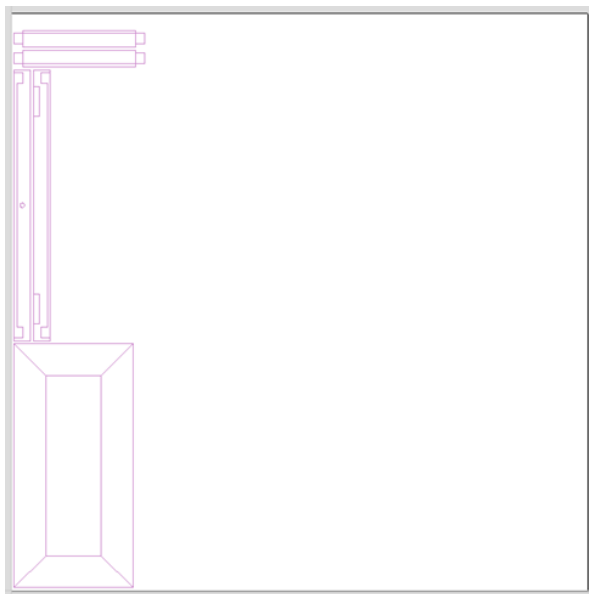
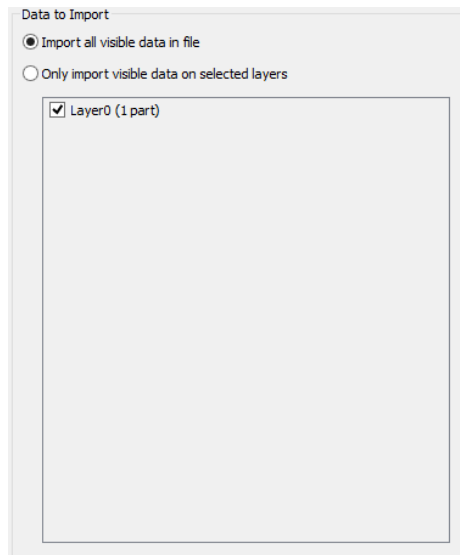

As long as the 'Group imported parts' option is selected, these parts can then be easily nested ready for machining as shown in the image below (the 'Group imported parts' option is explained later in this section).

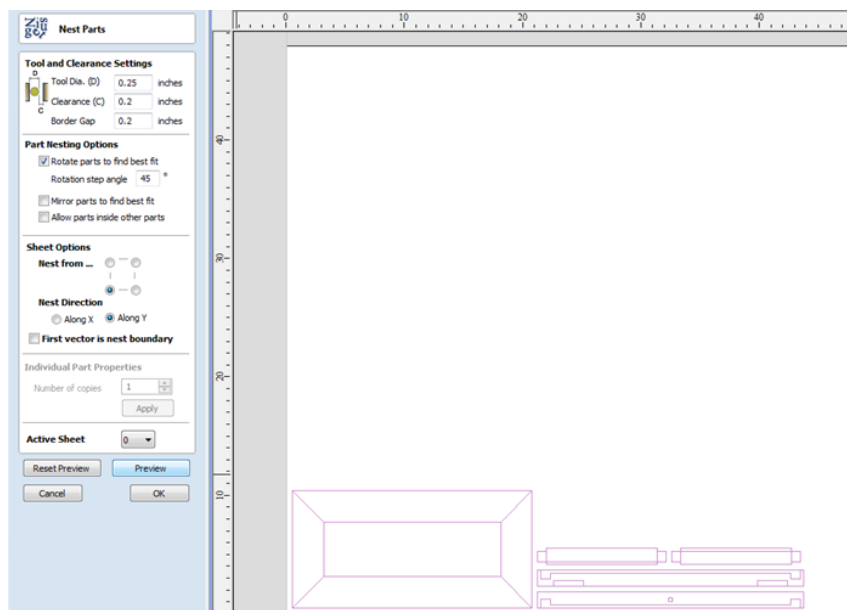

## Component / Group Handling

This section of the form allows advanced handling of how 'parts' within the SketchUp model are identified and treated on import.

#### Component / Group Handling

- Group imported parts  
Create a group for each component in SketchUp model
- Keep components starting with two underscores (\_\_) together  
Keep all children of components starting with '\_' with parent
- Replace outer boundary (for flat jobs only!)  
Create a single boundary for component, deleting all parts touching the new boundary. Do not use if you have dados or edge features in the data as they will be lost.

### Group imported parts

This option is normally selected for all but the simplest models as it allows each 'part' of the model to be selected, moved and nested easily after import. You will need to ungroup the imported data after nesting etc. to allow individual features to be machined. By default, Cut2D Desktop will treat each SketchUp group / component as a single part UNLESS it contains other groups or components within it, in which case each lowest level group / component will be treated as a separate part.

Items which you retain in groups can be ungrouped at any time in the usual ways.

If the right-click menu-option to **Ungroup back onto original object layers** is used (which is the default option when using the icon or shortcut  $\cup$ ) then the software will place the ungrouped items back onto the original layers they were created on in SketchUp.

### Keep components starting with two underscores (\_\_) together

If you have a complex model which contain 'parts' which are made up of other groups / components, you will need to do some work on your model to identify these parts for Cut2D Desktop. The way this is done is by setting the name of the groups / components that you wish to be treated as a single part to start with \_\_ (two underscore characters). For example, if you had a model of a car and you wanted the wheels / tires / hub nuts to be treated as a single part even though the Tire, Wheel and other parts were separate components, you would group the parts together and name them something like \_\_WheelAssembly in SketchUp. When this model was imported, and Cut2D Desktop reached the group/component with a name starting with \_\_ it would treat all subsequent child objects of that object as being the same part.

### Replace outer boundary (for flat jobs only!)

There is a style of 'building' with SketchUp where individual 'parts' are made up of several components 'buted' against each other. The screenshot below shows such a component.

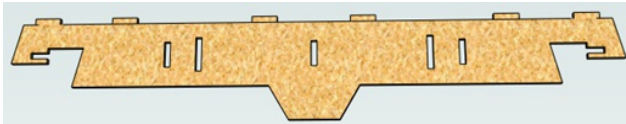

This object is made up of many smaller components representing the tabs on the top, the connectors at the end and the support at the bottom as shown below.

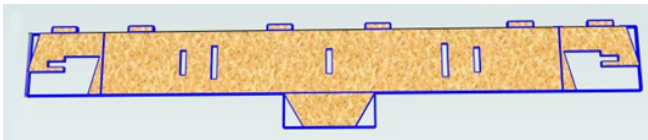

Although when can treat this as a single 'part' when imported by starting its name with \_\_ (two underscores), the imported part is still going to be difficult to machine. The screenshot below shows the part imported into Cut2D Desktop without the 'Replace outer boundary' option checked  $\checkmark$ . The part in the image has been ungrouped and the central vector selected.

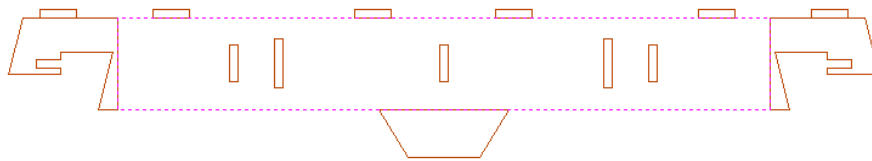

As you can see, the outer boundary is made up of separate segments for each 'feature'. Cut2D Desktop does have the ability to create an outer boundary for vectors but this can be time consuming if it has to be done manually. If the 'Replace outer boundary' option is checked,  $\checkmark$  for every part Cut2D Desktop will try to create a single outer boundary and delete all the vectors which were part of this boundary. The screenshot below shows the result of importing the same data with this option checked,  $\checkmark$  this time the part has been ungrouped and the outer vector selected.

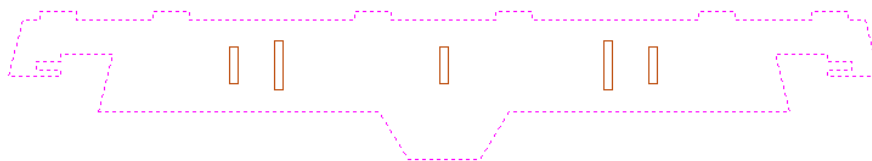

This data is now ready to be machined directly. It is important to understand the limitations of this option. It can be substantially slower. Creating robust boundaries for each part can consume a lot of processing power. Any feature which shares an edge with the boundary will be deleted. If the tabs on the top of this part were to have been machined 'thinner', this approach would not have been suitable as the bottom edge of the tabs has been removed.

**IMPORTANT**

The new features will help a lot of SketchUp users dramatically reduce the time it takes to go from a SketchUp design to a machinable part using Cut2D Desktop.

It is important to understand though that while these options provide a useful set of tools, in many cases there will still be additional editing required to ensure the part is ready to toolpath.

Understanding the options and how they work will allow the part to be designed in SketchUp with these in mind and therefore help to minimize the time to machine once the data is imported.

**Note:** Sketchup files will only open in the same bit version you are running e.g. A file saved in a 32 bit version of Sketchup will only open up in a 32 bit version of Cut2D Desktop.

## PDF Export

The PDF Export form allows vectors within your drawings to be exported into PDF format.

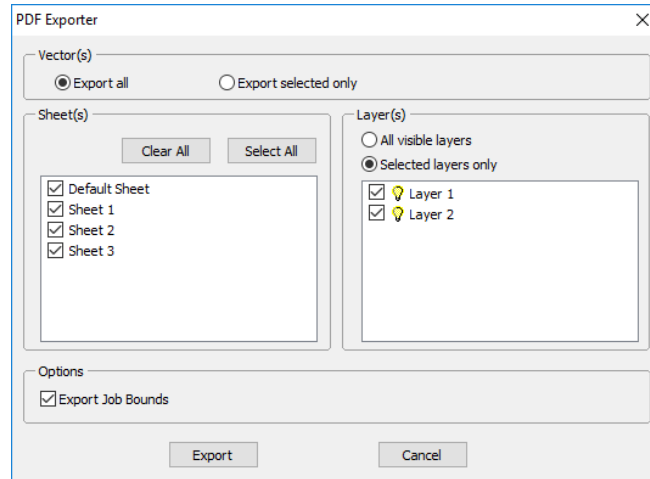

### Vector(s)

Selecting **Export All** will export all of the vectors contained on the specified sheets and layers.

Selecting **Export Selected Only** will export only the vectors which are currently selected and on the specified sheets and layers.

### Sheets

The sheets you wish to be exported to PDF can be selected from within this section. Clicking **Clear All** will deselect all of the sheets and clicking **Select All** will cause all of the sheets to become selected. You can also manually select/deselect individual sheets by clicking on the check box to the left of the sheet name.

**Note:** Each sheet will be saved as a separate page within the PDF file.

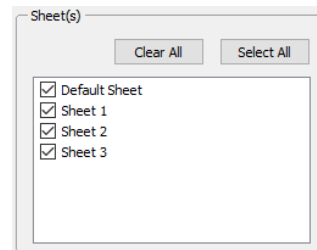

### Layers

The layers you wish to be exported to PDF can be selected from within this section. All the visible layers with content on them will show up in this list.

When **All visible layers** is chosen all of the vector layers will be selected. Only vectors on the layers selected will be exported into the PDF file. When **Selected layers only** is chosen individual layers can be manually selected/deselected by clicking on the check box to the left of the layer name.

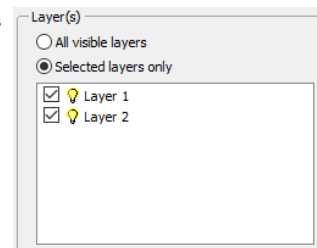

### Options

Export Job Bounds - If this option is selected a vector representing the boundary of the job will also be output to the PDF file.

Clicking **Export** will prompt you to choose a filename and location for your file and save your drawing in PDF format at that location.

## Cut, Copy and Paste

The Cut, Copy and Paste functions in Cut2D Desktop can be used on Vectors or Bitmaps.



Cut

The Cut tool removes the selected objects from a design in a similar way to pressing the Delete key, but the selected objects are copied to the clipboard and can be Pasted into either the current file or a new file if required. Only one item can be Cut or Copied at a time.



Copy

The Copy tool copies selected objects to the clipboard, leaving the original in place and allows duplicates to be made and re-used in the design by pressing the Paste icon. Only one item can be Cut or Copied at a time.



Paste

This Paste option places the contents of the clipboard (created by Cut or Copy) into the design, allowing elements to be re-used in different areas of a design or in other Cut2D Desktop parts.



Undo

Clicking this option steps backwards through the design changes made by the user.



Redo

Clicking this option steps forward through design steps that have been Undone using the Undo command (see above) to get back to stage that the user started using the Undo function.

## Job Setup



The Job Setup form is displayed whenever a new job is being created, or when the size and position of an existing job is edited. It allows to create following types of job:

- Single Sided
- Double Sided

### Job Setup - Single Sided



The Job Setup form is displayed whenever a new job is being created, or when the size and position of an existing job is edited.

### Job Type

**Single Sided** job type should be used when design only requires the material to be cut from one side. This is the simplest type of job to design and machine.

For more information about **Double Sided** job type see Job Setup - Double Sided.

### Job Size

This section of the form defines the dimensions of the material block you will be using for your project in terms of width (along the X axis), height (along the Y axis) and thickness (along the Z axis).

It also allows you to select which units of measurement you prefer to design in - either inches (Imperial/English) or millimeters (Metric).

**Note:** Cut2D Desktop only supports job sizes up to a maximum of 25 inches square without tiling.

You can cut jobs larger than this limit but you will need to use the Toolpath Tiling feature to cut the job in sections.

### Z Zero Position

Indicates whether the tip of the tool is set off the surface of the material (as shown in the diagram) or off the bed / table of the machine for Z = 0.0.

### XY Datum Position

This datum can be set at any corner, or the middle of the job. This represents the location, relative to your design, that will

**Job Setup**

**Job Type**

Single Sided  
 Double Sided  
 Rotary

**Job Size**

Width (X): 10.0 inches  
 Height (Y): 10.0 inches  
 Thickness (Z): 0.5 inches

**Units**

inches  mm

**Z Zero Position**

Material Surface  
 Machine Bed

**XY Datum Position**

Use Offset  
 X: 0.0  
 Y: 0.0

**Design Scaling**

Scale design with job size

OK Cancel

**Job Setup**

**Job Type**

Single Sided  
 Double Sided  
 Rotary

**Job Size**

Width (X): 10.0 inches  
 Height (Y): 10.0 inches  
 Thickness (Z): 0.5 inches

**Units**

inches  mm

**Z Zero Position**

Material Surface  
 Machine Bed

**XY Datum Position**

Use Offset  
 X: 0.0  
 Y: 0.0

**Design Scaling**

Scale design with job size

OK Cancel

match the machine tool when it is positioned at X0, Y0. While this form is open, a red square is drawn in the 2d view to highlight the datum's position.

## Use Offset

This option allows the datum position to be set to a value other than X0, Y0.

## Design Scaling

**Note:** This section of the form is only visible when editing and *existing* job, **not** when creating a new job.

**Design Scaling**

Scale design with job size

When editing the Job Size parameters of an existing job, this option determines whether any drawings you have already created will be scaled *proportionally* to match the new job dimensions. If you wish to preserve the existing size of your drawings, even after the job size has changed, leave this option unchecked. With this option checked, your drawings will be re-sized to remain in the same proportion and relative position within your new material extents when you click **OK**.

## Job Setup - Double Sided



The Job Setup form is displayed whenever a new job is being created, or when the size and position of an existing job is edited.

### Job Type

**Double Sided** job type is useful when it is desired to cut *both sides* of your material. Cut2D Desktop allows you to visualise and manage the creation and cutting process of both sides of your design within a single project file.

**Note:** For a overview of double sided machining see Two-Sided Machining.

For more information about **Single Sided** job type see Job Setup - Single Sided.

### Job Size

This section of the form defines the dimensions of the material block you will be using for your project in terms of width (along the X axis), height (along the Y axis) and thickness (along the Z axis).

It also allows you to select which units of measurement you prefer to design in - either inches (Imperial/English) or millimeters (Metric).

**Note:** Cut2D Desktop only supports job sizes up to a maximum of 25 inches square without tiling. You can cut jobs larger than this limit but you will need to use the Toolpath Tiling feature to cut the job in sections.

**Job Setup**

**Job Type**

Single Sided  
 Double Sided  
 Rotary

**Job Size**

Width (X): 10.0 inches  
Height (Y): 10.0 inches  
Thickness (Z): 0.5 inches

**Units**  inches  mm

**Z Zero Position**

Material Surface  
 Machine Bed  
 Zero off same side

**XY Datum Position**

Use Offset  
X: 0.0  
Y: 0.0

**Flip Direction Between Sides**

**Design Scaling**

Scale design with job size

**OK** **Cancel**

## Z Zero Position

Indicates whether the tip of the tool is set off the surface of the material (as shown in the diagram) or off the bed / table of the machine for Z = 0.0.

### Zero off same side

This option allows Z Zero to reference *the same physical location*, regardless whether material is flipped or not

## XY Datum Position

This datum can be set at any corner, or the middle of the job. This represents the location, relative to your design, that will match the machine tool when it is positioned at X0, Y0. While this form is open, a red square is drawn in the 2d view to highlight the datum's position.

## Use Offset

This option allows the datum position to be set to a value other than X0, Y0.



## Flip Direction Between Sides

This section gives choice between horizontal and vertical flipping when changing machining side. Cut2D Desktop uses that information to correctly manage the alignment of the geometry relating to each side.

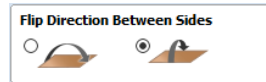

## Design Scaling

**Note:** This section of the form is only visible when editing and *existing* job, **not** when creating a new job.



When editing the Job Size parameters of an existing job, this option determines whether any drawings you have already created will be scaled *proportionally* to match the new job dimensions. If you wish to preserve the existing size of your drawings, even after the job size has changed, leave this option unchecked. With this option checked, your drawings will be re-sized to remain in the same proportion and relative position within your new material extents when you click  .

# The Create Vectors Tool Group

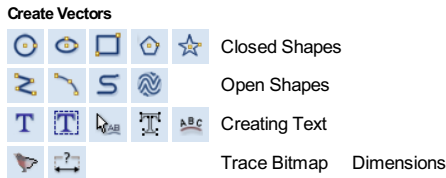

## Drawing Shapes

Each tool gives you the option of dynamically drawing with the mouse in the 2D View, or entering precise data using the form. When you click on a shape tool icon its associated form will open on the Drawing tab. Here you can see the precise dimensions of the shape you are working on, which you can edit directly, as well as other options specific to the type of shape you are editing.

If you click on a shape drawing tool when nothing is selected in the 2D View, you will be able to create new shapes using the **Create** button. If you select a previously created shape, you will be able to modify its properties using the same form and update the shape using the **Apply** button.

**Note:** Pressing the **Space-bar** re-opens the last vector creation form you used. This is very useful when using other forms in between each shape you create.

## Creating Text

There are a number of tools dedicated to the creation and editing of text. These can be found on the Drawing tab, below the shape creation tools.

Cut2D Desktop can make use of any TrueType font already installed on your computer, as well as Vectric's own single-line fonts designed specifically for CNC machining.

Use the Draw Text, or Draw Auto Text, to create text within your design. The Text selection tool then allows you to dynamically alter the text positioning, spacing or even to bend your text into an arc. For even more flexibility, use the Text on Curve tool to place your text along any vector curve or line that you have drawn. The Convert Text to Curves tool allows you to then use Node Editing to fine tune the vectors of the text to any shape required.

The text tools are accessed using the following icons:



## Trace Bitmap

Trace Bitmap tool allows you to automatically trace imported bitmaps using a variety of options within the tool to control the vectors that are created.

## Dimensions

The dimensions tool allows you to add a variety of dimensioning annotations to your vector drawing.

## Draw Circle



Circles can be created interactively with the cursor and Quick Keys or by entering the exact coordinates and diameter / radius with typed input.

**Note:** Pressing the **Space-bar** re-opens the last vector creation form you used. This is very useful when using other forms in between each shape you create.

## Interactive

### Cursor

The default mode and the procedure for drawing circle is:

Click and drag the Left mouse to indicate the center point followed by releasing the button at the required radius / diameter (depends on what is set on the form).

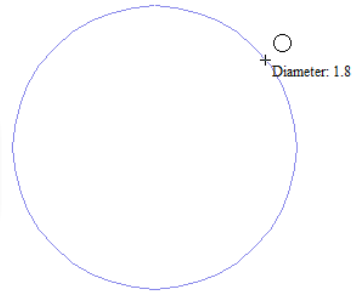

**Note:** Holding **Alt** and dragging creates a circle from the *middle* point.

As the cursor is dragged across the screen the radius is dynamically updated. The increments will depend upon your snap radius and the job size.

## Quick Keys

The radius or diameter can be specified while dragging out a circle:

Type the value while dragging followed, by **D** if it's a diameter, or **R** if it's a radius:

Keys	Result
1 2 R	Radius 12
2 R	Radius 2
1 D	Diameter 1

## Exact Size

Circles can also be drawn by entering the required XY origin, selecting either **Radius** or **Diameter** and entering the required size on the form.

Click **Create** to update the circle.

## Edit

Open the **Draw Circle** form and select the circle to modify.

The selected circle is displayed as a dotted **magenta** line. Edit the **Center Point** and **Radius** or **Diameter**

Click **Apply** to update the circle

To modify another circle without closing the form hold a **Shift** key down and select the next circle.

## Close the form

To finish drawing with the tool, you can:

- Click **Close** on the form
- Press the **Esc** key
- Click the Right mouse button in the 2D View.

## Draw Ellipse



Ellipse / ovals can be created interactively with the cursor and Quick Keys or by entering the exact coordinates for the center point, height and width with typed input.

**Note:** Pressing the **Space-bar** re-opens the last vector creation form you used. This is very useful when using other forms in between each shape you create.

**Draw Ellipse**

**Anchor Point**

X:  Y:

**Size**

Width (X)  inches

Height (Y)  inches

To edit an existing shape  
hold shift while selecting

## Interactive - Cursor

The quickest and simplest way to draw an ellipse is:

- Click and drag the left mouse button in the 2D View to begin drawing the ellipse from its corner.
- While holding the left mouse button, drag to the required size.
- Releasing the left mouse button.



**Note:**

Holding **Alt** and dragging creates an ellipse from the *middle* point.

Holding **Ctrl** and dragging creates a *circle*.

## Quick Keys

Instead of releasing the left mouse button when you have dragged your shape to the required size, you can also type exact values during the dragging process and set properties precisely.

- Left-click and drag out your shape in the 2D View.
- With the left mouse button still pressed, enter a quick key sequence detailed below.
- Release the left mouse button.

## Default

By default, two values separated by a comma, will be used to set width and height of your ellipse. One value will create a circle with the given diameter. While you are dragging out the ellipse, type **Width Value** , **Height Value** Enter or **Diameter** , Enter to create an ellipse with the specified dimensions.

## Example

Keys	Result
2 . 5 , 1 Enter	Creates ellipse with a width of 2.5 and a height of 1.

## Specifying Further Properties

By using specific letter keys after your value, you can also indicate precisely which property it relates to.

Quick Keys	Result
<b>Value</b> X	Creates an ellipse at the current dragged height, but with the width set to the entered value.
<b>Value</b> Y	Creates an ellipse at the current dragged width, but with the height set to the entered value.
<b>Value</b> W <b>Value</b> H	Creates an ellipse with a specified width (W) and height (H).

## Examples

Keys	Result
1 X	Current dragged height with width (X) of 1.
1 Y	Current dragged width and height (Y) of 1.
1 W 2 H	A width (W) of 1 and height (H) of 2.

**Note:** These key combinations must be pressed whilst dragging with the mouse to create the ellipse.

## Exact Size

Accurate ellipses can also be drawn by entering the required XY origin point with the Width and Height of the oval. Click  to create the ellipse.

## Edit

- Select the ellipse to modify and open the **Draw Ellipse** form.
- The selected shape is displayed as a dotted magenta line.
- Edit the Width and Height values.
- Click  to update the ellipse.

To modify another ellipse without closing the form hold a **Shift** key down and select the next ellipse.

## Close the form

To finish drawing with the tool, you can:

- Click **Close** on the form
- Press the **Esc** key
- Click with the Right-mouse button in the 2D View

## Draw Rectangle



Rectangles can be created by using the Draw Polyline tool or using the Draw Rectangle Tool. The Draw Rectangle Tool allows rectangles to be created interactively with the cursor and Quick Keys or by entering the exact coordinates, type of corners (square, internal or external radius) and Width and Height using typed input.

**Note:** Pressing the **Space-bar** re-opens the last vector creation form you used. This is very useful when using other forms in between each shape you create.

**Draw Rectangle**

**Anchor Point**

X: 6.1667 Y: 5.25

**Corner Type**

Square  
 Radiused External  
 Radiused Internal

Radius: 0.25 inches

**Size**

Width (X): 10.3333 inches  
Height (Y): 8.4999 inches

To edit an existing shape hold shift while selecting

Create Close

## Interactive - Cursor

The quickest and simplest way to draw a rectangle is:

-  Click and drag the left mouse button in the 2D View to begin drawing the rectangle from its first corner.
- While holding the left mouse button, drag to the required size.
- Releasing the left mouse button.

### Note:

Holding **Alt** and dragging creates a rectangle from the *middle* point.

Holding **Ctrl** and dragging creates a *square*.

As the cursor is dragged across the screen so the XY size is dynamically updated. The increments will depend upon your snap radius and the job size.

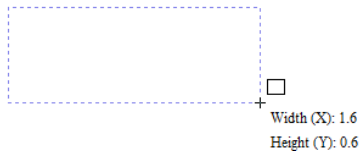

## Quick Keys

Instead of releasing the left mouse button when you have dragged your shape to the required size, you can also type exact values during the dragging process and set properties precisely.

-  Left-click and drag out your shape in the 2D View.
- With the left mouse button still pressed, enter a quick key sequence detailed below.
- Release the left mouse button.

## Default

By default, **two values** separated by a comma, will be used to set width and height of your rectangle. **One value** will create a square with that side length. While you are dragging out the rectangle corner, type **Width Value** , **Height Value** Enter or **Side Length** , Enter to create a rectangle with the specified width and height.

## Example

Keys	Result
1 , 2 . 5 Enter	Creates rectangle with a width of 1 and a height of 2.5.

## Specifying Further Properties

By using specific letter keys after your value, you can also indicate precisely which property it relates to.

Quick Keys	Result
<b>Value</b> X	Creates a rectangle at the current dragged height, but with the width set to the entered value.
<b>Value</b> Y	Creates a rectangle at the current dragged width, but with the height set to the entered value.
<b>Value</b> R <b>Value</b> X	Creates a rectangle with a radius (R) and width (X) set by the two entered values, but using the currently dragged height.
<b>Value</b> R <b>Value</b> Y	Creates a rectangle with a radius (R) and height (Y) set by the two entered values, but using the currently dragged width.
<b>Value</b> W <b>Value</b> H	Creates a rectangle with a specified width (W) and height (H). No radiused corners.
<b>Value</b> R <b>Value</b> W <b>Value</b> H	Create a rectangle with radius (R), width (W) and height (H) all specified by the entered values.

**Note:** When specifying multiple properties with quick keys, it is still important that they are entered in the *order* indicated in the table above.

## Examples

Keys	Result
1 X	Current dragged height with width (X) of 1.
1 Y	Current dragged width and height (Y) of 1.
0 . 1 R 1 X	A corner radius (R) of 0.1, a width (X) of 1 and the current dragged height.
0 . 1 R 1 Y	A corner radius (R) of 0.1, a height (Y) of 1 and the current dragged width.
1 W 2 H	A width (W) of 1 and height (H) of 2, no corner radius.
0 . 1 R 1 W 2 H	A corner radius (R) of 0.1, width (W) of 1 and height (H) of 2

**Note:** These key combinations must be pressed whilst dragging with the mouse to create the rectangle.

## Exact Size

Rectangles can also be drawn by entering the required XY origin point with the Width and Height of the rectangle.

## Corner Type

Corners of the rectangle can be **Square**, **Radiused Externally** or Radiused **Internally**.

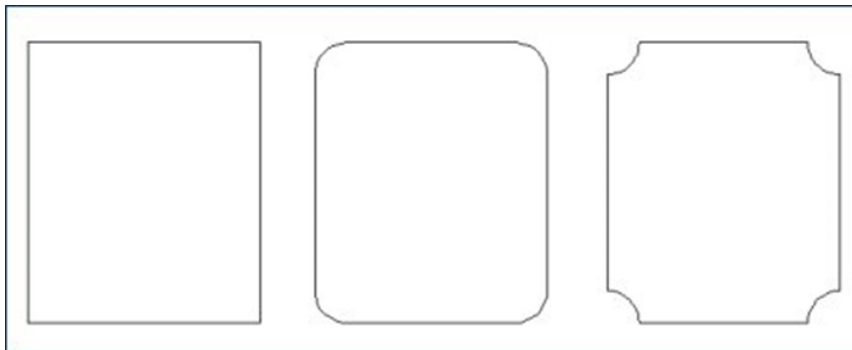

## Edit

- Select the rectangle to modify and open the **Draw Rectangle** form.
- The selected shape is displayed as a dotted magenta line.
- Edit the Width and Height values.
- Click  to update the rectangle.

To modify another rectangle without closing the form hold a **Shift** key down and select the next rectangle.

If you hold a **Shift** key down and select an object that isn't a rectangle (so if you click text or a polyline, for example) a Rectangle will be created as a bounding box of the clicked object:

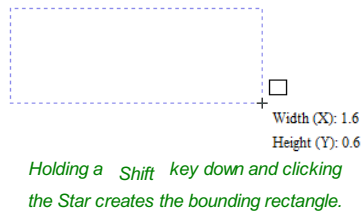

**Note:** When the Draw Rectangle form is opened with a selection (that is not a single horizontal or vertical line) the form properties will be set to the bounding box of that selection (which may contain multiple objects). Just click **Create** to draw the bounding box. You could then offset this box to have an even boundary around the selection.

### Close the form

To finish drawing with the tool, you can:

- Click **Close** on the form
- Press the **Esc** key
- Click the Right mouse button in the 2D View.

## Draw Polygon



Polygons (e.g. Triangles, Pentagons, Hexagons etc.) can be created interactively with the cursor and Quick Keys or by entering the number of sides, exact coordinates and radius using typed input.

**Note:** Pressing the **Space-bar** re-opens the last vector creation form you used. This is very useful when using other forms in between each shape you create.

**Draw Polygon**

**Number of Sides**

**Center Point**  
 X:  Y:

**Radius**  
 inches

To edit an existing shape hold shift while selecting

**Create** **Close**

### Interactive - Cursor

The quickest and easiest way to draw a polygon is by using the mouse in the 2D View.

- Click and hold the left mouse button to indicate the center point.
- Drag the mouse while holding down the left mouse to required radius.
- Release the left mouse button to complete the shape.

**Note:** Holding **Alt** and dragging creates a Polygon from the *middle* point.

As the cursor is dragged across the screen so the radius is dynamically updated. The increments will depend upon your snap radius and the job size.

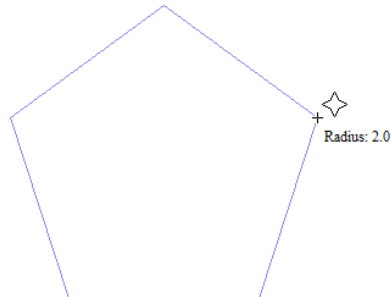

### Quick Keys

Instead of releasing the left mouse button when you have dragged your shape to the required size, you can also type exact values during the dragging process and set properties precisely.

- Left-click and drag out your shape in the 2D View.
- With the left mouse button still pressed, enter a quick key sequence detailed below.
- Release the left mouse button.

### Default

By default, entering a single values will be used to set the radius of your polygon. While you are dragging out the polygon, type **Radius Value** Enter to create a polygon with the precisely specified radius.

## Example

Keys	Result
2 . 5 Enter	Creates a polygon with a radius of 2.5, all other settings as per the form.

## Specifying Further Properties

By using specific letter keys after your value, you can also indicate precisely which property it relates to.

Quick Keys	Result
<b>Value</b> D	Creates a polygon with the <b>diameter</b> (D) specified, with all other properties as per the form.
<b>Value</b> S <b>Value</b> R	Creates a polygon with the specified number of sides (S) and the outer radius (R).
<b>Value</b> S <b>Value</b> D	Creates a polygon with the specified number of sides (S) and the outer diameter (D).

## Examples

Keys	Result
1 R	Outer radius (R) 1, number of sides as per form.
1 D	Outer diameter (D) 1, number of sides as per form.
8 S 1 R	An 8 sided (S) polygon with an outer radius (R) of 1.
6 S 2 . 5 D	A 6 sided (S) polygon with an outer diameter (R) of 2.5.

**Note:** These key combinations must be pressed whilst dragging with the mouse during shape creation.

## Exact Size

Polygons can also be drawn by entering the required XY origin ,selecting either **Radius** or **Diameter** and entering the required size.

- Click  to update the circle.

## Edit

Open the **Draw Polygon** form and select the circle to modify.

The selected circle is displayed as a dotted **magenta** line.

- Edit the **Number of Sides** and **Radius**.
- Click  to update the circle.

To modify another polygon without closing the form hold the **Shift** key down and select the next polygon.

## Close the form

To finish drawing with the tool, you can:

- Click  on the form
- Press the **Esc** key
- Click the Right mouse button in the 2D View.





## Draw Star

Stars can be created interactively with the cursor and Quick Keys, or by entering the number of points, exact coordinates and outer radius and inner radius percentage using typed input.

**Note:** Pressing the Space-bar re-opens the last vector creation form you used. This is very useful when using other forms in between each shape you create.

☆ Draw Star

**Number of Points**

**Center Point**  
☆ X:  Y:

**Outer Radius**  
☆  inches

**Inner Radius Percentage**  
☆

To edit an existing shape  
hold shift while selecting

Create
Close

## Interactive - cursor

The quickest and easiest way to create a star is by clicking and dragging the shape to size in the 2D View using the mouse.

- Click and hold the left mouse button to indicate the center point.
- Drag the mouse while holding down the left mouse to required radius.
- Release the left mouse button to complete the shape.

**Note:** Holding Alt and dragging creates a star from the *middle* point.

As the cursor is dragged across the screen so the outer radius is dynamically updated. The increments will depend upon your snap radius and the job size.

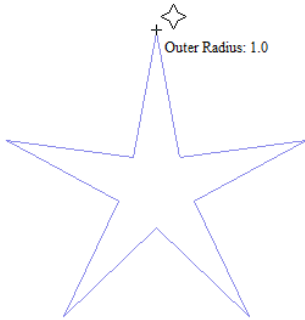

## Quick Keys

Instead of releasing the left mouse button when you have dragged your shape to the required size, you can also type exact values during the dragging process and set properties precisely.

- Left-click and drag out your shape in the 2D View.
- With the left mouse button still pressed, enter a quick key sequence detailed below.
- Release the left mouse button.

## Default

By default, entering a single value will be used to set the outer radius of your star. While you are dragging out the star, type **Radius Value** Enter to create a star with the precisely specified outer radius.

## Example

Quick Keys	Result
2 . 5 Enter	Creates a star with an outer radius of 2.5, all other settings as per the form.

## Specifying Further Properties

By using specific letter keys after your value, you can also indicate precisely which property it relates to.

**Note:** When specifying multiple properties with quick keys, it is still important that they are entered in the *order* indicated in the table below.

Quick Keys	Result
<b>Value</b> D	Creates a star with the outer <b>diameter</b> (D) specified, with all other properties as per the form.
<b>Value</b> I <b>Value</b> R	Creates a star with the <b>inner radius percentage</b> (I) and the outer radius (R). The inner radius is defined in terms of a percentage of the outer radius or diameter. All other properties are as per the form.
<b>Value</b> P <b>Value</b> R	Creates a star with the specified number of points (P) and the outer radius (R).
<b>Value</b> P <b>Value</b> I <b>Value</b> R	Creates a star with the specified number of points (P), inner radius percentage (I) and the outer radius (R).

**Note:** Diameter (D) values are interchangeable with radius (R) values in the combinations above.

## Examples

Quick Keys	Result
1 R	Outer radius (R) 1, other properties as per form.
1 D	Outer diameter (D) 1, other properties as per form.
6 P 1 R	An 6 pointed (P) star with an outer radius (R) of 1.
6 P 1 D	An 6 pointed (P) star with an outer diameter (D) of 1.
6 P 2 5 I 4 D	A 6 pointer (P) star with an outer diameter (D) of 4 and an inner diameter that is 25% of the outer (i.e. 1).

**Note:** These key combinations must be pressed whilst dragging with the mouse during shape creation.

## Exact Size

Stars can also be drawn by entering the Number of Points, Center Point, Outer Radius and Inner Radius Percentage.

- Click  to update the star.

## Edit

- Select the star to modify and open the **Draw Star** form.

The selected shape is displayed as a dotted **magenta** line.

- Edit the required parameters.
- Click  to update the star.

To modify another star without closing the form hold a **Shift** key down and select the next star.

## Close the form

To finish drawing with the tool, you can:

- Click  on the form
- Press the **ESC** key
- Click the Right mouse button in the 2D View.

## Draw Polyline



This tool creates continuous straight lines through points clicked, entered coordinates, tangent between a point and an arc or tangent to two arcs.

**Note:** Pressing the **Space-bar** re-opens the last vector creation form you used. This is very useful when using other forms in between each shape you create.

## Interactive - cursor

The quickest and easiest way to draw a line is by clicking within the 2D View using the mouse.

- Click the left mouse button to indicate the start point of your line.

**Create Line / Polyline**

**Next Point**

X:  Y:

Angle:  L:

dx:  dy:

---

**Cursor Position**

X:  Y:

Angle:  L:

dx:  dy:

Press the 'Space Bar' to finish the current line and start a new one. Right mouse click to finish line and exit form.

- Move the mouse pointer and click again to set the next point in your line.
- Repeat this process to add as many line segments as you require.
- Right-click or press `ESC` to finish your polyline *and exit* the form.
- **Alternatively** press the `Spacebar` to complete this polyline but *keep the form open* and begin drawing another polyline.

**Note:** Placing the mouse pointer close to the first point on the polyline and clicking will snap the polyline closed.

## Creating Tangent Lines

The polyline tool can also be used create lines that are tangent to arcs in your existing drawing.

### From A Point To An Arc

To create a line tangent from a point to an arc simply enter the initial point and then hover the cursor over the arc and press `T`.

### From An Arc To A Point

To create a line tangent from an arc to a point click on the arc to insert a point and then hover the cursor over the next point position and press `T`.



**Note:** You cannot create a tangent line to a bezier curve.

### From An Arc To Another Arc

To create a line tangent from one arc to another click on the arc to insert a point and then hover the cursor over the second arc and press `T`.



**Note:** Arcs are not trimmed as a result of creating a tangent line.

## Extending Contours

An existing open contour can be extended by holding down the `Ctrl` key and then clicking on either its start or end point.

**Note:** `Ctrl` clicking on the start point of a contour will cause the contour to be reversed before extending.

## Quick Keys

Instead of releasing the left mouse button when you have dragged your shape to the required size, you can also type exact values during the dragging process and set properties precisely.

- Left-click and drag out your shape in the 2D View.
- With the left mouse button still pressed, enter a quick key sequence detailed below.
- Release the left mouse button.

### Default

By default, entering a single value will be used to add a point at the specified distance along the line direction currently indicated by the mouse pointer position, relative to the preceding point. With polyline drawing underway, move the mouse pointer in the direction you wish to create a new line segment and type **Length Value** `Enter` to extend the line by the specified distance in that direction.

By default two values, separated by a comma, will create the next line point at the *absolute* X Y coordinate indicated by the two values, respectively. While drawing, type **X Value** , **Y Value** `Enter` to place the next point precisely at specified

X and Y position.

## Example

Keys	Result
3 . 5 Enter	Adds the next point at a distance of 3.5 along the line direction indicated by the current mouse pointer position.
1 , 2 . 5 Enter	Adds the next point at the absolute position 1 in X and 2.5 in Y

## Specifying Further Properties

By using specific letter keys after your values, you can also specify the line segment in terms of angle and length.

Quick Keys	Result
Value A Value L	Creates the next line segment at an angle (A) degrees from the last point and with a length (L).

**Note:** When specifying multiple properties with quick keys, it is still important that they are entered in the *order* indicated in the table above.

## Examples

Keys	Result
4 5 A 3 L	A line segment at 45 degrees (A) and a length (L) of 3.
1 5 A 2 . 5 L	A line segment at a 15 degree angle (A) and a length (L) of 2.5.

**Note:** These key combinations are pressed once you have begun using the mouse to draw your polyline.

## Next Point

You can also use the form to enter values for each line segment as you go along. The segments can be defined using:

- The absolute X Y position of the next point
- The Angle and Length to the next point
- The relative offset in X (dx) and Y (dy) to the next point.

Once you have entered the values you wish to use:

- Click the **Add** button to enter a new point.
- The **Undo** button deletes the last point entered and allows a new point to be added.
- The **Finish** button completes drawing the current line and leaves the form open to allow additional lines to be drawn.

**Note:** The X Y position use absolute coordinates.  
The Angle, Length and dx/dy positions are incremental from the current position.

## Create Arc



The **Create Arc** tool allows a single arc span to be created using precise values, or dynamically within the 2D View.

**Note:** Pressing the **Space-bar** re-opens the last vector creation form you used. This is very useful when using other forms in between each shape you create.

### Through 3 Points

- Left click the mouse in the 2D View to set the start point of an arc.
- Click again to set the end point position.
- Move the mouse and click a third point to set the arc's radius.

### Center, Start and End

**Create Arc**

**Create**

Through 3 Points

Center, Start and End

**Edit**

**Start Point**

X: 0.0 Y: 0.0

**End Point**

X: 0.0 Y: 0.0

Set Radius 0.0

Set Height 0.0

**Create** **Close**

- Left click the mouse in the 2D View to set the center point of the arc.
- Click again to set the start point of the arc.
- Move the mouse and click a third point to set the end point of the arc.

**Note:** Clicking the Right mouse button or pressing the `Esc` key will complete the arc drawing if possible and close the form.

## Exact Size

Precise values for the start and end point positions (in absolute X Y coordinates) and either the radius or the height of the arc can be entered in the form directly. Click `Create` to draw and arc using these values.

## Editing An Existing Arc

The properties of an arc can be edited at any time by selecting the arc before choosing the **Create Arc** tool.

This opens the form with the current properties and position of the selected arc and these values can then be edited.

Click `Apply` to update the selected arc with the new values.

## Draw Curve

### S

This tool creates a smooth, flowing, continuous curve through clicked points.

**Note:** Draw Curve does not require an associated form, just use the mouse cursor directly within the 2D View.

- Click in the 2D View to begin drawing at the clicked point.
- Move the mouse pointer within the 2D View and click the left button to insert as many points as you require. A curve will be created that smoothly joins your points.
- Click the right mouse button or press `Esc` to finish drawing your curve and *close the tool*.
- **Alternatively**, press `Space Bar` to finish drawing one curve, *but keep the tool active* so that you can immediately begin drawing another curve.

**Note:** Left clicking when the mouse pointer is close to the first point on the curve will snap the curve closed.

## Extending Contours

An existing open contour can be extended by holding down the `Ctrl` key and then clicking on either its start or end point.

**Note:** `Ctrl` clicking on the start point of a contour will cause the contour to be reversed before extending.

# Create Vector Texture



Repeating texture patterns can be created using the Create Vector Texture tool. These vectors can be machined in a variety of ways to create attractive textures.

To use the tool click the icon on the drawing tab. If required, select any contours that you wish the pattern to be created within. By using the sliders and edit boxes on the form the style of the created pattern can be varied. Click **Preview** to see a preview your created texture as you adjust the form's parameters. When you are happy with the preview, click **OK** to create the pattern.

**Note:** Pressing the **Space-bar** re-opens the last vector creation form you used. This is very useful when using other forms in between each vector texture you create.

## Angle

The lines in the texture are created at an angle. This value can be set to any value between -90 degrees and 90 degree.

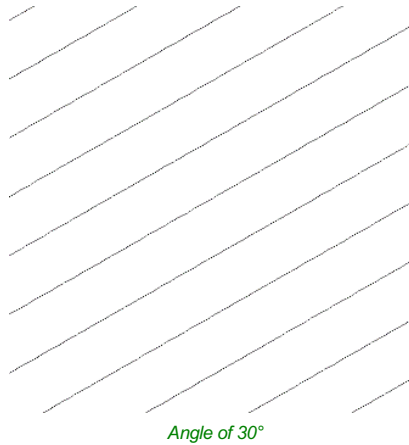

## Line Spacing

The line spacing controls the distance between the contours created by the tool. Use the edit box labeled Max. Spacing to enter a maximum value of line spacing. The slider underneath the edit box controls the degree of variation in the line spacing. If the slider is to the far left then this mean variation is at a minimum and so the lines are evenly spaced. If the slider is to the far right the variation is highest and so the distance between created contours varies between zero and the maximum spacing specified.



Minimum variation



Maximum Variation

## Wave Parameters

Within this section of the form the created pattern can be made to behave in a wave-like fashion. This wave is controlled by two parameters: the amplitude and wavelength.

## Wavelength

The wavelength describes the length over which the contours shape repeats itself. A bigger wavelength gives a long wave while a small wavelength gives a short wave.

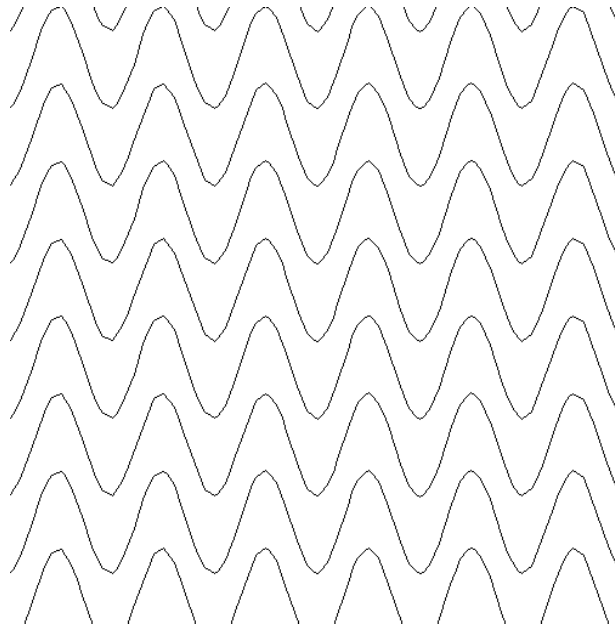

*Short wavelength*

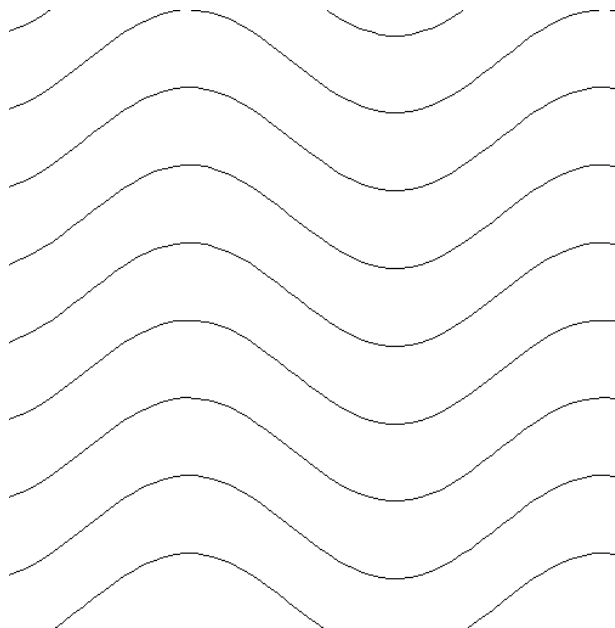

*Long wavelength*

## Amplitude

The amplitude describes the height of the wave. Larger amplitude means a taller wave and smaller amplitude means a shallow wave.

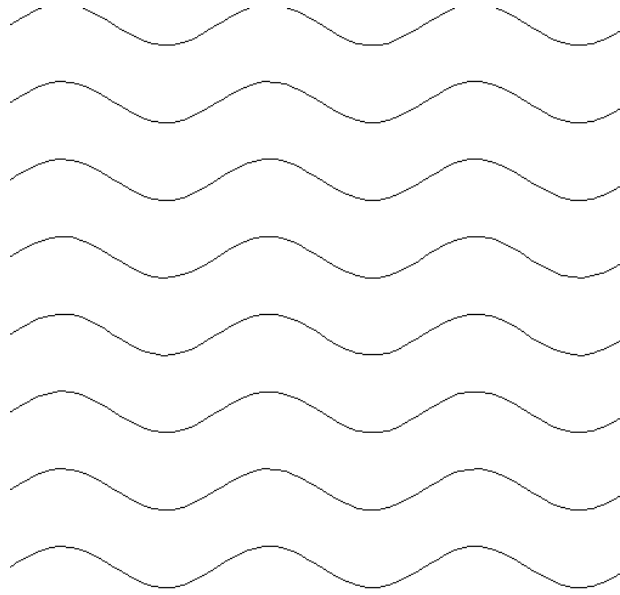

*Small amplitude*

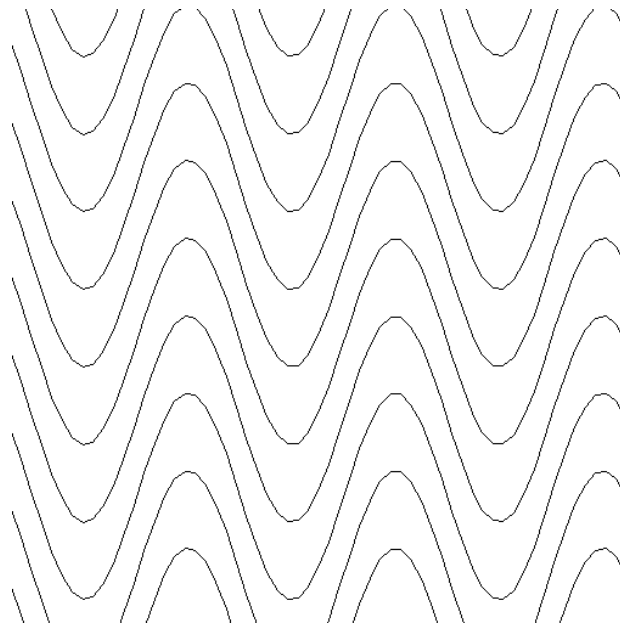

*Large Amplitude*

## Noise

The noise slider controls the degree of randomness applied to the above values and can be used to create less regular patterns.



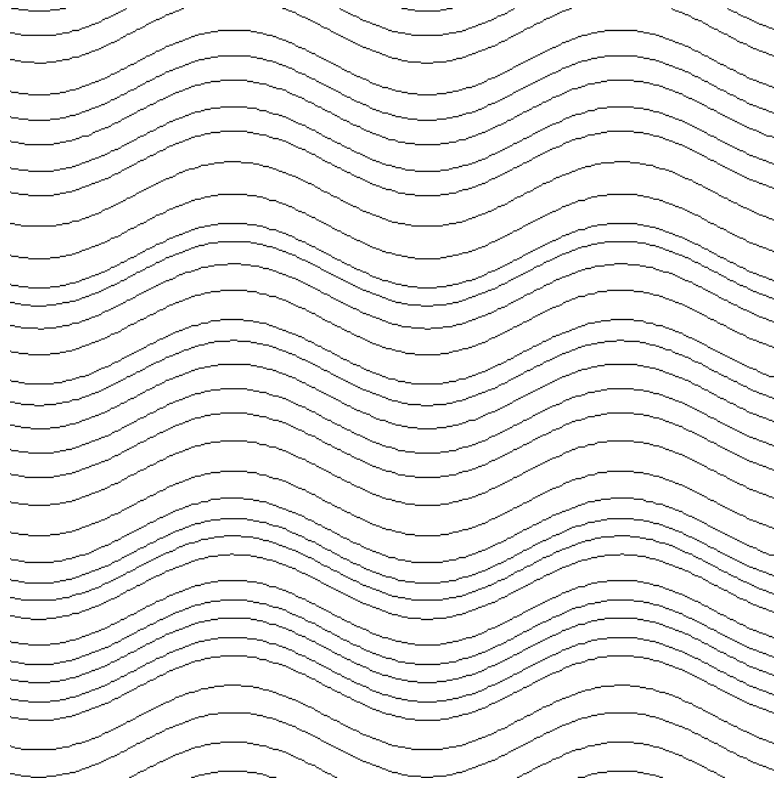

*No noise*

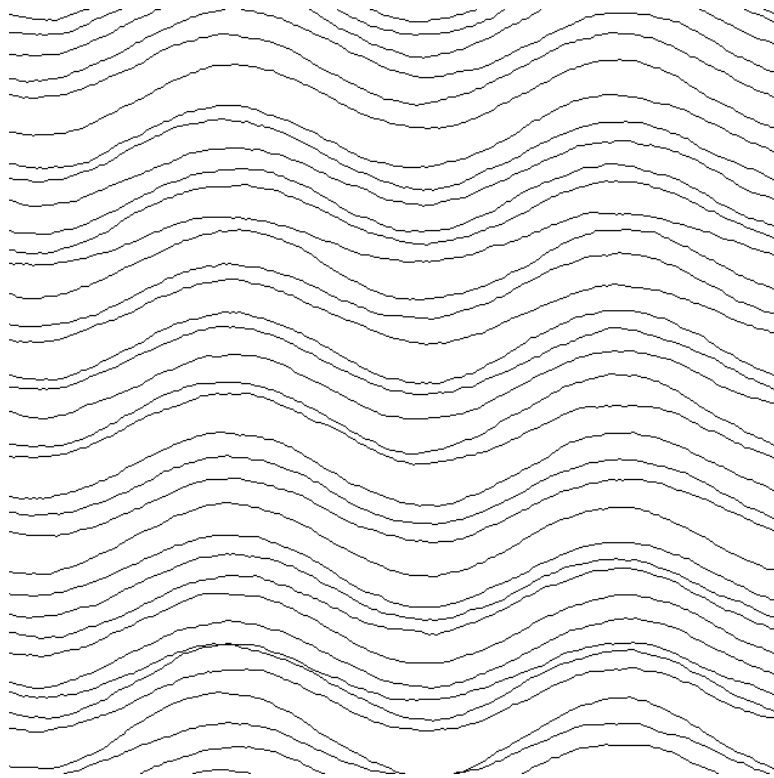

*Medium noise*

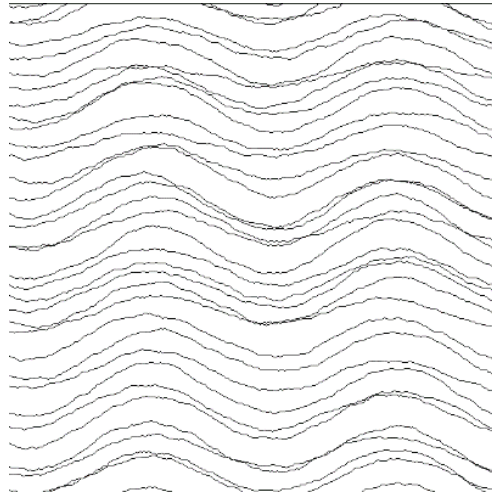

*High noise*

## Vector Layer

To create the vectors on a new layer make sure the check box labeled **Place Vectors on Layer** is checked ✓ and enter the layer name into the edit box labeled **Name**.

## Applications

The vectors created by this function have many applications but a key one is to combine them with either a Profile Toolpath or where available the Texture Toolpath to create decorative panels and background textures, a small selection of the possible results you can derive from this combination are shown in the images below.

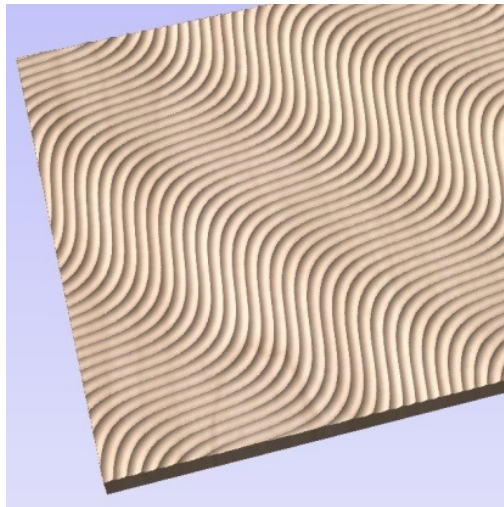

*Ball Nose Tool - Wave Pattern*

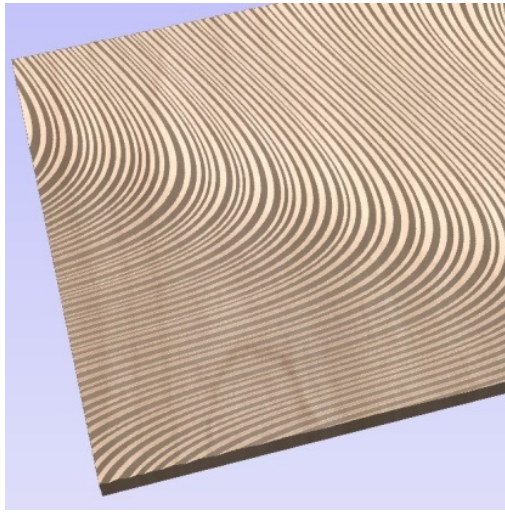

*V-Bit Tool - Swirl Pattern*

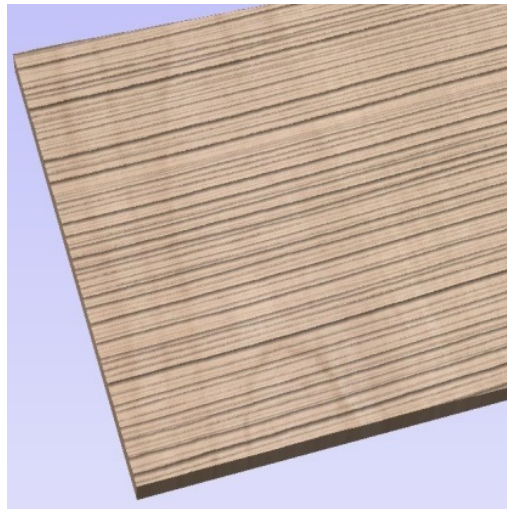

*Ball Nose Tool - Grain Pattern*

## Create Text

### T

This form allows text to be created at a specified point and height.

Text is edited in-place including Arc Text and Text on a Curve, even if it has been moved, scaled and rotated.

If the form is opened with no selection, the new text is placed somewhere on the material (if possible) between the center of the material and the center of the view to help keep it visible. An empty box is drawn in the view which helps visualize the currently specified text height and anchor point.



*Text height and position guide for empty text*

Existing text has guide lines showing the height of the top line of text. Some fonts will descend below the lower line like handwriting on a note pad.

Clicking selected text while editing, changes the anchor point to a box which can be dragged and dropped with snap.

The view is updated shortly after the user stops changing the form properties (e.g. mouse-wheel scrolling through the font list).

Changing the justification maintains the anchor point

Custom kerning and spacing (adjusted using the Kerning and Spacing tool) is maintained through the edit where possible.

#### See Also:

- The Auto Layout Text form (text in a box).

T Create Text

**Text**

Larger Edit ...

**Font**  TrueType  Single Line

T Times New Roman abcde /

**Bold**  *Italic*

**Text Alignment**

Left  Center  Right

Text Height:  inches

**Anchor**

X:  Y:

(Click on drawing to set position)

Close

- Arc Text.
- The Text On A Curve form.
- Kerning and Spacing.
- Convert Text To Curves.

**Note:** Pressing the Space-bar re-opens the last vector creation form you used. This is very useful when using other forms in between each bit of text you create.

## Vertical Fonts

Fonts that start with the @ character are drawn vertically downwards and are always left justified.



## Engraving Fonts

The Single Line Radio Button changes the Fonts list to show a selection of fonts that are very quick to engrave.

## Options

The Larger Edit... button opens a larger text entry window that makes it easier to enter text that needs to run on longer line lengths. Clicking OK accepts any text entered into the window and Cancel will throw away any changes.

## Text Alignment

Positions text relative to the full body of text, this only has a noticeable effect when writing multiple lines of text.

## Anchor

Sets the position of your text block. Either enter values directly and click Apply, or click in the 2D View with the mouse cursor to set the position values interactively. Clicking in the 2D View will begin a new block of text, set to the new Anchor point.

## Edit Text

To edit text properties or content of previously created text:

If the Create Text form is open, hold the Shift key down and click the text you wish to edit or

If the Create Text form is closed, click the left mouse button on the text in the 2D View to select it before opening this form. The form will now allow you to edit the properties of the selected text.

Click the Apply button to update the changes in the 2D View. Click the Cancel button to finish or cancel the editing and close the form.

## Auto Layout Text



This option automatically sizes a block of text to fit inside the bounding box (width and height limits) of a selected vector. If no vector is selected the text is scaled to fit the size of the material.

**Note:** Pressing the Space-bar re-opens the last vector creation form you used. This is very useful when using other forms in between each bit of text you create.

When the Text form is open, the Dimensions for the Width and Height of the selected vectors or job dimensions are shown, and these are used to constrain the font size of the text.

### See Also:

- The Create Text form.
- Arc Text.
- The Text On A Curve form.
- Kerning and Spacing.
- Convert Text To Curves.

## Entering Text

The procedure for Drawing Text in the 2D Window is:

- Select the vector inside which the text is to be fitted
- Click the Draw Text icon
- Enter the required text content
- Select the font either True Type or Single Line as required and alignment options
- Click

## Vertical Fonts

Fonts that start with the @ character are drawn vertically downwards and are always left justified.

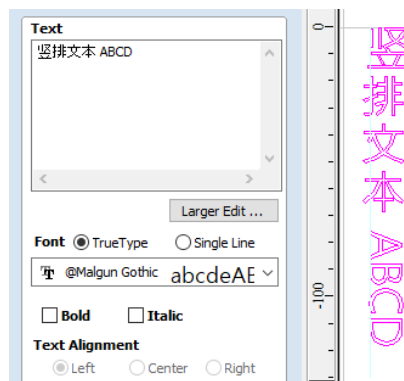

Vertical Text

## Engraving Fonts

The Single Line Radio Button changes the Fonts list to show a selection of fonts that are very quick to engrave.

This example shows text (in an Engraving Font) drawn in an ellipse. The bounding box of the ellipse is used for the layout:

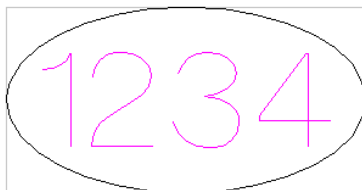

**Note:** If no vector(s) are selected to define the bounding box, the text is sized to the material and positioned centrally

## Options

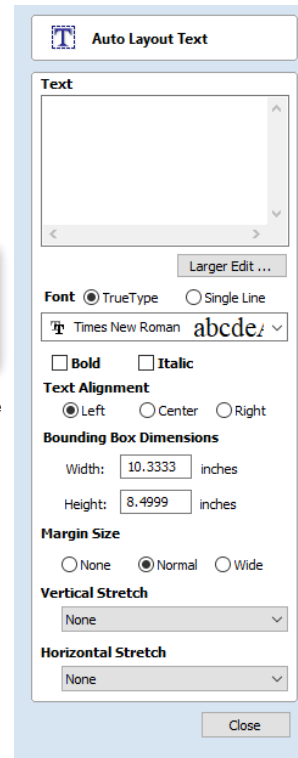

The **Larger Edit...** button opens a larger text entry window that makes it easier to enter text that needs to run on longer line lengths.

Clicking **OK** accepts any text entered into the window and **Cancel** will throw away any changes.

## Text Alignment

Positions text relative to the selected bounding box or material size with options for left, center and right aligned.

## Bounding Box Dimensions

These are the actual size of the box into which the text will be fitted. If the text is scaled interactively (by left clicking twice on the text) or precisely using the scale tool, the new bounding box is updated and displayed as a light gray rectangle.

## Margin Size

The distance between the text and the bounding box where:

- **None** - Scales text to fit the rectangle width or height of the bounding box
- **Normal** - Scales text to fit within 80% of the bounding leaving a 10% border to the left and right.
- **Wide** - Reduces the size to 60% of the rectangle width leaving a 20% border to the left and right.

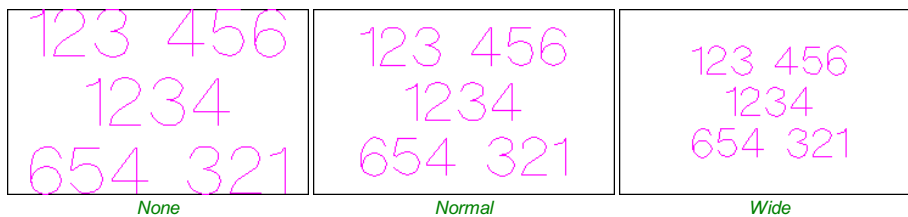

**Note:** The font size is automatically scaled to give the selected margin size.

## Vertical Stretch

When the text fits the width of the box and there is space above and below it, the text can be made to fill that vertical space using one of these methods:

**Note:** Vertical Stretch will have no effect when the text already fits the box vertically!

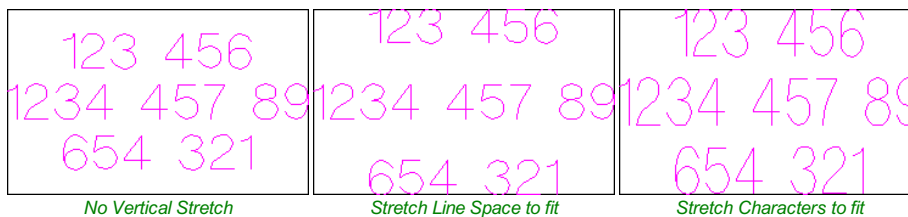

## Horizontal Stretch

When the text fits the height of the box and there is space at the sides, the text can be made to fill that horizontal space using one of these methods:

**Note:** Horizontal Stretch will have no effect when the text already fits the box horizontally!

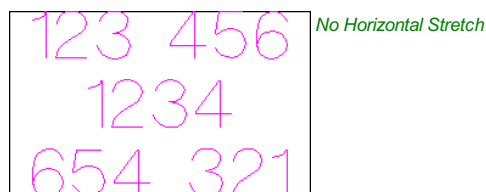

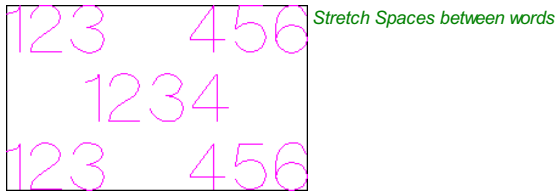

Stretch Spaces between words

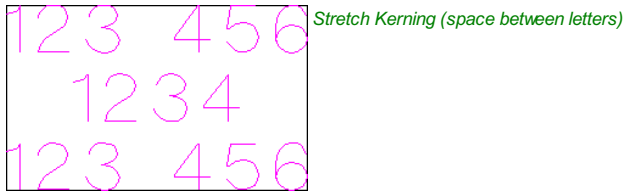

Stretch Kerning (space between letters)

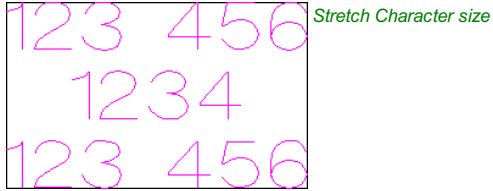

Stretch Character size

## Edit Text

To edit text properties or content of previously created text:

If the Create Text form is open, hold the **Shift** key down and click the text you wish to edit or

If the Create Text form is closed, click the left mouse button on the text in the 2D View to select it before opening this form.

The form will now allow you to edit the properties of the selected text.

Click the **Apply** button to update the changes in the 2D View. Click the **Cancel** button to finish or cancel the editing and close the form.

## Text Selection

### Interactive Letter kerning and Line Spacing



Select the cursor and click to select the Text to be edited. The text will be displayed as magenta lines with 2 Green handles in the middle for dragging the text into arc-text:



### Letter Kerning

The interactive kerning and line spacing cursor is shown when placed between letters or lines:



The interactive letter kerning allows default text to be modified so that adjacent pairs of letters sit more naturally together. A typical example is shown above where the capital letters W A V are placed next to each other and the default space is excessive.

Place the cursor between 2 letters and click the Left mouse button to close the gap.

Holding a **Shift** key and clicking the Left mouse button moves the characters apart.

Holding a **Ctrl** key when kerning doubles the distance each letter moves on each click.

Holding **Shift** and **Ctrl** keys together and clicking the Left mouse button moves the letters closer together in larger increments.



The gap between the 1 and 2 has been reduced.

## Line Spacing



Line spacing can be modified by placing the Edit Text cursor between lines. It will change to the line spacing cursor:



Clicking Left mouse button will move the adjacent lines of text closer together.

Holding the `Shift` key and clicking the Left mouse button will move the lines apart.

Holding the `Ctrl` key doubles the distance each line moves on each mouse click.

Holding the `Shift` and `Ctrl` keys together and clicking the Left mouse button moves the lines apart in larger increments.

## Text Arcing



The interactive rotation and movement cursor is displayed when the cursor is placed over either of the Green Handles to indicate that the text can be arced either Upwards or Downwards:



Click and Drag the Bottom Green box to arc the text Downwards.

Click and Drag the Top Green box to arc the text Upwards.

The text can easily be dragged back into the horizontal position again.

After arcing text, additional Red and Blue handles are displayed for Rotating and Moving the text.

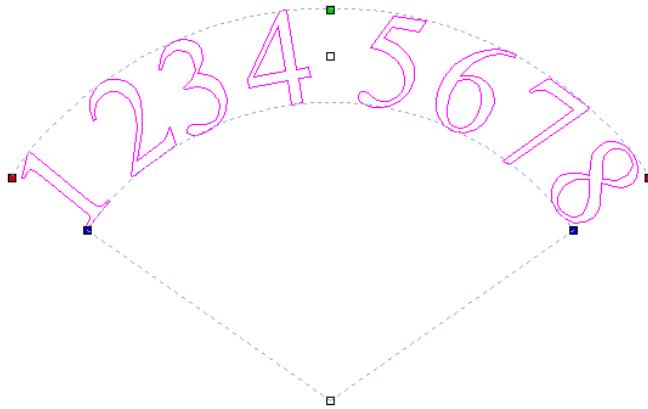

Clicking and dragging the Red boxes rotates the text around the center point of the arc.

Holding the `Ctrl` key forces the rotation to be in  $15^\circ$  increments. This allows the text to be positioned exactly on the horizontal or vertical quadrants, even after it may have been moved slightly.

Clicking and dragging the Blue boxes changes the radius without moving the arc center.

There are two handles for moving the text, one in the middle of the text, and one in the center of the arc, though that may be off-screen for very shallow arcs:

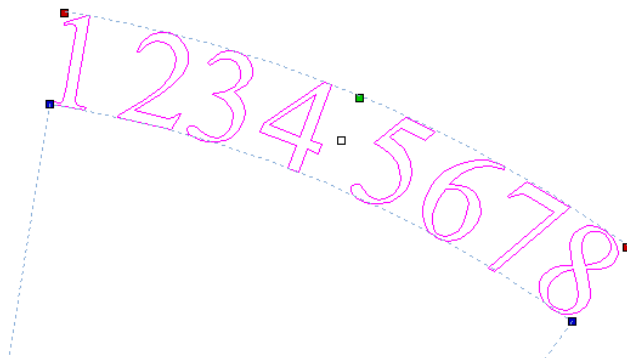



**See Also:**

- The Create Text form.
- The Auto Layout Text form (text in a box).
- The Text On A Curve form.
- Kerning and Spacing.
- Convert Text To Curves.

## Convert text to Curves



In most cases all Text created in Cut2D Desktop can be VCarved, Engraved, Pocketed and Profile machined or used with the 3D modeling functions. Some fonts do occasionally include loops and problems that need fixing using the Node Editing tools before it can be utilized for other functions. This text first has to be converted to Curves, creating lines, arcs and Bezier spans that can be interactively edited to fix the problem areas.

**See Also:**

- The Create Text form.
- The Auto Layout Text form (text in a box).
- Arc Text.
- The Text On A Curve form.
- Kerning and Spacing.

Script style fonts that are based on overlapping characters can be VCarved or Engraved without having to first convert the characters to curves.

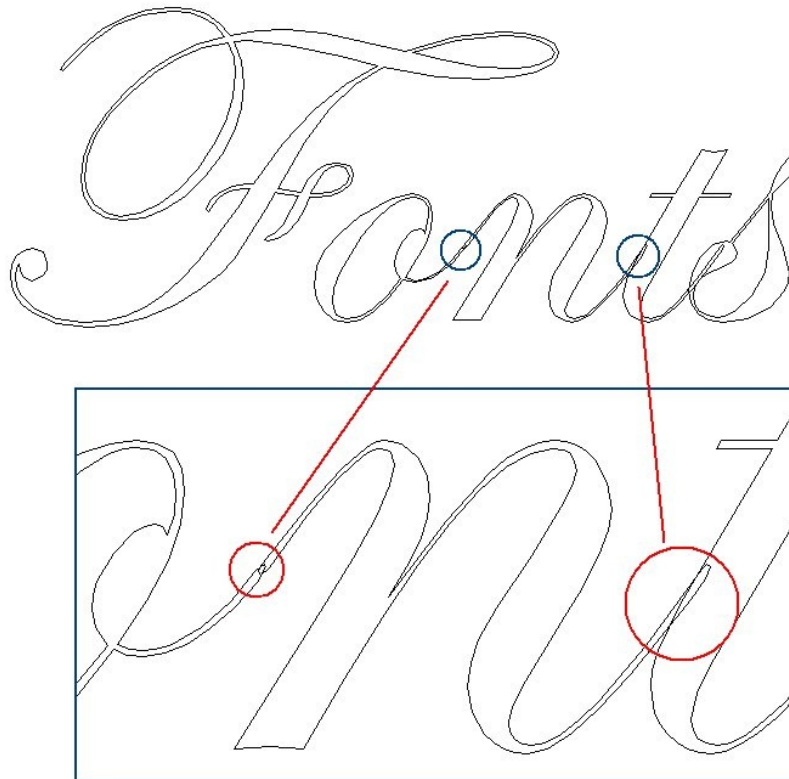

If the individual characters contain overlapping vectors or loops these will need fixing manually using the Node editing tools.

**Note:** The Vector Validator may be useful to use to locate the overlapping vectors in Script Fonts.

When Profile Machining with Tabs is required the text must first be converted to curves. Opening the Tab form on the Profile machining form will show a message stating that the text must first be converted to curves and clicking the  button will automatically make the conversion.

Text can be converted to curves at any time by selecting the icon or clicking the Right mouse button and selecting Convert Text to Curves.

**Note:** After converting text to curves it cannot be edited as a text block.

# Text on Curve



This tool requires the user to select a single line of text with the Draw Text tool and a single vector curve/line. It will take the text and fit it onto the selected vector to follow the curvature. Options within the tool allow position, space and location against the line to be edited.

The Create Text Form can be used to edit the text on the curve (even if the curve has been deleted).

### See Also:

- The Create Text form.
- The Auto Layout Text form (text in a box).
- Arc Text.
- Kerning and Spacing.
- Convert Text To Curves.

**Note:** Pressing the Space-bar re-opens the last vector creation form you used. This is very useful when using other forms in between each bit of text you create.

## Text Size

### Maintain text Size

Will not change the size of the text block



### Scale text to fill curve

Will increase the character size in order to fit along the entire length of the selected curve.



## Text Spacing

The slider can be used to increase or decrease the word and character spacing. Each time the form is opened, or new text is selected, this control starts at the 100% mark. While this text is being edited the spacing scale can be increased or decreased from its original value.

## Text Position

The position of text relative to the curve is calculated using the height of the largest letter in the selected text string.

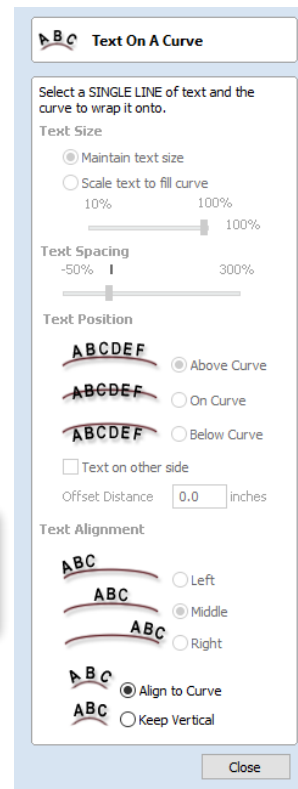
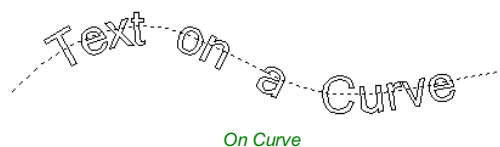
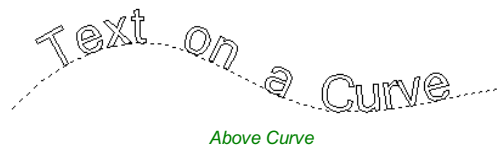

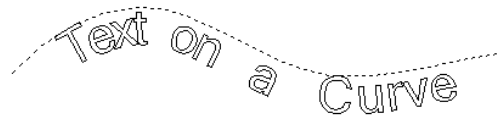

*Below Curve*



*Text on other side*

### Offset Distance

Allows the text to be moved away from the curve by a specified distance.

### Text Alignment

The 3 options allow the text fitted to the curve to be aligned to the left, middle or right hand side of the selected curve. Or, when using a closed vector curve, relative to the Start Node.

**Note:** Remember the Start node can be changed using the Node Editing Tools available from the Right mouse menu and selecting Reverse Direction.

Characters in the text string can also be aligned 'normal' to the drive curve or left in the original vertical position.



*Align to Curve*



*Keep Vertical*

# Trace Bitmap



This tool automatically traces or fits vectors to image files so they can be machined. Use the Import Bitmap tool and select the image in the 2D view, then open Fit Vectors to Bitmap.

After importing an image the Tracing option allows vector boundaries to be created automatically around colored or black and white regions in the image.

**Note:** Pressing the Space-bar re-opens the last vector creation form you used. This is very useful when using other forms in between each bitmap you trace.

## Tracing a Selected Area of the Bitmap

You can define an area within the bitmap, such that only that part of the bitmap will be traced. This can be done by selecting the bitmap (if this hasn't been done already), and then clicking and dragging the mouse over the area you want, to define a rectangular region on the bitmap. This will be highlighted with a dashed black rectangle.

Clicking on the Bitmap again will remove a selected area if one has been specified, in which case, the entire bitmap will have vectors fitted to it.

Images can be traced either in color or black and white mode and the basic process is described below:

If the image is black and white already, the process can be considerably simplified by selecting the Black/White option.

For color images you can also reduce the number of colors you need to work with by using the slider to further simplify the trace selection process.

Check  the boxes next to each color swatch to link colors to the Trace Color. These are the colors that will be included in the area to trace.

Adjust the fitting parameters for the resulting vector and use the **Preview** button to trace.

Click the **Apply** button when you are happy with the preview.

After vector fitting you will often need to adjust the vectors so be sure to watch the video tutorials on vector editing available for the software.

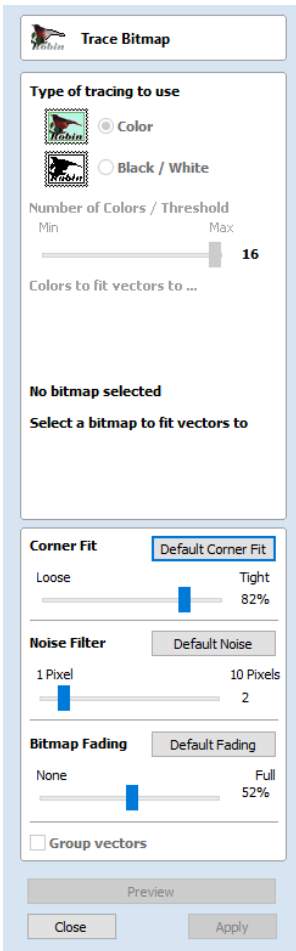

## Working with Color Images

Color images are automatically reduced to 16 colors and the slider allows the visible number of colors to be set as required. Colors are merged with the closest match.

Colors can be temporarily linked together by clicking the check boxes next to each of the colors displayed. This changes the color displayed in the 2D view to the selected Trace Color. This is very useful for merging similar color's together to allow complete regions to be traced.

If a new Trace Color is selected the linked colors are displayed using this color in the 2D view.

The Reset button unlinks all the checked  colors and the image displayed in the 2D view reverts back to the original 16 color image.

## Working with Black and White Images

When working with Black and White images the slider can be used to change the Threshold and merge the levels of gray between all white (min), and all black (max).

When the image being displayed in the 2D view looks correct then clicking the **Preview** button automatically creates vector boundaries either around the selected Trace Color or the grayscale.

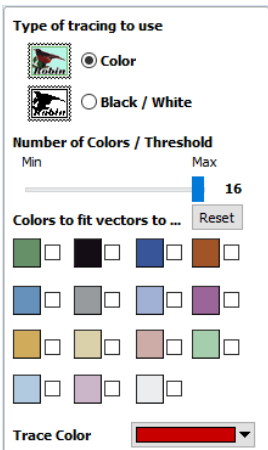

## Fitting-Options

The options available on this form control how closely the vectors fit / follow the selected color boundaries and these can be modified to obtain improved results.

### Corner Fit

The Corner Fit control determines how accurately the vectors are fitted to the corner edges in an image.

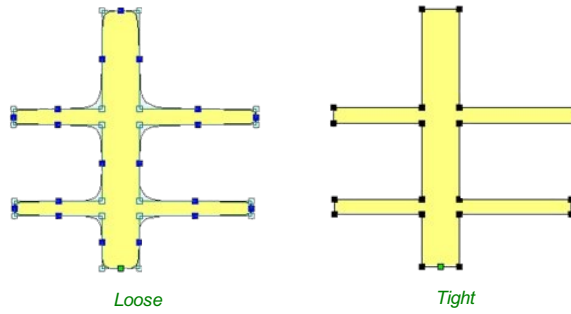

## Loose

Loose will create smooth curves that may not follow corners very precisely, but will create smooth free-flowing vector boundaries, with few nodes.

## Tight

Tight inserts nodes to ensure the vector accurately follows the color boundary, to create sharp detail.

When using the Trace Color option it's sometimes useful to link a region of color's together, fit vectors and then link a new region or color's together, un-check the replace existing vectors option and fit another set of vector boundaries.

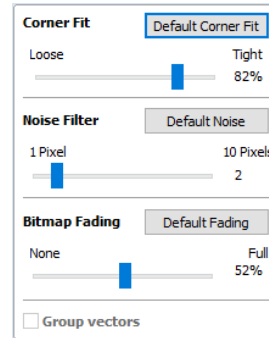

## Noise Filter

The Noise Filter slider controls the minimum size of pixels that are traced / vectorized, preventing small unwanted vectors or noise being created.

For example, if an image contains single or very small clusters of pixels that aren't needed for machining a design. Then using the noise filter slider set at 4 pixels will ignore 2 x 2 or smaller pixel clusters.

**Note:** It's often useful for the vectors to be created on a different layer to the Bitmap layer. Therefore, remember to select a different layer before creating any vectors.

## Bitmap Fading

The Bitmap Fading slider controls the shading of the image in the 2D View. This is useful to see the trace vectors more clearly over high-contrast images.

## Preview

This will preview the result of the tracing of the bitmap. If you are not happy with the result provided, you can alter the settings and click on the  button again to get an updated result.

## Apply

When you are happy with the result of the preview you can click on the  button to keep it.

## Close

Closes the Trace Bitmap form.

**Note:** The Vector Validator may be useful to use after tracing a bitmap to locate any possible overlapping or intersecting vectors that may need editing before embarking on any shape or toolpath creation.

# Dimensions



This tool allows you to add a variety of dimensioning annotations to your vector drawing.

**Note:** Pressing the **Space-bar** re-opens the last vector creation form you used. This is very useful when using the Editing forms in between creating dimensions.

Unless specified separately below, the dimensions are created using these steps:

1. Select the dimension type you wish to need: length; height; width; angle or the radius or diameter of an arc.
2. In the 2D View, click with the left mouse button to set the points the dimension needs:  
For an Angle Dimension, the first point is the centre-point.
3. Click where you need the arrow-tips to be.
4. Click to set the location of the dimension-line.
5. Click to set where the annotation text will appear.

**Note:** To undo that last click, press the **ESC** key.

- While dragging out a new dimension, a preview rectangle indicating the text size and position will be drawn.
- If you select a dimension before opening the Dimensions Form, the font properties can now be edited. Changing dimension-type or clicking a point on the screen while the form is open will start the creation of a new dimension.
- To edit an existing dimension while the form is open, hold down a **Shift** key while selecting it - there is a note on the form to remind you of this.
- When creating Dimensions, the mouse snaps onto vectors, guide lines and the four corners / mid-points around the edge of the job setup area unless a **Shift** key is held down while dragging.

? **Dimensions**

**Length Dimension**

**Vertical Dimension**

**Horizontal Dimension**

**Angle Dimension**

**Arc Dimension**

Show Diameter

Font  TrueType  Single Line

Times New Roman abcdefg

Text Height:  inches

Decimal Places:

Offset:  inches

Use Custom Text

Text:

Place dimensions on layer

Name:

To edit an existing dimension hold shift while selecting

Close

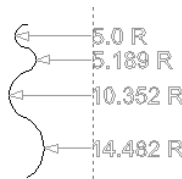

*Arc Dimensions snapped to a guide line*

## Length Dimension

Use this to dimension a straight-line length in any orientation between two points.

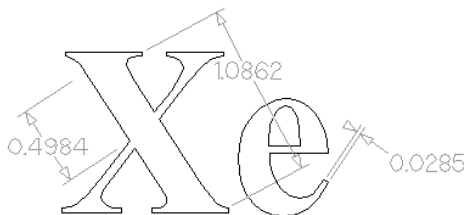

The text preview box will snap to to the middle of the dimension line, unless a **Shift** key is held down while dragging.

## Vertical / Horizontal Dimension

These two options also allow any two points to be selected, but the resulting dimension will be locked to indicate a vertical or horizontal distance (respectively) between the two points.

The text preview box will snap to to the middle of the dimension line, unless a **Shift** key is held down while dragging.

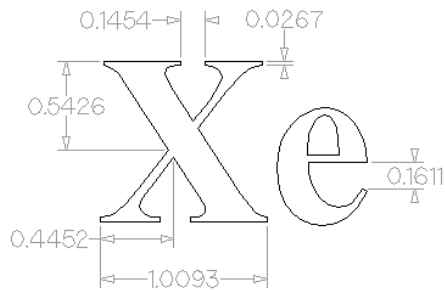

## Angle Dimension

This option allows any arbitrary angle to be measured. The process is similar to creating a 3 point arc. First you must pick the center of an angle you wish to measure - typically a corner point. The next 2 points clicked will set the extents of the sweep you are measuring. The next Click will determine the dashed dimension line positioning and the final click will set the position of the text annotation.

- Angle Dimensions' arrow-heads will pop outside small angles if there is not room to draw them inside.
- Angles are extended with a dashed extension-line where required, allowing the dimension to be placed anywhere. The text snaps to the angle center and the leader-line angle snaps to horizontal, vertical or diagonal (disable snapping by holding down a **Shift** key).
- Angle Dimensions use a separate **Decimal Places** value to the other dimensions (as you change dimension-type you may notice the **Decimal Places** value change).
- Angle dimensions can now have up to six decimal places.

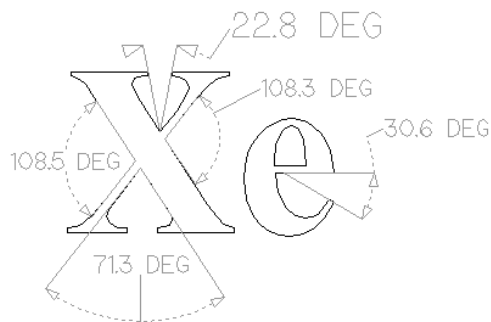

## Arc Dimension

With this option selected you will only be able to select arc spans with the first click of dimension tool (Bezier curve spans are not supported). The second click will set the position of the dimension annotation, which will show the radius (or diameter) of the selected arc span.

- To display the diameter of an arc dimension simply check  the **Show Diameter** box.
- Arc Dimensions recognise when a circle has been selected and allow placement anywhere around the circle. Arcs will now be extended with a dashed extension-line where required, allowing the dimension to be placed anywhere. The text snaps to the arc/circle center and the leader-line angle snaps to horizontal, vertical or diagonal (disable snapping by holding down a **Shift** key).

### Note:

Circles or arcs that are polygonized (from an imported file or from the **Curve fit vectors** command using **Straight lines**) are not recognized and cannot be dimensioned with this tool (which is in line with snapping which also won't work on polylines to see if they are circular). Circular Polylines can sometimes be dimensioned using the length dimensioning tools across their diameter.

The  **Fit Curves to Vectors** command may be useful to turn polylines or bezier curves into arcs.

The text in the following example was first converted to vectors using the **Convert Text to Curves** command, then those vectors were converted to arcs using the  **Fit Curves to Vectors** command:

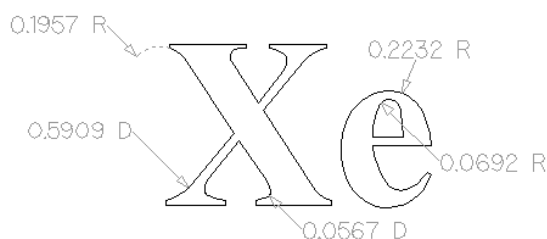

Further Angle Dimension Examples:

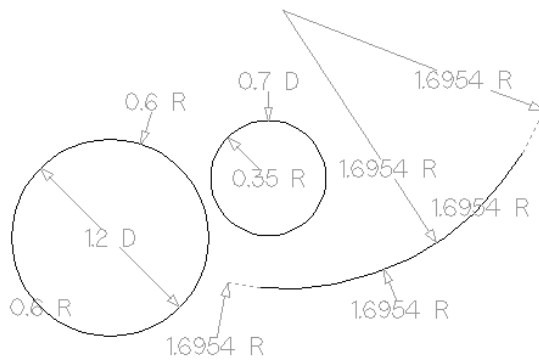

## Font Selection and Settings

This section of the form allows the user to change the settings for the dimension annotation, such as the font to be used, the height of the text and how many decimal places are required. The **Offset** field determines the gap left between the dimension markers and the vectors that are being measured.

## Use Custom Text

You can check  **Use Custom Text** to insert your own custom text. The text is stored per dimension, so you change between calculated and custom text without losing a dimension's custom text. When the form is first opened it defaults to calculated text.

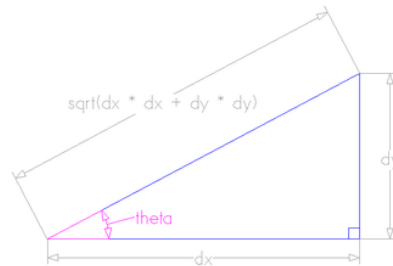

## Place Dimensions on Layer

By default this option is checked  and the dimensions will be placed on a mid-gray *Dimensions* Layer. You can edit the name of the layer in the **Name** edit field. If a layer of this name does not exist, it will be created automatically.

**Note:** Dimensions can be edited. Hold `shift` while selecting the dimension you wish to edit or use the **Undo** shortcut `Ctrl + Z` to undo previously created Dimensions while still in the Dimensioning tool.

The base of extension lines and the tips of arrows are snap-points allowing you to keep neighbouring linear dimension lines, lined up, for example.



# Transform Objects

## Transform Objects



The **Transform Objects** section contains all the icons which relate to commands for moving, sizing and manipulating objects.

## Quick Keys

This reduces the time to create accurate geometry by allowing typed values while creating geometry. This is supported for creation of circles, ellipses, rectangles, polygons, stars, polylines and when in editing nodes or transforming vectors.

For example, while dragging to create a circle, typing  $3 \text{ R}$  will create a circle with a radius of 3.

## Inputting a Value

Input mechanism is as follows:

1. Input the value first, and **Enter** to execute the default action (if applicable)
2. Input the value first, and then a letter indicating the type of action required.
3. Input 2 values separated by a comma, and **Enter** to execute a specified action (usually width and height or X and Y).

Input format is as follows:

1. Some actions require several input values.
2. In that case, it will be **value letter value letter**
3. The action will be performed automatically once all letters required for that action have been entered.

You can enter a value and press **Enter** which will perform the default action.

The input times out after 5 seconds, if nothing was entered.

The value could be a simple expression, similar to that used from some of our text fields.

A full list of shortcuts can be found on the [Shortcuts](#) page

## Move Selection



Selected items can be accurately moved and positioned using this option.

### Anchor

The anchor position determines the point on your selected object's bounding box that will be moved to the absolute position entered.

**Move Selection**

**Anchor**

**Type of Move**

Absolute  Relative

**X Position** 6.1667 inches

**Y Position** 5.25 inches

Apply Close

### Type of Move

#### Absolute

In this mode, the **X Position** and **Y Position** values will be used to position the object's anchor point directly.

#### Relative

With this option selected, the values entered in the **X Position** and **Y Position** fields will incrementally offset the object from its current position, by the distances entered. The **Anchor** options are not relevant in this mode and so will be disabled.

The keyboard shortcut **M** opens the **Move** form in interactive mode.

### Move Interactive



The default mode is to enable selected objects to be moved interactively by clicking and dragging with the cursor.

Holding down the **Alt** key when dragging objects around will constrain the movement to either the X or Y axes.

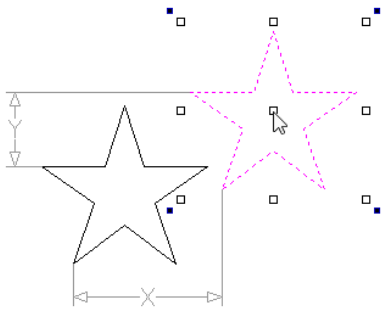

Pressing **Esc** or clicking **Close** will close the form.

**Notes:** Pressing **F9** at any time with an object selected will instantly move the selected object, centering it exactly in the middle of your material.

A full list of Keyboard and Mouse shortcuts can be found on the [Shortcuts](#) page.

## Quick Keys

For moving objects with a specific amount without having to go into the form, the Quick Keys can be used while dragging the object. Simply, activate interactive movement by clicking twice on the object, and then drag it and start typing the value as per the shortcut keys table. Then, either press **Enter** or the letter required to perform your action.

See Quick Keys shortcut table for a list of available actions.

## Smart Snapping

To constrain the movement of the object in the X or Y axis, start dragging the object along that axis and a snap line will appear that represent that axis.

This can be used in combination with the Quick Keys, mentioned above, to move the object by a set amount in a specific direction.

## Set Size



Selected items in the 2D View can be accurately scaled or resized using this option.

### Anchor

The anchor position determines the point on your selected object's bounding box that will be resized to the dimensions entered.

### Link XY

Checking  this option will always scale the height and width in proportion. Leaving the Link option unchecked allows non-proportional scaling

## Auto Scale Z

This option sets a specific mode of scaling for 3D Components. When it's checked,  scaling a model component in X or Y will result in it also scaling proportionately in Z, as such if you increase its size in X and/or Y then its Z Height will also increase and conversely when you reduce its X and/or Y size it will shrink in height. When it is unchecked then the Z Height of your Components will remain constant regardless of any X and/or Y scaling done either within this form or dynamically using the mouse in the 2D or 3D View.

## Size Interactive



The default mode is to enable selected items to be scaled interactively by clicking twice with the mouse.

The process is:

1. Select the vectors
2. Click a second time to activate the interactive options - handles on the selection box
3. Click and drag on the white handles

The keyboard shortcut **T** opens the **Scale** form in interactive mode.

## Interactive Handles

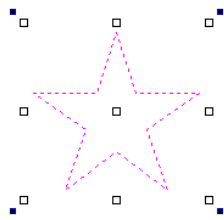

Handle	Operation	Additional options
White Corner boxes	Scaling proportionally	Hold <b>Shift</b> for scale <b>from middle</b>
White Center box	Move the selected objects	Hold <b>Shift</b> for <b>linear</b> X or Y moves
White Middle Side boxes	Scaling non-proportionally	Hold <b>Shift</b> for <b>symmetrical</b> scale
Blue Corner boxes	Rotating dynamically	Hold <b>Shift</b> <b>15° increments</b>

## Quick Keys

For scaling objects with a specific amount without having to go into the form, the Quick Keys can be used while dragging one of the scaling handles around the object.

Dragging an edge handle, a single value is expected to determine the amount of change in that direction. This can be a relative value or an absolute value.

Dragging a corner handle, two values are expected with the new width and height of the object. Alternatively, a single value followed by **S** to scale relatively.

See Quick Keys shortcut table for a list of available actions.

## Rotate



For precise control of the rotation, or to use a point other than the selection's center as the rotation center, you can open the rotation form from the Drawing Tab.

**Note:** The keyboard shortcut **R** opens the full **Rotate** form, including access to the moveable rotation **Pivot Point**. Clicking the selection twice begins interactive transform, which provides the rotation handles but without the advanced options of the Rotate form or access to the **Pivot Point**.

Selected items in the 2D View can be rotated to a new orientation using this tool.

The rotation options form can be activated from the tool icon on the Drawing Tab.

Alternatively you can use the interactive transform mode (where the form is not required) directly from the 2D View.

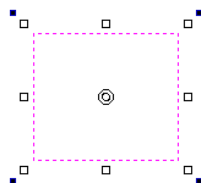

With this form open the additional **Pivot Point** handle is available (two concentric circles initially positioned at the center of your selection) for you to click and drag in the 2D View. The **Pivot Point** (around which the selection will be rotated) responds to the currently enabled snapping options to help you to position it precisely on significant locations within your artwork. Hold down the **Shift** key to temporarily disable snapping while you drag the **Pivot Point**.

## Pivot Point

On the form there are also six radio button options for snapping the rotation **Pivot Point** to the selection itself or to a precise position. The first five options allow you to snap to the corners and center of your selection.

## Use Coordinates

This sixth option allows you to precisely specify the position of the **Pivot Point** using the X and Y edit boxes. This is also the option that will be selected by default if you drag the pivot point using your mouse directly in the 2D View.

## Angle

The Angle edit box allows you to specify a precise rotation angle to apply to your selection. Click the **Apply** button to rotate your selection by the value in this box.

**Note:**  
A *positive* angle results in a *counterclockwise* rotation

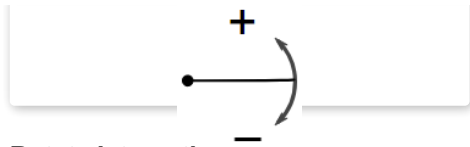

## Rotate Interactive

A *negative* angle results in a *clockwise* rotation



Generally the most convenient way to rotate an object in the 2D View is to use **interactive transform**. This mode is initiated by clicking the selected object twice with the cursor. The process is:

1. Select the object by clicking on it in the 2D View (or multiply select objects using box selection or by shift-clicking on them).
2. Click the selection a second time to activate the interactive options rotation handles on the selection box.
3. Click and drag on the blue handles (solid squares) at the far corners of the selection to rotate it.

**Note:** You can rotate the selection by a number of degrees during the interactive transform mode by typing in a value followed by the letter **R** while your left mouse key is still pressed. This will rotate your object by **R** degrees counterclockwise e.g. **45 R** will rotate your object 45° counterclockwise

**Note:** Holding down an **Alt** key when dragging to rotate the object snaps to angular rotation steps of 15° increments, this incremental value can be edited in the Snap Setting dialog (F4).

## Quick Keys

For rotating objects with a specific amount without having to go into the form, the Quick Keys can be used while dragging one of the rotation handles around the object.

See Quick Keys shortcut table for a list of available actions.

## Mirror



Selected vectors/bitmaps/component grayscale previews can be mirrored to a new orientation.

Selected objects can also be mirrored about axes of symmetry relative to the bounding box of the selection, using the standard options on the Mirror Form.

- Select the object or objects to mirror.
- Click on the Mirror icon to open the Mirror Form.
- Select the Create a mirrored copy option to leave the selection and create a new set of objects.
- Click the **Close** button to accept the changes.

## Shortcuts

The Shortcut Keys page describes these and other shortcuts that are used in Cut2D Desktop.

Shortcut key	Description
H	Mirror <b>Horizontally</b>
Ctrl + H	Create Mirror <b>Copy Horizontally</b>
Shift + H	Mirror <b>Horizontally</b> , around <b>center</b> of material
Ctrl + Shift + H	Create Mirror <b>Copy Horizontally</b> , around <b>center</b> of material
V	Mirror <b>Vertically</b>
Ctrl + V	Create Mirror <b>Copy Vertically</b>
Shift + V	Mirror <b>Vertically</b> , around <b>center</b> of material
Ctrl + Shift + V	Create Mirror <b>Copy Vertically</b> , around <b>center</b> of material

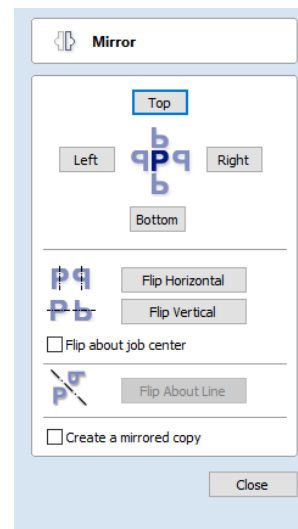

# Distort Tool



This tool allows you to bend and flex a vector by manipulating a distortion envelope using Cut2D Desktops standard node editing tools. You can select one or more vectors and then use one of the three different tool modes to create your initial distortion envelope.

Once the distortion envelope has been created, you can use Cut2D Desktops node editing tools to add or edit its nodes and spans. As you alter the shape of the envelope the associated object will be distorted to reflect the changes.

**Note:** When distorting a selection of objects which fall on different layers, the result will be created on the layer of the first object in the selection.

## Baking Distortion into an Object

Once an object has been distorted, node editing will always relate to the object's distortion envelope. If you wish to edit a distorted vector directly again, you will first need to permanently apply the distortion to the shape.

**Note:** If you select an object that already has a distortion envelope while in the Distort Object tool, the **Bake Distortion** button will be available. Clicking this button will permanently apply your current distortion and you will then be able to either distort the object again (with new settings), or node edit the shape directly.

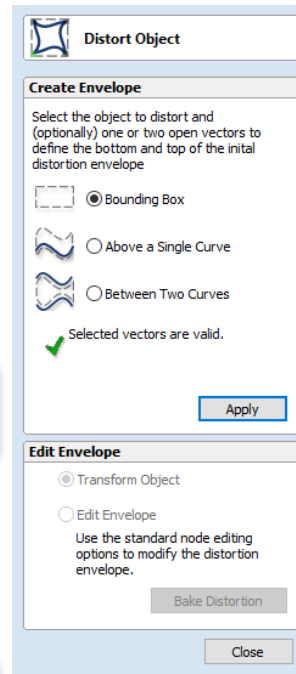

## Bounding Box

This option is available if you have a selection of vectors . It creates a distortion envelope based on the closest bounding box that can be drawn around your selection. Thus the resulting envelope is always initially a rectangle, comprising four line spans and a node at each corner. Using the normal node editing tools, however, you can modify this envelope as much as you like and the shape within it will be distorted accordingly.

## Along a Single Curve

This option is only available if the last item in your selection is an open vector that Cut2D Desktop can use to define a curve, above which the other selected objects will be distorted. The distorted object can comprise one or more vectors .

Using this option, you will usually end up with your objects bent to match the curve in your original selection. The distortion curve itself is left unchanged by this operation.

## Between Two Curves

This option will become available if the last two objects in the current selection are open vectors, between which the other objects can be distorted.

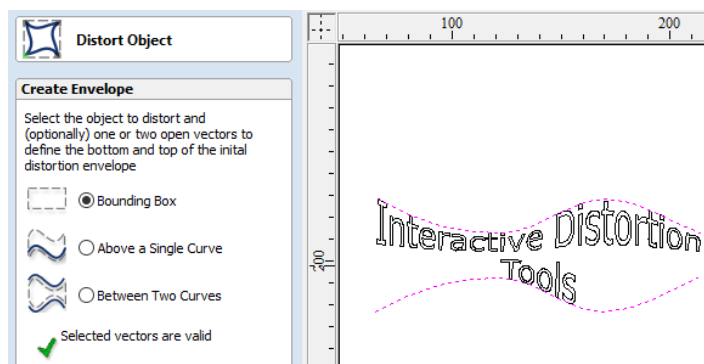

The other objects in the selection can comprise one or more vectors .

Therefore two examples of valid selections for this operation would be:

- 3 vector shapes and 2 open curves

but not:

- 1 vector shape, 1 component and 2 open curves.

The selected objects will be stretched and squeezed between the two curves that were last in the selection. Neither of the contributing distortion curves in the selection will be altered by the operation.

## Alignment Tools



The Align Objects tool provides a number of options for accurately aligning the selected object to other objects in the selection, or to the available material.

### Align Objects



The different alignment options are grouped into three sections:

1. The first section of icons all work in relation to the material (job size).
2. The second section of icons all work with regard to the selected items.
3. The last section provides options to evenly space the selected objects, or to align them inside the boundary of the last object in the selection.

### Align to Material

The options in this section will align one or more selected objects within the material workspace defined when you setup your job (the white area in your 2D View).

#### Center in Material



This option moves the selected items to be positioned in the middle of the material. The short-cut key for this is **F9**.

#### Center in Material X only



Align items centrally in the material only moving them along the X axis so the vertical position will not be changed.

#### Center in Material Y only



Align items centrally in the material only moving them along the Y axis so the horizontal position will not be changed.

### Align to Selection

The different items comprising your design in the 2D View can be aligned relative to one another using the following selection sequence:

1. Select the item/s you wish to align / move (use single or multiple selection options).
2. Hold the **Shift** key down.
3. Select the final item - this is the object that the rest of the selected items will be aligned to Click the required alignment option.

There are 7 alignment options for aligning the selection to the inside edge:

#### Align Center



Center selected items in the middle (both horizontally and vertically) of the last selected item.

#### Align horizontal center



Align the selected items horizontally centered to the last selected item.

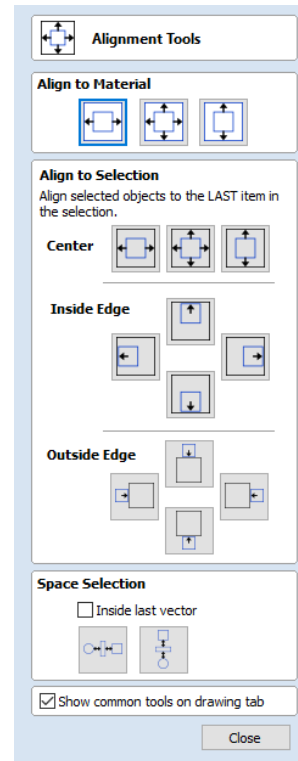

## Align vertical center



Align the selected items vertically centered to the last selected item.

## Align Left/Right



Align the selected items to the left or right edge of the last selected item.

## Align Top/Bottom



Align the selected items to the top or bottom edge of the last selected item.

There are then 4 alignment options for aligning the selection to the outside edge of the last item in the selection:

## Align Outside Left/Right



Align the selected items on the outside left or right edge of the last selected item.

## Align Outside Top/Bottom



Align the selected items on the outside top or bottom edge of the last selected item.

**Note:** If you select multiple items to align to another object then each one will be aligned individually. If you want the objects to retain their original position relative to each other when they are aligned you should Group them together before executing the alignment operation.

## Space Selection



The final section is different from the preceding two. The tools here evenly space the selected objects either between the first and last item in the selection, or, if **Inside last vector** is checked, within the boundary of the last item in the selection.

## Show common tools on drawing tab

If this option is checked, ✓ the most common alignment tools will be displayed on the drawing tab in their own section called **Align Objects**. The Alignment form can still be accessed from the original icon in the 'Transform Objects' section (or by pressing F10 ).

### Offset and Layout



# The Edit Objects Tool Group

## Edit Objects

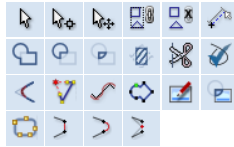

The tools relate to the design elements and objects that you can create and manipulate within Cut2D Desktop, for example vector shapes. This is where you will find the tools used to organize, edit or modify these objects.

The tool group is organized in the following way:

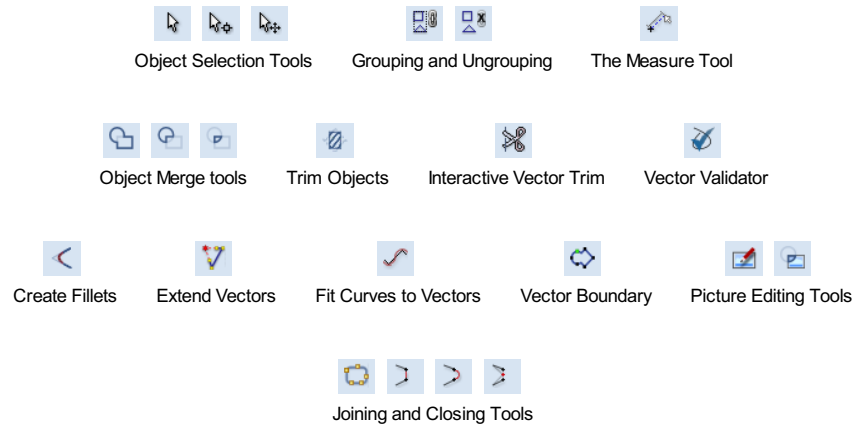



## Object Selection Tools

Once vectors have been created within Cut2D Desktop or have been imported from other design software packages you may want to make changes to them. These changes may be to prepare for machining or for use as construction vectors for making 3D shapes using the Modeling Tools. There are a number of functions for editing vectors which will be covered in this section of the manual. All the icons under the Edit Vectors section of the Drawing Tab will be referenced along with the icons under the Align Objects section of the menu.

## Editing Modes

From the 2D view a vector can be selected and then three different editing modes allow different dynamic edits to be made to the vector(s) depending on which option is selected from the Edit Vectors section.

The three editing modes are:

1.  Vector Selection
2.  Node Editing
3.  Interactive Selection

By default the software is normally in the Vector Selection mode.

## Vector Selection Mode



Selected from Edit Vectors section.

When the Vector Selection Tool is chosen, the selected vectors are shown as dotted magenta lines. Vectors need to be selected before any of the editing tools such as scaling and moving etc. can be used.

## Vector selection methods

Multiple vectors can be selected in the following ways:

1. Manual multiple selection:

Hold down the **Shift** key while clicking the Left mouse button on each vector required. Objects can be deselected by simply clicking on the object again with a **Shift** key pressed.

2. Moving the cursor from Left to Right selects only **fully enclosed** objects:





Click and drag the left mouse button moving from Left to Right selects all objects **completely inside** the selection rectangle.

- Moving the cursor from Right to Left selects all objects **inside or touching** the selection rectangle:



Click and drag the left mouse button moving from Right to Left selects all objects inside the selection rectangle + any that the selection touches.

- Pressing the keyboard keys `Ctrl + A` will select all vector objects in the design:

Selected vectors are displayed as dotted **magenta** lines.

## Deselecting Vectors

Selections can be cancelled by:

- Left clicking on an area outside the selection
- Pressing the `Esc` key
-  Pressing the Right mouse button and clicking **Selection ► Unselect All** from the pop-up menu. You must click on the white drawing background to get this option in the pop-up menu.

## Node Editing Mode

**See Also:**

- Node Editing Shortcut Keys



The Node Editing tool can be selected from the Editing window or by pressing the Keyboard shortcut `N` to toggle between Selection and Node Editing modes.

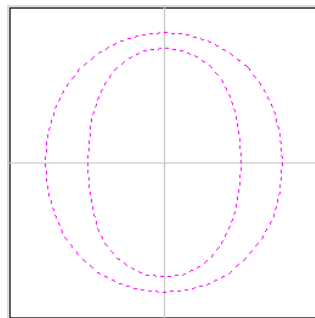

*Vectors selected*

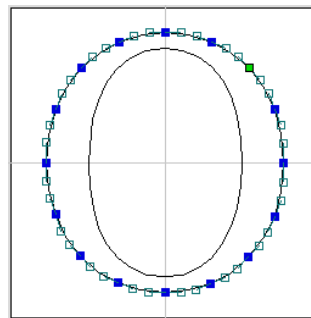

*Bezier node editing*

When the Node Editing tool is active the cursor changes to a Black Arrow indicating that individual points (nodes) can be edited. Nodes can be interactively moved by clicking and dragging the left mouse button on a node to select and move the node to a new position.

The shape of lines, arcs and Bezier (curve) spans can be edited by clicking and dragging on the nodes or control points to move them. Multiple nodes and control points can be selected and moved by using the multiple selection options such as the `Shift` key and dragging to make a selection.

If you right click on nodes or spans a context sensitive popup menu will be displayed which allows you to insert or delete points and nodes, cut the vector, move the start point etc.

Node editing vectors is a very powerful way to be able to make changes to the vectors in your part.

### Useful Tip

Smart Snapping combined with Distance Snapping or Quick Keys can give more accuracy when dragging nodes.

## Interactive Selection Mode



The Interactive Move, Rotate, Scale Selection tools can be used to quickly and easily modify vectors and components.

Clicking twice on one of the selected objects and the interactive scaling, movement and rotation handles are displayed in the same way as selecting this icon. Lines, Arcs and Bezier spans will be displayed as dotted **magenta** lines and text and grouped objects will be displayed as solid **magenta** lines:

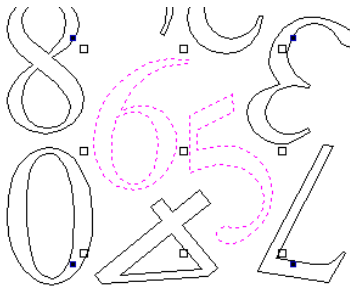

When in this mode the mouse is used to click on one of the handles which has appeared on the selected Vector/s. Each handle is used for a specific editing operation as detailed here:

Grip point	Default Action	Keyboard Overrides
Middle	Move the vectors	Alt Move the selected objects in one axis
Corner (White)	Scale the vectors proportionally.	Alt Scaling non-proportionally Shift Scale around the center
Edges (White)	Scale the vector in one axis.	Shift Scaling proportionally
Corner (Black)	Rotate the vectors	Alt Rotate in 15° increments

#### Useful Tip

Smart Snapping combined with Quick Keys can give more accuracy when dragging nodes.

To deselect objects,

- Click the white background unless **Shift** is pressed.
- Press **Esc**
- Right click menu ► Unselect All

## Grouping and Ungrouping

Grouping objects allows you to select, move and manipulate them as if they were one entity. The process is entirely reversible by Ungrouping.

### Group selected Objects



Vectors can be Grouped allowing any number of vectors to be included as a single object that can easily be selected, moved and scaled etc. The Shortcut key for this operation is **G**.

Grouping vectors is particularly useful for machining purposes, where different vectors will be used for a single toolpath operation. Clicking any member of the group will select the entire group.

### Ungroup Selection



Ungroup a set of Grouped vectors back to its individual vectors before it was grouped.

The Shortcut key for this operation is **U**.

### Ungroup to the group's layer

By default, when grouped objects are ungrouped they revert to the layers on which they had previously been located before the grouping operation. However this is sometimes inconvenient. For example, when you have copied a group of vectors to a new layer, it is easier for subsequent editing if the copied vectors to remain on the new layer, even after ungrouping. An alternative right-click pop-up menu command has been added to make this process easier.

A shortcut key combination is also available to provide support for both of the ungroup operations. In summary, therefore, the group and ungroup shortcut options are as follows:

Shortcut	Action
<b>G</b>	Group the selected objects
<b>U</b>	Ungroup the selected objects to their original layers, sub-groups remain grouped.
<b>Ctrl + U</b>	Ungroup the selected objects to the group's layer, sub-groups remain grouped.
<b>Shift + U</b>	'Deep' ungroup the selected objects to their original layers. Sub-groups are also ungrouped.
<b>Ctrl + Shift + U</b>	'Deep' ungroup the selected objects to the group's layer. Sub-groups are also ungrouped.

# Measure Tool



The Measure tool allows you to find important information about your model or drawings.

It has two modes (please note that the options available in both modes are shown in the image here for convenience of documentation, but they are not normally available at the same time).

## Measure Between 2 Points

With this option selected, you can click on two points in the 2D View and the form will report the measurements between the clicked locations

### Distance

Straight line distance between the two points.

### Angle

The angle (in degrees) of the line joining the two points, where horizontal is zero degrees and vertical is ninety degrees.

### X Distance

The separation between the two clicked points in X only.

### Y Distance

The separation between the two clicked points in Y only.

### First Point

The precise X and Y coordinates of the position first clicked.

### Cursor Position

The dynamically updated coordinates of the mouse cursor position.

## Span / Contour Properties

This mode allows you to find precise information about the individual spans of a vector shape in 2D View. Use your mouse pointer to click on any part of the shape and the information relating to the entity you have clicked will be displayed on the form.

### Type

The type of span you have clicked.

Possibilities include:

- Line
- Arc
- Bezier Curve

### Length

The length of the clicked span.

### Start Point and End Point

The precise coordinates of the node forming the start and end of the selected span.

### Vector

Information relating to the whole vector, of which the selected span is part, is shown in this section.

### Area

**Measure / Inspect**

**Measure Between 2 Points**

**Distance:**

**Angle:**

**X Distance:**

**Y Distance:**

**First Point:**

**X:** **Y:**

**Cursor Position:**

**X:** **Y:**

**Span / Contour Properties**

**Type:**

Length:

**Start Point:**

**X:** **Y:**

**End Point:**

**X:** **Y:**

**Center Point:**

**X:** **Y:**

**Radius:**

**Vector**

Area:

Perimeter:

Num. Spans:

**Close**

The total area of the selected vector

### Perimeter

The total length of all the spans forming the perimeter of the shape

### Num. Spans

The total number of spans in the shape.

## Object Merge tools

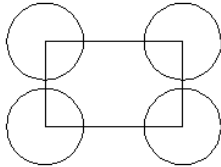

Selected closed vectors that overlap can be merged together to create a new shape. These tools consider the closed vectors to be solid areas.

The following examples begin with these five vector shapes where the rectangle was selected *last*.

### Weld Vectors

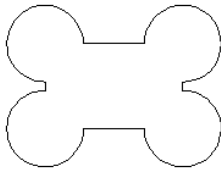

Welds overlapping vectors together to create a new shape which follows the outermost edge of all the selected shapes.

### Subtract Vectors

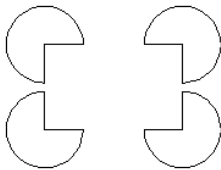

Areas in the first shapes that overlap the last selected shape are removed. In this case, the last selected shape was the rectangle, so the rectangle is cut away from the circles anywhere that overlaps.

### Keep Overlap of Vectors

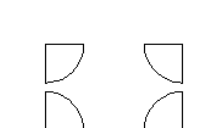

Only areas of the first selected parts (the circles) that are covered by the last selected vector (the rectangle) remain after this operation.

## Trim Objects



The trim tool allows you to trim all the objects inside a given boundary. It is much more efficient than manually trimming all the contours with the trimming scissors, and allows the trimming of closed contours, open contours and components.

To use the trim tool first select the tool by clicking the icon on the drawing tab. You then must select the objects you wish to be trimmed first and then the object you wish to trim against last. Finally, choose whether you want to clear the area inside the boundary or outside of the boundary.

If the Clear outside boundary option is selected then all the objects that intersect this boundary are clipped, and the area outside is removed. If the Clear inside boundary option is selected, then the parts of the selected objects which lie inside the boundary are removed.

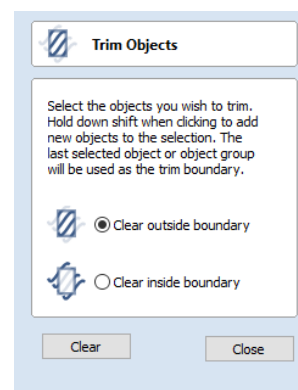

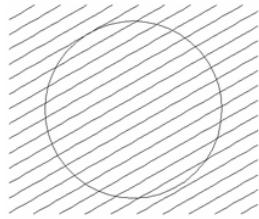

*Geometry before trimming.  
Select the lines first  
and then the circle*

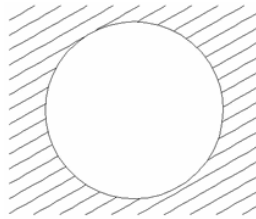

*Trimmed vectors using  
Clear inside boundary*

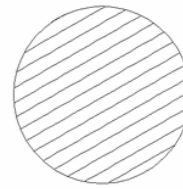

*Trimmed vectors using  
clear outside boundary*

If you want to use multiple vectors for the trimming boundary, they must be grouped for trimming. To group a collection of vectors select the vectors, right click and choose Group Objects from the drop down menu, alternatively select all the vectors and press the **G** key.

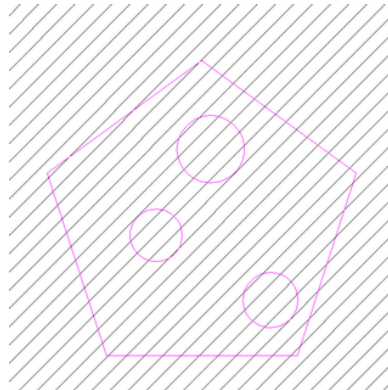

*Group the vectors you want to  
use as the clipping boundary*

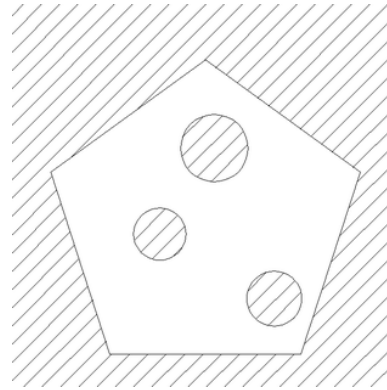

*Select the vectors you wish to clip  
followed by the grouped boundary,  
finally trim use the trimming tool.*

## Interactive Vector Trim



The interactive trimming tool allows the user to just click on sections of vectors they want to delete.

The program finds the closest intersections either side of the clicked portion of the vector and removes the piece of the vector between the intersections. Optionally, when the form for this command is closed, the program can rejoin all the remaining trimmed pieces automatically.

Without using this tool, to remove an overlapping section of a vector, the user would need to insert extra nodes into both vectors, manually delete the intermediate sections and then manually join the resulting pieces. These operations can be performed with a single click using this tool.

When the tool is selected the cursor changes into a 'closed' scissor shape. When the cursor is moved over a vector suitable for trimming the scissors 'open' to show you can click and trim.

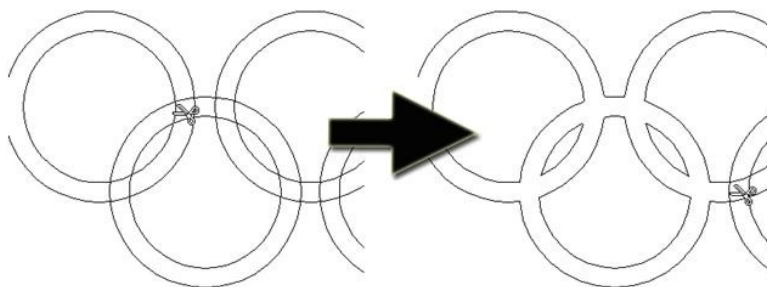

**Interactive Vector Trim**

To trim overlapping vectors click on sections of vectors you want to delete.

To delete closed non-overlapping vectors hold down the Shift key when clicking.

Rejoin trimmed sections automatically when form is closed.

The only option on the form allows the user to select whether the program will automatically try to rejoin trimmed vectors when the form is closed. For most simple cases like that shown above with the overlapping rings, this option can be left checked . If you have an example where for instance many trimmed lines meet at the same point, you may want to uncheck this option and rejoin the vectors manually.

# Vector Validator



The Vector Validator is intended to help find issues with contours after file imports that are stopping tool-path creation such as overlapping contours or intersections. It also indicates zero-length spans.

The Vector Validator dialog can be opened with a selection to work on. If there is no selection, all visible vectors on the *current Side* of the *current Sheet* on *visible layers* will be validated. The selection can be changed while the form is open.

The text on the Search button changes to show whether all vectors or just the selection are going to be searched. While searching, the **Search** button becomes a **Stop** button.

To cancel a search, click the **Stop** or **Close** button, or the cross button on the progress bar **slowly**:



**Note:** Clicking slowly gives the computer time to notice that the mouse button is down when it is very busy.

Issues found so far will be marked.

The **close** button will close the form after stopping the search.

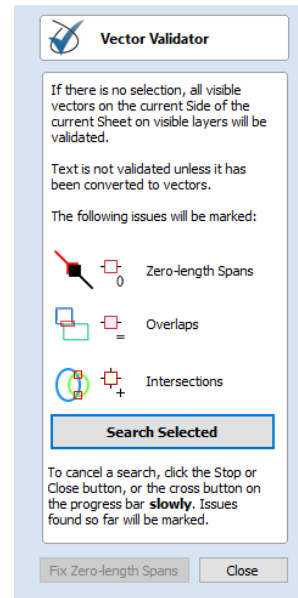

## Marks

Examples of the marks described on the form are shown below:

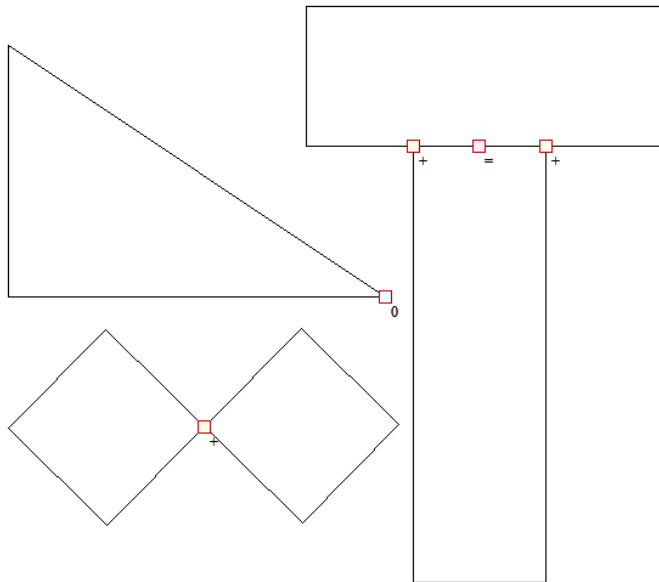

The markers do not move if you move or delete any vectors while the form is open. Markers are automatically cleared when the **Search** button is clicked or the form is closed.

Vectors can be edited (and Node-edited) while the form is open as long as a search is not in progress.

Text is not validated unless it has been converted to vectors. There is a note on the form to remind you of this.

The search will stop if 1000 issues are found.

If no issues are found a dialog will pop up saying so to confirm that the search was carried out.

If zero-length spans are found, the **Fix zero length Spans** button is enabled. Clicking this will remove the zero-length spans and clear their markers.

Each time you run the Vector Validator it may appear to find different results first.

*The order that the vectors are validated is random* because the process is multithreaded; like lots of workers moving a pile of objects onto a conveyor belt that only holds one object at a time...

Several workers may want to put an object on the conveyor belt at the same time...

The final order depends on which worker got there first, as one worker will wait a little to let another place their object on the conveyor.

Which worker waits, and how fast each worker works, varies randomly because the computer may decide that you moving your mouse around is more important than validating vectors and reassign a worker to draw the mouse for a moment, for example.

# Create Fillets



Fillets or radiuses can be added interactively at points where any two spans on a contour meet. To use the filleting tool we select the icon from the drawing tab. Choose a radius for the fillet and the type of fillet you would like to use.

When the mouse cursor is near a node that can be filleted, the mouse cursor changes to show a check-mark ✓:



When the check-mark ✓ is visible, click the left mouse button to fillet the corner.

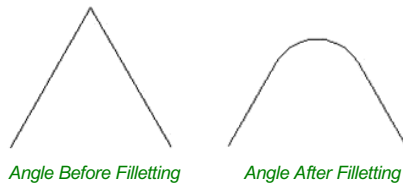

Create Fillets

---

**Fillet / Tool Radius:**  inches

Click on an angled corner to change corner into a circular fillet

**Fillet Type**

**Normal fillet**

**'Dog-Bone' Fillet**

**'T-Bone' Fillet**

**'Plasma/Drag Knife' Fillet**

**Removing Fillets**

To remove a fillet, click on the fillet arc.

Close

**Note:** Fillets can only be added to spans that are part of the same vector and as such connected, you cannot fillet between two separate vector shapes.

As well as conventional radius filleting of corners, this tool includes 2 special types of filleting for corners formed by two straight lines. They will create an overcut shaped area in corners to allow clearance for another piece of material to be slotted into the part without being obstructed by material left by the radius of the tool. Below left you can see a blue piece of material fitted into a normally cut slot, this would fit no further in than the radius of the tool would allow. Below right you can see the same situation with a slot which has the Dog-Bone style corners applied to it which allows the part to fit full depth into the slot.

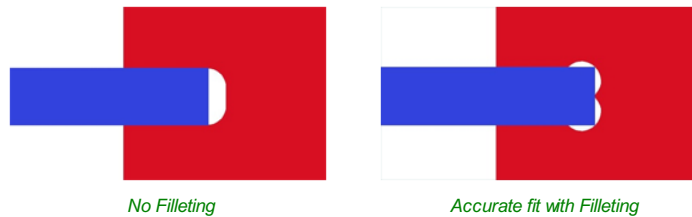

This is a very useful tool for slot-together furniture designs, model aircraft, dinosaurs etc. Below you can see a part from a slot together dinosaur assembly, on the left is the standard part and on the right is the same part with the T-Bone style fillets added to these slots. This type of fillet needs to be used when the slot is close in size to the tool diameter.

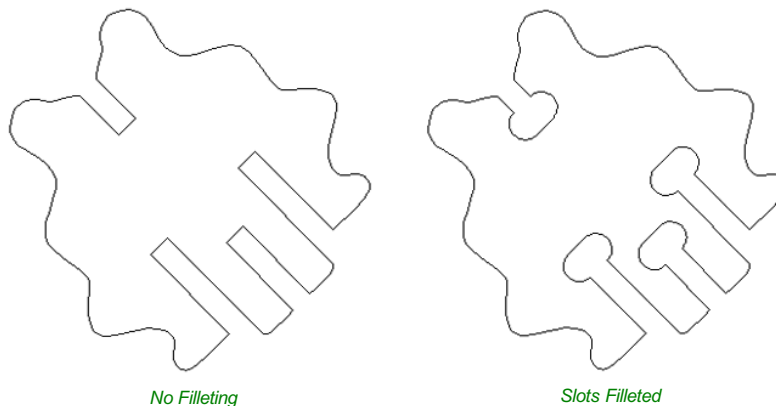

## Fillet / Tool Radius

This size of this value is used to create the fillet as described for each individual type of fillet below. To create any of these Fillets you need to select the type required, then move the mouse cursor so it is over a corner between two vector spans. If it is a legitimate place to create the fillet then a check mark ✓ will show and the user can click the mouse button to create it. It should be noted that sometimes unexpected fillets will be created if the fillet size is too big for the vector shape. In that case, simply undo the change and repeat the process with a suitable fillet size.

## Fillet Type

### Normal fillet

This creates a standard corner fillet based on the Radius defined, typically this would be used for design purposes and not for editing a slot for fitting purposes. Below left the image shows the vector before filleting the two inside radii, on the right is the filleted version.

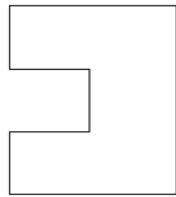

*Straight Line Span Vectors before Filleting*

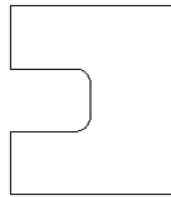

*Straight Line Span Vectors After Filleting*

Normal filleting can also be used on Bezier and Arc Spans, or a combination of all three span types (Straight lines, Arcs, Beziers) if there is enough space to create a fillet based on the specified Radius.

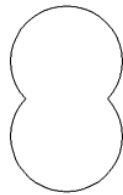

*Arc Span Vectors before Filleting*



*Arc Span Vectors after Filleting*

### Dog-Bone Fillet

This creates a circular cut-out style of fillet, the circles will be placed so the upper right part of the circle touches the original sharp corner and are created with the Radius specified. This option should not be used if the slot width and the tool are similar in size. Below left is the vector showing the slot before filleting, on the right is the filleted version using the 'Dog-Bone' option.

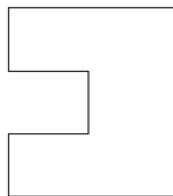

*Vectors before Dog-Bone Filleting*

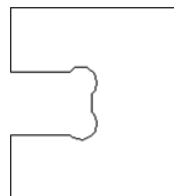

*Vectors after Dog-Bone Filleting*

### T-Bone Fillet

This creates a circular cut-out style of fillet, the circles will be created with the Radius specified. This option should be used if the slot width and the tool are similar in size so the slot can grow out to the side to ensure there is space for them to fit. Below left is the vector showing the slot before filleting, on the right is the filleted version using the 'T-Bone' option.



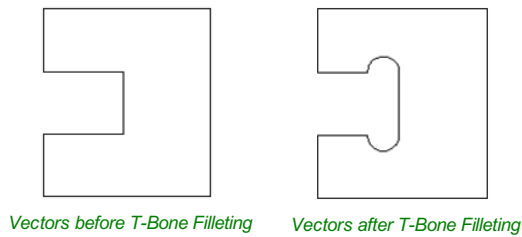

The placement of the fillet is an interactive process; you can choose which side of the 'corner' the T-bone fillet is placed. If you click on a 'corner' the fillet will be placed automatically on the longest side. By clicking to the side of the corner you want the fillet placed you can choose which side the fillet is placed on.

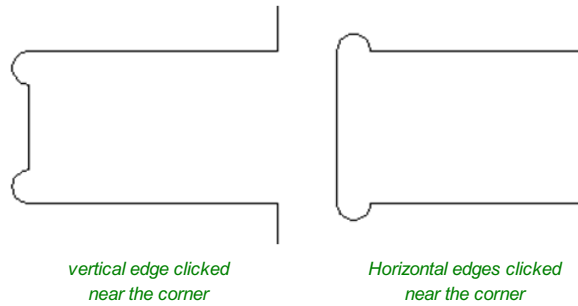

In addition, fillet arcs can be removed by simply clicking on an existing fillet arc. This works even for vectors that have been imported with filleted corners. This feature allows the user to easily change the size of fillets by clicking once to remove the existing arc and then clicking the corner to insert the new fillet. In many cases, by allowing the user to control which side of the corner the 'T-Bone' fillet is placed on means that the fillet can be hidden when the pieces are assembled.

**Note:**  
You cannot remove fillet arcs from .eps files as they do not contain arcs and only contain straight lines and Bezier Spans.

## Removing Fillets

Fillets can be removed in the same way that we add fillets: move the cursor over the fillet that you wish to remove. If this fillet can be removed then the cursor shows a cross to indicate that it is possible to remove a fillet:



Clicking removes the fillet:

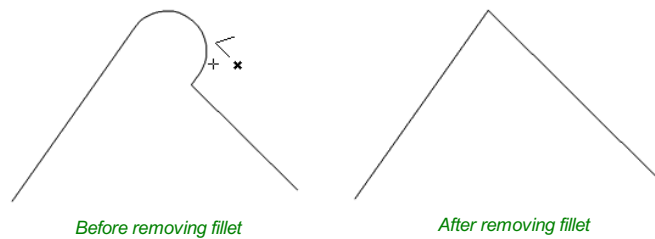

When removing fillets the software does not store what kind of geometry the fillet was created from. It always defaults to using straight lines to return the fillet to a sharp corner. As such if the fillet is across multiple spans or is derived from arcs or Bezier curves then it will not go back to its original state and instead it will remove the radius and extend two straight lines to create the new corner. Below are images that show this effect, the first set show the whole vector and the second show a section of the vector in node edit mode to help show the difference. If the fillet was created recently then it may be possible to use the Undo command to return it back to its original geometry.

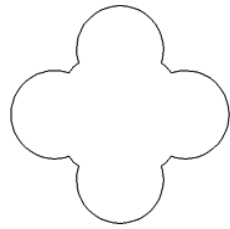

Original Vector

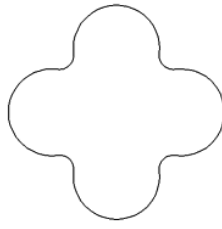

Vector with Fillets

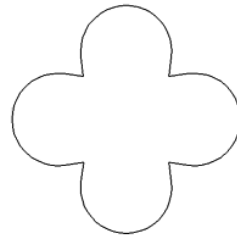

New Vector after Removing Fillet

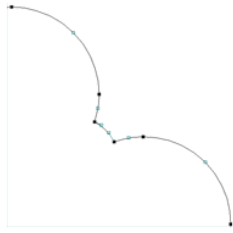

Original Vector in Node Edit Mode

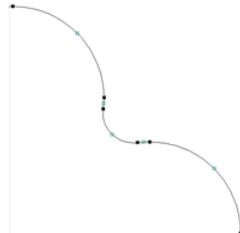

Vector with Fillets in Node Edit Mode

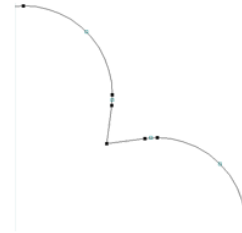

New Vector after Removing Fillet in Node Edit Mode

## Extend Vectors



This tool allows you to extend two vector lines to their common point of intersection. The tool form is rather sparse, but that is because all the action occurs directly in the **2D View**.

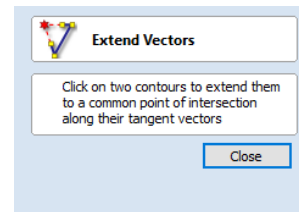

With the **Extend Vectors** tool active, moving the mouse pointer over the ends of open vector shapes (without clicking) will highlight a dashed preview extension line from that shape. The line will change dynamically as you move the mouse over the end spans of different open shapes. Clicking with the left mouse button at this point will set it as the target line to extend and the magenta line will remain visible.

The mouse can now be moved over existing spans along the length of the preview extension line, or over the end of another shape to create a second, intersecting, preview extension line.

Clicking on any of the intersection points indicated by the mouse cursor will extend the initial shape to that point and complete the operation.



First click creates a preview extension line from the selected vector span.

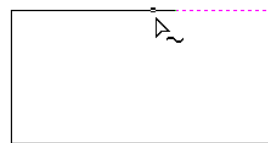

Moving the mouse over another span will display a second preview extension line to the point of intersection. Click the line to apply this change.

The tool can be closed at any time using the  button on the form. Right-clicking in the **2D View** will reset the tool so that it is ready to select another target line to extend.

# Fit Curves to Vectors



This function allows the user to fit arc, Bezier curves or straight lines to selected vectors. The newly created vectors will be approximated based on a user defined tolerance. Using this function can aid with smoothness for some toolpath options and also help to simplify data for modeling purposes.

The Curve Fitting function can be accessed from the Edit Objects area of the Drawing Tab, the **Edit Menu** ► **Curve Fit Vectors** in the Main Menu or by using the short-cut-key combination **Ctrl + F**.

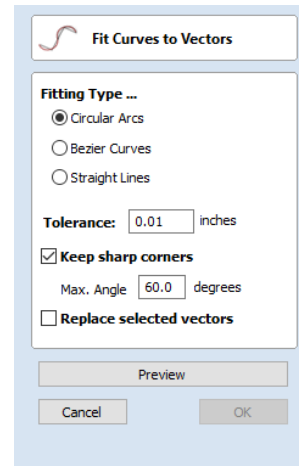

## Fitting Type...

### Circular Arcs

Checking  this option means the selected vectors will be approximated using arcs:

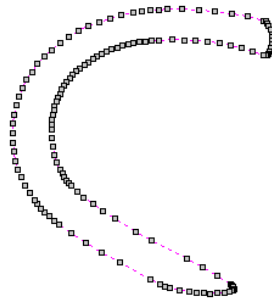

*The vector before fitting*

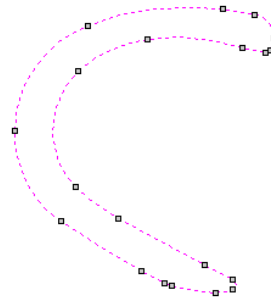

*The same vector fitted with arcs*

### Bezier Curves

Checking  this option means the selected vectors will be approximated using Bezier curves.

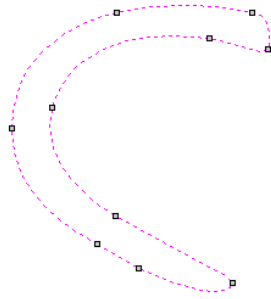

*The same vector fitted with bezier spans*

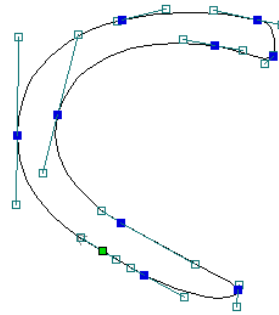

*The same bezier spans in Node-edit mode*

### Straight Lines

Checking  this option means the selected vectors will be approximated using straight lines.

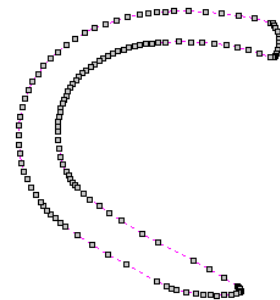

*The vector before fitting*

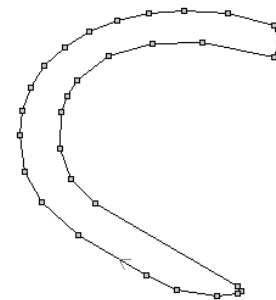

*The same vector fitted with straight lines*

### Tolerance:

The value which is set in the Tolerance area determines how closely the original vectors will be approximated. The newly

created, Arcs, Beziers or Lines will be generated within a distance of the original vector which is plus or minus the specified Tolerance value. The smaller the value the closer to the original the new data will be but it will also mean more data points will be used. A larger Tolerance will not be as accurate to the original but will have less data points. The diagram below shows the curve fitted to two straight lines with the max possible distance between them defined by the Tolerance set. The tolerance is the distance indicated with the red arrow:

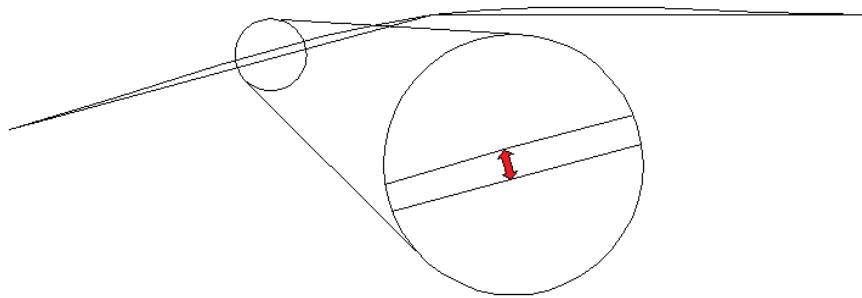

The same vector fitted with straight lines

## Keep Sharp Corners

Checking  this option will make the Curve Fitting routine keep sharp corners which have a difference greater than the Max Angle value specified. Any corners where the difference in angle is less than this value will be modified within the specified tolerance. The images shown below demonstrate how this works. The first image shows a set of straight lines before curve fitting with the angles shown between the spans. The second image shows this after curve fitting with the Keep sharp corners set with a value of 20°. You can see the two lines which were under the 20° difference have had a curve fitted between them but the other corner which has been retained as the original angle is greater than 20°.

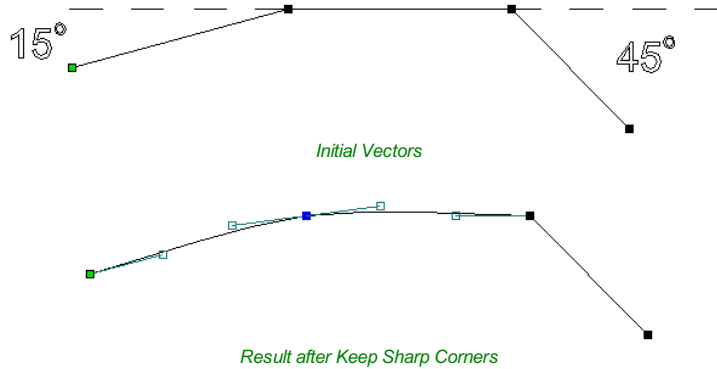

## Replace selected vectors

Checking  this option will delete the current vectors and replace them with the new curve fitted vectors. Un-checking it will keep the original vectors as is and in addition create new curve fitted vectors. The new vectors will always be created on the currently selected Layer.

## Vector Boundary



The Vector Boundary form allows you to create boundaries around selected vectors.

You can offset the boundary outwards and optionally create convex or 'Rubber band' boundaries.

**Vector Boundary**

**Offset boundary**

Distance:  inches

**Rubber band boundary**

When this is checked a rubber band is placed around the selected vectors to form a boundary and no attempt is made to weld vectors together.

Create
Close

### Offset Boundary

When this is checked  the created boundary is offset outwards by the distance specified.

### Rubber Band Boundary

When this is checked  the created boundary is the result of stretching a rubber band around the currently selected vectors.

The images below demonstrate the difference between the two types of boundary that the form creates. The picture on the left illustrates the standard offset output and the one on the right shows the result when Rubber band boundary option is checked .

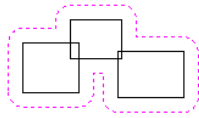

*Offset Boundary only*

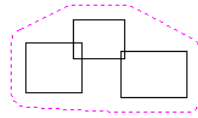

*Offset Boundary and Rubber Band together*

## Edit Picture



The Edit Picture form allows you to add a border to, and edit the properties of a selected bitmap.

### Contrast

This slider adjusts the contrast. A higher contrast emphasises the differences between the light and dark parts of the image.

### Brightness

This slider adjusts the brightness of the image.

### Gamma

This slider adjusts the gamma correction applied to the image. This can make an image look lighter or darker whilst maintaining detail.

### Invert

Inverts the colors in the image. White becomes black and black becomes white.

### Grayscale

Makes the image black and white.

### Add Border

Fades the edges of the image based on the border type and the width of the fading.

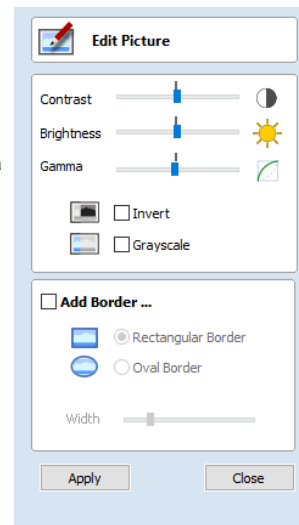

*Rectangular Border*



*Oval Border*

## Crop Bitmap



Select the image you would like to crop. Then using `shift` + left click select the closed vectors you would like to use to crop the image. You may select multiple vectors but the image must be selected first. Click the crop bitmap button to clear the image outside of the vector. If multiple vectors are used for the cropping then the crop tool leaves only the area of the image that lies inside the selected contours.



## Joining and Closing Tools

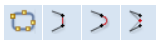

The icons to join and close vectors are located under the Edit Vectors section of the Drawing Tab.

### Join Open Vectors



This icon opens the Join Vectors Form

Open vectors are automatically identified and closed or joined to other vectors where the end points lie within the user definable tolerance.

**Join Vectors**

**Selected vectors:**  
 Closed: 1  
 Open: 0

**Tolerance:**  
 inches

**Vectors after joining:**  
 Closed: 1  
 Open: 0

### Join/Close vectors with a straight line



Join with a Line finds the closest end points on 2 selected, open vectors and joins with a straight line. Close with a Line closes a single open vector with a straight line between its two end points.

### Join/Close vectors with a smooth curve



Join with a Curve finds the closest end points on 2 selected, open vectors and joins them together with a smooth curve.

Cut2D Desktop has two smooth joining methods:

- A smoother method (new for V9.5)
- A more symmetrical shallower join method

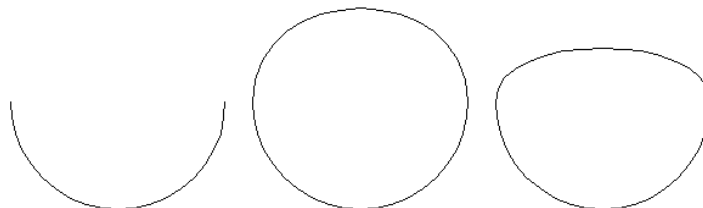

*Example of smoother joining (left) versus symmetrical joining (right)*

By default then the smoother method is used. However the default method can be chosen from within the options dialog. **Edit ► Options ► Smooth Join Vectors** The alternative method can be triggered by holding down the `Ctrl` key when pressing the smooth button.

## Join/Close by Moving End Points



Join Moving End Points finds the closest end points on 2 selected, open vectors, calculates the mid-point between them and moves the end points to this position.

# The Offset and Layout Tool Group

## Offset and Layout

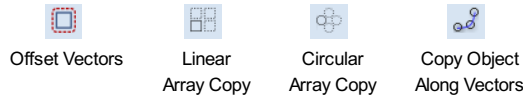

This tool group includes tools to create offset versions of existing objects or to layout objects automatically.

## Offset Vectors



Selected vectors (open or closed) can be offset either inwards or outwards to create new vector shapes that might be useful for edge patterns or borders etc. To offset a vector shape, use the following steps:

1. Select the vectors to offset
2. Select the required direction - Outwards / Right or Inwards / Left
3. Enter the Distance
4. Click the **Offset** button

## Options

The offsetting options are slightly different in their behavior depending on whether the vector to be offset is open or closed. See below for more information.

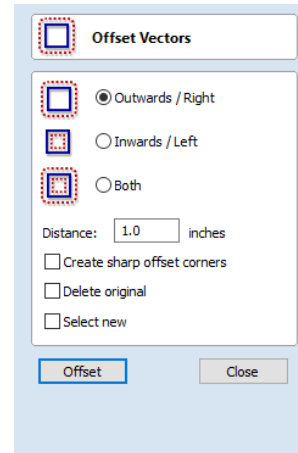

## Create sharp offset corners

Will retain any sharp corners in a design.

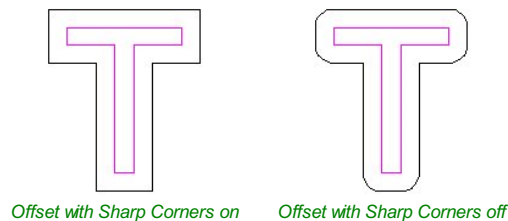

## Offsetting Open Vectors

When offsetting open shapes, the options are either to the Right or Left side of the selection. The direction of open vector(s) is very important as this is used to decide the right and left side of the selection. Selecting Node Edit mode (pressing N on the keyboard) will display a Green node at the start of the vector. Looking along the vector(s) from the green node indicates the direction and the image below shows offsets to the left and right of an open vector.

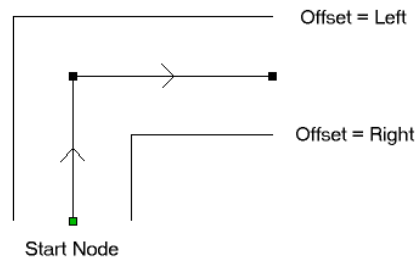

## Notes

Square Offsetting a very acute (included) angled sharp corner will result in the corner point being positioned a long way from the original geometry, often off the material or cutting through other shapes in the design. To stop this happening Cut2D



Desktop checks that the distance for the new calculated offset point is less than 5 x the offset distance away from the original corner point.

**Note:** Offsetting overlapping vectors can cause unpredictable results. It is generally better to merge overlapping vectors before offsetting them.

## Array Copy



This tool will automatically create copies of the selected object and lay them out in a grid pattern. The grid size is determined from the number of row and columns requested and the spacing of the object copies can be set directly as a gap distance, or in terms of an offset distance between each copy's position.

**Note:** You can use the menu item *Edit ⇒ Undo* or the **Ctrl + Z** shortcut key to undo the action of this tool while the form is still open. This allows you to easily experiment with different options.

### Selected Objects Size

Reports the current size of the selection that you are intending to block copy. This is for information only, but the values can be selected, copied and pasted to use in other calculations.

### Rows and Columns

These options specify how many rows and columns of the selected object to create. The total number of copies made will be X multiplied by Y.

### Spacing...

There are two ways to specify the spacing between elements in array:

#### Gap

The X and Y fields will be used to specify the gap between edges of each object copy.

#### Offset

The X and Y fields are used to define the offset of the position of each object copy, relative to the preceding one.

This example shows a sign blank copied to create a 3 x 3 array.  
3 Rows x 3 Columns with a Gap of 0.3 inches between each object:

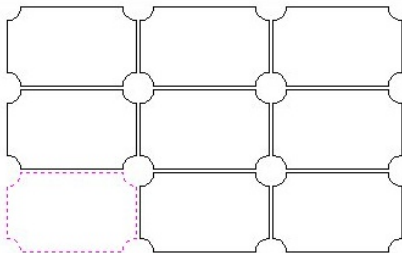

### Symmetry...

The symmetry area of the form gives you the ability to mirror and rotate objects. This allows for more advanced pattern making, by default the block symmetry form is set so there is no symmetry or rotation. To alter the pattern you can simply press the block symmetry buttons to create your desired pattern.

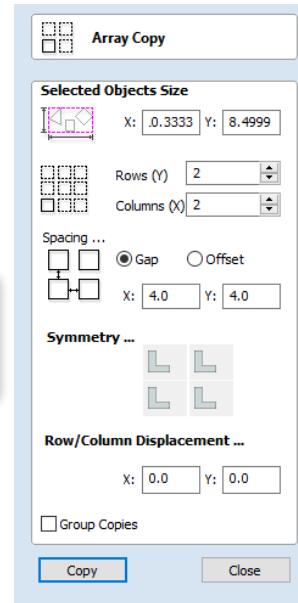

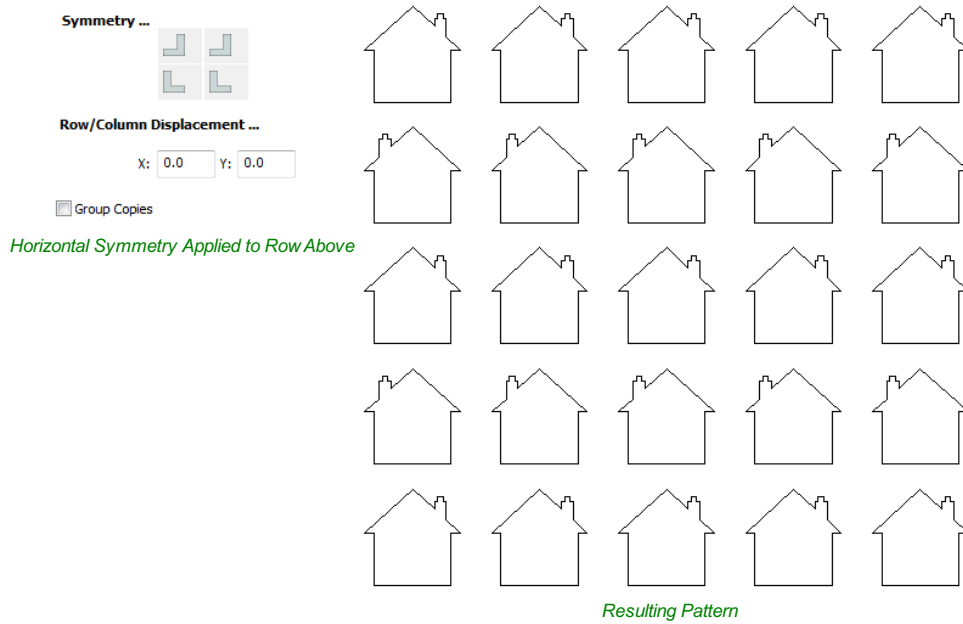
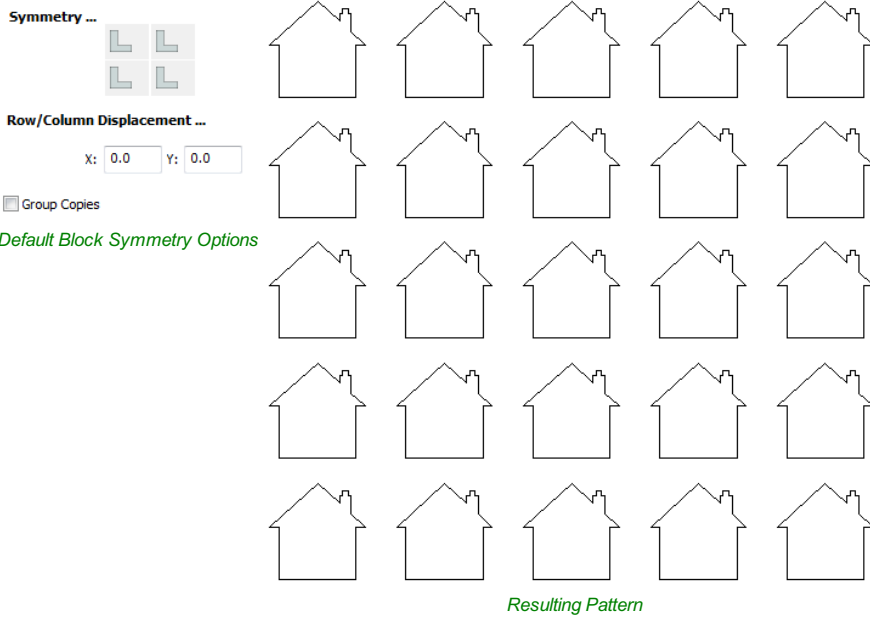

### Row/Column displacement...

Entering values in the Row/Column displacement allows you to move a row or column by the value specified.

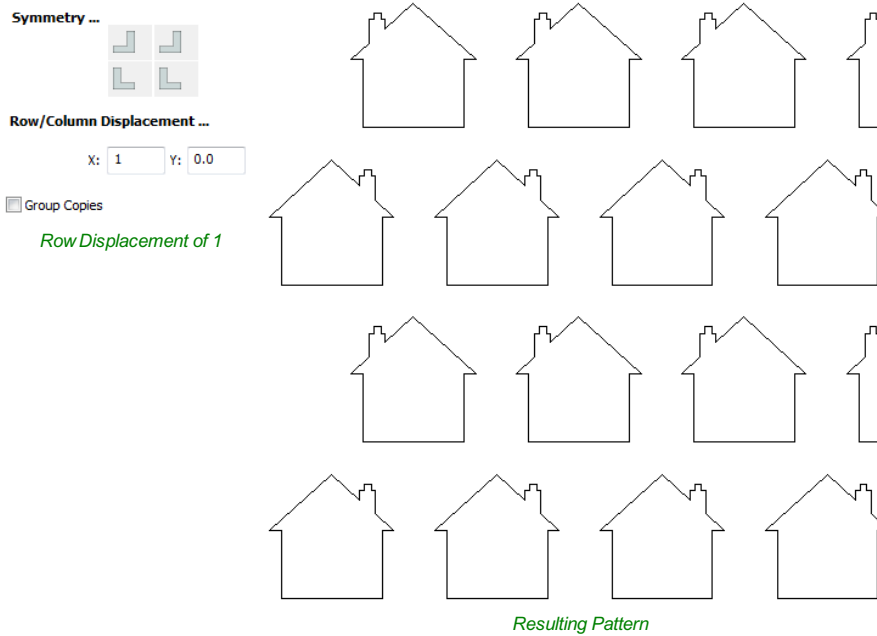

## Group Copies

Having this option checked  will group the objects that you have created in the form when you hit the **Copy** button.

## Circular Copy



This tool will automatically create a repeating pattern by making copies of the selected object and positioning them around a full or partial circle. The number of copies to be made can be entered directly.

**Note:** You can use the menu item **Edit ⇒ Undo** or the **Ctrl + Z** shortcut key to undo the action of this tool while the form is still open. This allows you to easily experiment with different options.

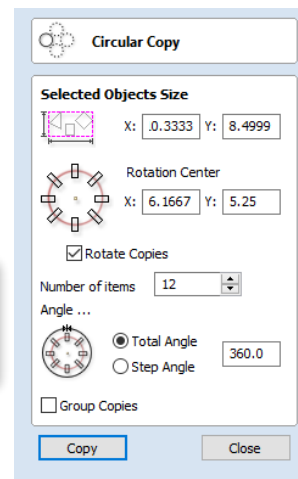

## Rotation Center

This is the absolute XY coordinate around which the objects will be rotated when copied and pasted. The default Rotation point is the middle of the selection. You can set the rotation center coordinates explicitly using the X and Y edit boxes on this form or by clicking the selected geometry to show the transform grips, then double-clicking the center one to show the pivot-point and dragging the Pivot Point handle associated with the selection in the 2D View:

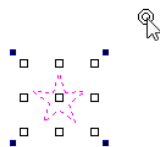

## Rotate Copies

This option controls whether the copied objects are each rotated as they are placed around the circle, as shown in the diagrams below. If this option is selected, each copy is rotated according to its position on the circle. If the option is not selected then each copy maintains the orientation of the originally selected object.

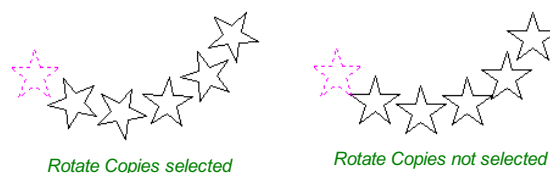

## Angle

**Note:** A **Negative** Step Angle pastes the copies in a **counter-clockwise** direction.

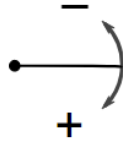

A **Positive** Step Angle pastes the copies in a **clockwise** direction.

## Total Angle

With this option selected the number of items is divided into the Total Angle to give the incremental angle between each object.

## Step Angle

With this option selected this angle is used to copy the selected vector(s) by this angle x the number of Items.

**Note:** Using **Edit** ⇒ **Undo** deletes all the pasted copies and leaves the original vector selected.

## Copying Multiple Vectors

The result of one array copy can be used for another to create more complex patterns, this one being used for an engraving. The rotation point has been set by double-clicking the centre grip, then dragging to the desired location:

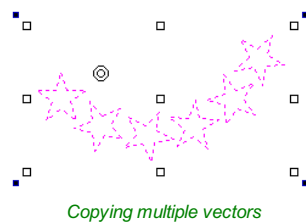

Copying multiple vectors

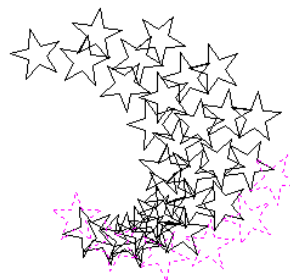

Result of Copying Multiple Vectors

## Copy Along Vectors



This tool automatically creates repeating patterns of objects by placing copies of them along the length of one or more selected vectors. The tool allows any existing object to be used but it also has an option specifically for the creation of circles, which is a common design element for patterns of this sort.

**Note:** You can use the menu item **Edit** ⇒ **Undo** or the **Ctrl + Z** shortcut key to undo the action of this tool while the form is still open. This allows you to easily experiment with different options.

To make copies of an existing object, select the item to copy, then holding a **Shift** key down to facilitate multiple selection, select the vector curve or curves you wish to paste the item along. Make sure the **Copy Object** option is highlighted and click **Copy**.

If you wish to create circles, then you simply need to select one or more vectors along which the circles will be created. Ensure the **Copy Circles** option is highlighted and click **Copy**.

## Copy Object

### Copy Along Vectors

**Copy object**  
Select object to copy followed by one or more vectors to create copies along.

**Copy Circles**  
Diameter  inches

Specify ...

**Distance between copies**  
 inches  
 Force even spacing

**Number of copies**

Align objects to curve  
 Create copies on new layer  
 Reverse direction

**Copy** **Close**

Any shape vector or group of vectors can be copied along a curve or curves. The first vector or group of vectors selected is the object that gets copied multiple times along the curves.

## Copy Circles

Enter the diameter of the required circles

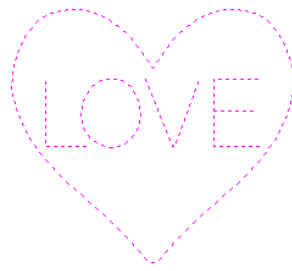

*Selected Vectors*

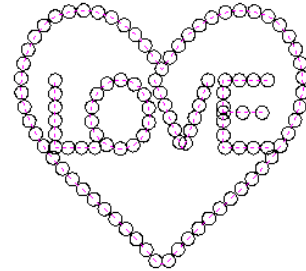

*Circles Copied along curves*

## Distance between copies

This is the distance along the selected curve between each pasted vector. The Force even spacing option ensures that objects are pasted at the end points on the curve(s). If this option is not selected the pasted objects will be placed at the specified distance and may not match the exact length of the curve.

## Number of copies

Selecting a specific number of copies automatically sets the specified number of copies along the entire length with an even spacing between them.

## Align Objects to curve

With this option selected the pasted objects are automatically aligned 'normal' or perpendicular to the curve they are being copied onto. If this is not selected, the copied objects stay in the orientation of the original.

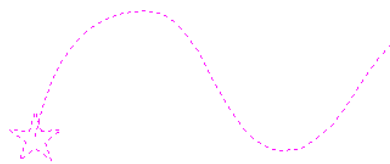

*Selected Vectors*

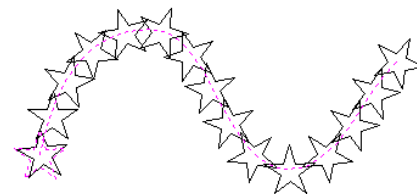

*Stars Copied along the curve*

## Create Copies on new layer

This option creates the multiple copies on a new layer making it much easier to select and organize the resulting vectors for machining purposes etc.

## Reverse Direction

If your copies appear upside down, this option will perform the copy operation in the opposite direction along the selected vectors and the resulting copied shapes will be created the other way up.

# Toolpath Operations

**See Also:**

- Toolpaths Overview
- The Toolpath List

**Toolpath Operations**



Basic Toolpaths



Laser Toolpaths (available with Laser Module)



Toolpath Editing Tools



Preview, Estimation, Tiling and Saving

# Toolpaths

The ultimate purpose (in almost all applications) of Cut2D Desktop is to allow you to generate toolpaths which can be run on a CNC machine to machine the finished part in the material of choice. This requires, at a minimum, some vectors to describe the area to which a toolpath will be limited to. The process for creating toolpath is as follows:

## Prepare vectors for machining

Optionally organize the vectors you will be using for machining onto appropriate layers.

## Set up the Material

Check the overall material size (Job Setup) to ensure it matches or exceeds the size of the finished product.

Use the Material setup form from the Toolpaths Tab to set the reference Z datum for the part relevant to the CNC machine.

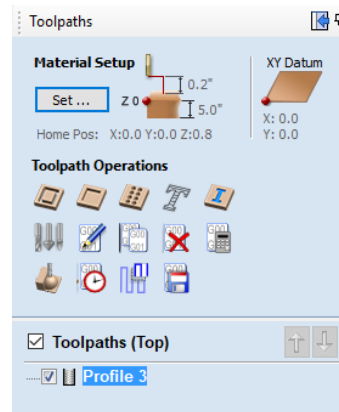

## Create the Toolpaths

Work through the toolpath strategy icons you wish to use to machine the job to calculate all the required toolpaths.

## Preview the Toolpaths

Either after you create each toolpath or at the end of calculating them all, the user has the option to preview the toolpaths to see what they will actually look like in the 3D view. This is a very important step to verify position, detail and the look of the overall finished part.

**Note:** The Preview is a very accurate representation of the final toolpath. If the Preview does not look correct then you should always go back and alter the problematic toolpath. Issues present in the Preview will almost certainly be reproduced on the CNC machine.

## Save the Toolpaths for the CNC machine

After choosing the appropriate Postprocessor from the list, the toolpaths can be saved in a format which is ready for the CNC to cut. Depending on the toolpaths calculated and the options the Postprocessor/CNC you are using supports, you may be able to save a single file or it may need multiple files to be saved - one for each tool type.

All the stages will be covered in the supplied Tutorial videos that include Machining. It should be noted Stage 1 is done through icons already covered from the Drawing Tab. Stages 2 to 5 use icons from the Toolpath Tab (on the right hand side of the screen). These will be covered in the next section.

## Additional Toolpath Tab Features



### Switch to Drawing Tab



Closes the Toolpath Tab (right hand screen form) and opens the Drawing Tab (left hand drawing form)



The pin icon is described in the section: Accessing Auto-hidden tabs

### Toolpath Summary Area

When a toolpath is selected from the Toolpath list with no other function being used in the Toolpath Tab a text summary of the toolpaths settings is shown in the body of the Toolpath Tab below the icons. This is a very useful way to recall settings for a toolpath without opening it.

# Material Setup

- Flat Job

The **Material Setup** section of the Toolpaths tab provides a summary of the current material settings. Some of these values will have been initially set when the job was first created (see Job Setup for more information). When you come to creating toolpaths, it is important to review this information and ensure it is still valid and also to set the machining clearances. To access all these properties for editing, click on the **Set...** button to open the **Material Setup** form:

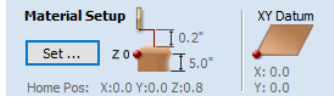

## Flat Material Setup

### Thickness

Enter the thickness of the material being machined.

### XY Datum

This allows you to set the X and Y origin of the job. See the section in Job Setup form

### Show detailed summary on toolpath tab

This checkbox toggles the Material Setup summary layout on the Toolpaths tab between simple and detailed views.

### Side Z-Zero

Select relative to the Material Surface or relative to the Machine Bed. This is a very important setting because the tooling used on the CNC machine must be setup in the same way, ensuring the toolpaths cut to the correct depth.

If you are working in a 2 Sided job, this will set the Z Zero for your current side only,

- The side you are setting up will be displayed in brackets e.g. (Top).
- You can set the Z-Zero for both sides through the Job Setup form.

## Rapid Z Gaps above Material

### Clearance (Z1)

This is the height above the job at which it is safe for the cutter to move at rapid or maximum feed rate. The software will raise the bottom of the cutter to this height when it traverses the material.

### Plunge (Z2)

For all toolpaths, as well as specifying a rapid clearance gap for rapid positioning moves above the workpiece, the user can also specify a much smaller gap that the tool will rapid down to during plunge moves. By default the plunge gap is set to the same value as the Clearance gap which means that there will be no rapid plunges. If you set the plunge gap to a smaller value than the Clearance gap, the tool will plunge at rapid feed rate to the specified distance above the material surface before changing to the specified plunge rate. For jobs where a large value for Clearance gap has to be specified to avoid clamps etc, this feature can save a considerable amount of machining time if there are a lot of plunge moves in the job.

**Note:** Some engraving machines are not able to take advantage of this feature.



## **Home / Start Position**

This is the absolute position that the tool will start moving from and where the tool can be programmed to return to at the end of cutting the job.

# The Toolpath List

The Toolpath List is located at the bottom of the Toolpath Tab (toggle tab visibility using Shortcut key **F12** ).

This area displays in a list, the name of each calculated toolpath with a check-box to turn the visibility of the toolpath in the 3D View on and off. The icon next to the check-box shows the type of tool selected for that particular toolpath.

Double clicking the name of any of the toolpaths will open up the toolpath strategy window for that toolpath and allow edits to be made to it.

The up and down arrow icons to the right of the window allow the user to move a toolpath up and down in the list. This will affect the order the Toolpaths are previewed in and if multiple toolpaths are saved as a single file, then this will be the order that the machine cuts them in.

You can adjust the space available for the Toolpath list by clicking and dragging the divider that separates the Toolpath List from the Toolpath Operations section, up or down.

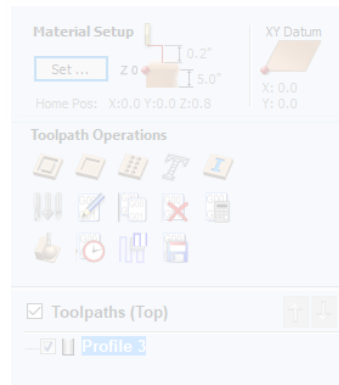

## Resizing the Toolpath List

The toolpath list can be resized by clicking on the divider between the toolpath list and toolpath commands area and dragging.

# Basic Toolpaths

The basic toolpaths section of the Toolpath Operations icons can be found on the Toolpaths tab, underneath the Toolpath list. It includes the Material setup command, which will often need to be used before any toolpaths are created. This section also includes Profiling, Pocketing and Drilling strategies. The Quick Engrave strategy is a specialist strategy for some engraving machines.

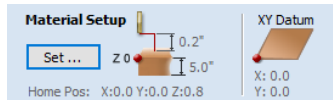

Material Setup



## Profile Toolpath



Profile Machining is used to cut around or along a vector. Options provide the flexibility for cutting shapes out with optional Tabs / bridges plus an Allowance over/undercut to ensure perfect edge quality.

Profile toolpaths can be outside, inside or on the selected vectors, automatically compensating for the tool diameter and angle for the chosen cut depth.

When working with open vectors the profile toolpaths can be to the Left, to the Right or On the selected vectors.

Clicking this icon opens the 2D Profile Toolpath form which is shown at the right; the functions in this form are described on the following pages.

If you have vectors which are nested (like the letter 'O'), the program will automatically determine the nesting and cut the correct side of the inner and outer vectors. In addition, the program will always cut the inner vectors before the outer vectors to ensure the part remains attached to the original material as long as possible.

### Cutting Depths

#### Start Depth (D)

Specifies the depth at which the Profile toolpath is calculated. When cutting directly into the surface of a job the Start Depth will usually be 0. If machining into the bottom of an existing pocket or stepped region, the depth of the pocket / step must be entered.

#### Cut Depth (C)

The depth of the profile toolpath relative to the Start Depth.

#### Tool

Clicking the Select button opens the Tool Database from which the required tool can be selected. See the section on the Tool Database for more information on this. Clicking the Edit button opens the Edit Tool form which allows the cutting parameters for the selected tool to be modified, without changing the master information in the database. Hovering the mouse cursor over the tool name will display a tool tip indicating where in the Tool Database the tool was selected from.

## Pass Depth Control for Profiling

When a profile toolpath is created, the **Pass Depth** value associated with the selected tool (part of the tool's description in the Tool Database) is used to determine the number of passes needed to profile down to the specified **Cut Depth**. However, by default Cut2D Desktop will also modify the precise step down by up to 15% in either direction, if by doing so it is able to total number of

passes required to reach the desired cut depth. It is nearly always desirable to benefit from the significantly reduced machining time of cutting profiles using less passes if possible. Nevertheless, there are some occasions where the exact step down for a given profile pass needs to be more precisely controlled - when cutting into laminated material, for example. The **Passes** section of the **2D Profile Toolpath** page indicates how many passes will be created with the current settings.

The **The Edit Passes...** button will open a new dialog that enables the specific number and height of passes to be set directly.

## Specify Pass Depths

The **Pass Depths** section at the top of the form shows a list of the current pass depths. The relative spacing of the passes is indicated in the diagram next to the list. Left click on a depth value in the list, or a depth line on the diagram, to select it. The currently selected pass is highlighted in red on the diagram.

To edit the depth of the selected pass, change the value in the **Depth** edit box and click **Apply**.

The **Delete** button will delete the selected pass.

The **Clear All Passes** button will delete all the passes.

To add a new pass, double left click at the approximate location in the passes diagram that you wish to add the pass. A new pass will be added and automatically selected. Edit the precise **Depth** value if required and then click **Apply**.

The **Set Last Pass Thickness** option will enable an edit box where you can specify the last pass in terms of the remaining thickness of material you wish to cut with the last pass (instead of in terms of its depth). This is often a more intuitive way to specify this value.

## Pass Depth List Utilities

This section of the form includes two methods for creating a set of passes in one go.

The first method simply sets the passes according to the Pass Depth property of the selected tool. By default, this is the method used by Cut2D Desktop when it creates profile passes initially. However, the **Maintain exact tool pass depth** option checked, ✓ Cut2D Desktop will not vary the step size to try and optimize the number of passes (see above).



The second method creates evenly spaced passes according to the value entered in the **Number Of Passes** edit box.

To apply either method click the associated **Set Passes** button to create the resulting set of pass depths in the passes list and diagram.

**Note:** Setting the number of passes with either of these utilities will discard any custom passes you may have added.

## Machine Vectors...

There are 3 options to choose from to determine how the tool is positioned relative to the selected vectors/s.

- Outside  Calculates a profile toolpath around the Outside of the selected vectors, with options for the cut direction to be either,  
Climb (CW) cutting direction or Conventional (CCW) cutting direction
- Inside  Calculates a profile toolpath around the Inside of the selected vectors, with options for the cut direction to be either;  
Climb (CCW) cutting direction or Conventional (CW) cutting direction
- On  Calculates a profile toolpath around the On the selected vectors, with options for the cut direction to be either,  
Climb (CW) cutting direction or Conventional (CCW) cutting direction

## Direction

Can be set to either Conventional or Climb machining where the cutting direction depends upon the strategy selected - see above for details. Using Climb or Conventional cutting will largely be dictated by the material is being machined and the tooling.

## Allowance offset

An Allowance can be specified to either Overcut (negative number will cut smaller) or Undercut (positive numbers will cut larger) the selected shape. If the Allowance = 0 then the toolpaths will machine to the exact size.

## Last Pass Allowance

A separate allowance can be specified for the last pass. If this allowance is given then all but the last pass will be undercut by the specified allowance with the final pass being the only pass which cuts to size.

**Note:** This is intended to be just a thin skin of material to be cut away as the tool will have to cut through this allowance at the full depth of the cut where all the previous passes undercut. There will be a warning displayed if the last pass allowance is greater than 1/3rd of the tool diameter but the last pass allowance should ideally be kept a lot smaller than this. Keeping this as small as possible reduces the chances the final pass will fit in areas where the previous passes will not and reduces the amount of material the last pass is having to cut through. If using a last pass allowance for the toolpath you should check that you are happy with the amount of material left for the last pass to cut through. The toolpath will fail to calculate if the last pass is cutting a significant distance into material which has not been cleared by the previous passes.

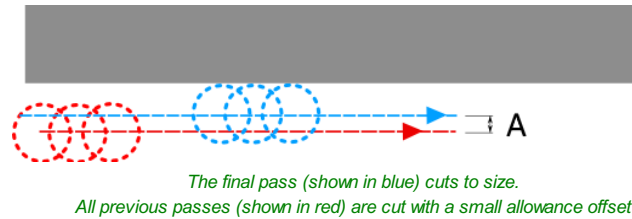

If the **Reverse direction** button is checked ✓ then the cutting direction of the last pass is reversed. This feature is can be useful if for minimizing witness marks on the edge of profile cuts.

The last pass allowance will also take into account any allowance offset and so the two options can be used together.

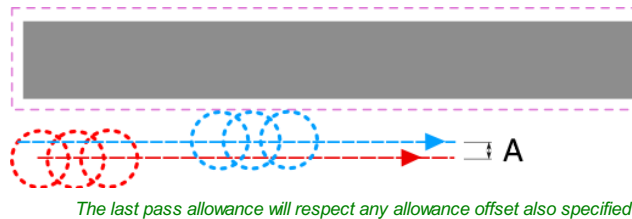

## Use vector start point

Use Start Point can be selected to force the toolpath to plunge and start cutting at the first point on the shape. This is very useful if you need to ensure the cutter doesn't plunge onto a critical part of the job. For example, setting the Start Point to be on a corner will often be the best position to plunge and cut from as this will not leave a witness / dwell mark on the machined surface.

The Start Points are displayed as Green boxes on all vectors when this option is selected. Start Point on a vector can be moved using the Node Editing Tools. Select Node Editing cursor or press **N**. Place the cursor over the node to be used as the Start Point. Click Right mouse button and select **Make Start Point** (or press **p**) Remember, you can also insert a new point anywhere on a vector using the Right mouse menu or pressing the letter **p** - this will insert a new point and make it the start point.

**Note:** Selecting Use Start Point may result in less efficient toolpaths (increased cutting times) because it may take the machine longer to move between each shape being cut. If this option is not selected the software will try to calculate the shortest toolpath, minimizing the distance between link up moves. But the downside is that the cutter may plunge/mark important surfaces on the machined edge.

## Tabs (Bridges)

Tabs are added to open and closed vector shapes to hold parts in place when cutting them out of material.

### Add tabs to toolpath

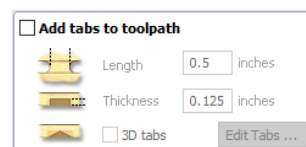

Checking ✓ the **Add tabs** option will activate tab creation for this toolpath. The Length and Thickness specify the size of each tab. Checking ✓ the **Create 3D Tabs** option will create 3D Tabs, the difference between this and 2D Tabs is described below.

## Create 3D Tabs

When this option is selected the tab will be triangular in section. This shape is created as the cutter ramps up to the specified Tab Thickness then down the other side. The 3D Tabs will often allow the machine to run quicker and smoother because it does not have to stop to move in Z at the start and end of each tab.

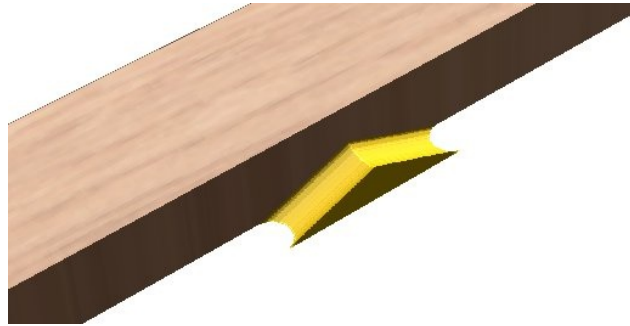

*3D Tabs option selected*

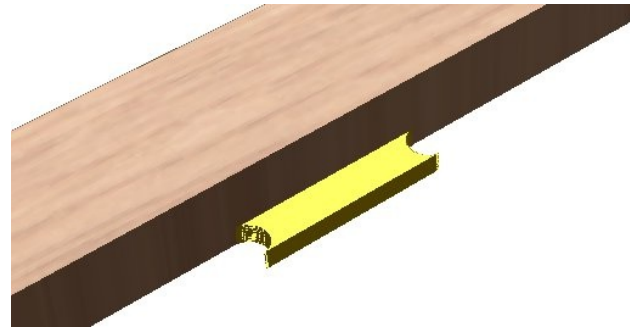

*3D Tabs option not selected*

If this option is unchecked, the 2D tabs will be used. The cutter stops at the start point for each tab, lifts vertically by the specified Thickness runs across the ramp, stops and plunges down the other side.

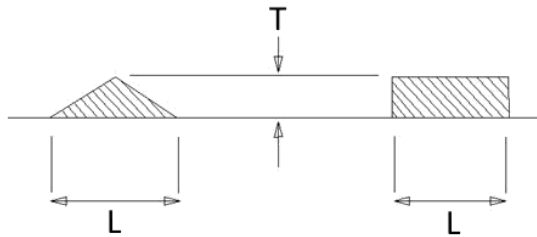

*This image shows how the Length and Thickness values are used when creating 3D and 2D tabs.*

## Edit Tabs

Clicking on the **Edit Tabs...** button automatically opens the 2D window and the Toolpath Tabs form is displayed:

### Add Tabs

#### Constant Number

Calculates the length of each selected vector and places 'X' number of equally spaced Tabs around the shape.

#### Constant Distance between tabs

This option places a tab at the specified distance around the selected shape.

If placing Tabs at the Distance around the shape results in fewer than the **Min. number**, the minimum number of Tabs are automatically equally placed on the shape.

If the number of tabs calculated using the Distance around the shape is

**Toolpath Tabs**

**Add Tabs**

Constant Number

Constant distance between tabs

Distance  inches

Min. number

Max. number

First tab at machining start point

---

**Interactive tab entry**

Add Tab - Click on a selected vector to insert a tab at the cursor position.

Delete Existing Tab - Click on it.

Move Tab - Click on it and drag it to the new position with the button pressed

Select or Deselect Vector - Press Shift key while clicking on the vector

greater than the specified **Max. number**, the maximum number are placed at equal distance around the shape.

## First tab at machining start point

If checked, ✓ a Tab will be placed at the start point (Green node) of a vector when the option First Tab at Machining Start Point is selected.

## Dynamically positioning tabs in the 2D View



Interactive Tab positioning is very easy. Simply place the cursor at the point where the Tab is required and click the Left mouse. To Move a Tab, Click and Drag with the Left mouse button on a Tab to move.

To Delete a Tab, place the cursor over an existing tab and click the left mouse button.

**Note:** The best place to put Tabs on a part is on the flat areas so they can easily be removed and tidied up.

The quickest method for adding Tabs to multiple shapes is to use the automatic option to add 'X' number. The position of these can then very easily be modified by clicking and dragging to move tabs to the 'best positions' and also delete unwanted tabs.

## Profile Options

The Profiling options section of the toolpath form contains five additional pages, each of which allows a particular set of Profile machining options to be specified. The precise number of option pages will depend on which Toolpath strategy you are currently using. The full range of option pages are:

- Ramps
- Leads
- Order
- Start At
- Corners

These help control ways to ensure the parts are held in place and machined as easily as possible while ensuring the highest quality edge finish.

Each set of options can be accessed by the tabs at the top of the Profile options section.

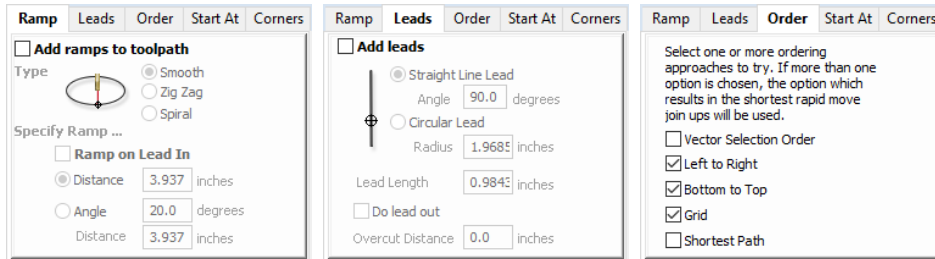

## Ramp

Ramp moves are used to prevent the cutter from plunging vertically into the material. The cutter gradually cuts at an angle dropping into the material significantly reducing cutter wear, heat build-up and also the load on the router spindle and Z axis of the machine. If multiple passes are required due to the Pass Depth being less than the Cut Depth, the ramp moves are applied at the start of each level. All ramp moves are performed at the plunge rate selected for the current tool.

## Smooth

This option creates a smooth ramp into the material using either the specified Distance or Angle.

When a Lead In distance has been specified, the option Ramp on Lead In disables the distance and angle options and automatically limits the ramp moves to only be on the lead in portion of the toolpath.

## Zig Zag

This option ramps into the material by Zig-Zag backwards and forwards using either the specified Distance or Angle and Distance.

The Distance option ramps into the material, zigging for the specified distance in one direction then zagging back over the same distance.

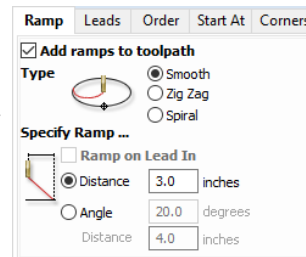

The Angle option is typically used for cutters that cannot plunge vertically but have an entry angle specified by the manufacturer.

## Spiral

Checking  this creates a continual spiral ramp, these are only available when the toolpath does not include lead in moves.

This option ramps into the material over the complete circumference of the profile pass. The angle is automatically calculated to ramp from the start point to full depth over the perimeter distance around the job.

The rate at which the cutter ramps into the material is determined by the Pass Depth specified for the cutter. For example, Spiral Profiling 0.5 inch deep with a cutter that has a Pass depth of 0.5 or greater will spiral down in 1 pass. Editing the Pass depth to be 0.25 inch results in the 2 spiral passes around the profile.

## Leads

Lead in / out moves can be added to profile toolpaths to help preventing marking the edges of components with dwell marks that are typically created when a cutter is plunged vertically on the edge of the job.

### Straight Line Lead

This option creates a linear lead onto the cutter path using the Angle and Lead length distance specified.

The toolpath will lead onto the selected edge at the specified Angle.

Checking  the **Do lead out** option results in an exit lead being added at the end of the toolpath off the machined edge.

The Overcut Distance forces the cutter to machine past the start point and is often used to help produce a better edge quality on parts.

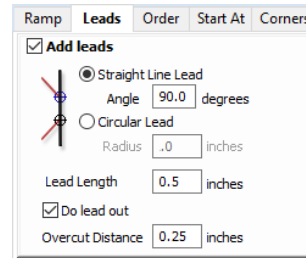

### Circular Lead

This option creates an arc lead onto the toolpath using the Radius and Lead length distance specified.

The toolpath will curve onto the selected edge, tangent to the direction of the vector at the point it reaches the actual geometry edge.

Checking  the **Do lead out** option results in an exit lead being added at the end of the toolpath off the machined edge.

The Overcut Distance forces the cutter to machine past the start point and is often used to help produce a better edge quality on parts.

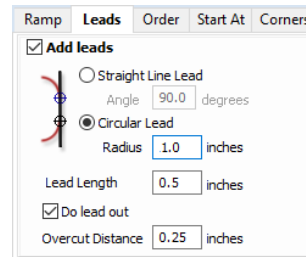

## Order

The order tab allows you to specify the approaches the program will use to determine the best order to cut your vectors. You can specify multiple options, in which case the program will calculate the result of using each option and select the one which results in the shortest machining time.

### Vector Selection Order

This option will machine the vector in the order in which you selected them. If you have vectors inside each other (like in the letter 'O'), the inner vector will always be machined before the outer one regardless of the selection order.

### Left to Right

This option will join up parts on the left of the material first and move across to the right.

### Bottom to Top

This option will join up parts on the bottom of the material first and move up to the top.

### Grid

This option will join use a grid based approach with the size of the grid based on the size of the parts. The algorithm will try to join up parts within a particular section of the grid before moving on.

### Shortest Path

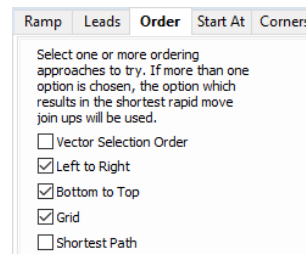



This option use a 'shortest path' algorithm to try and determine the shortest possible path. However, for large numbers of parts this requires an unfeasible amount of computing power so an approximation algorithm is used. Although very good, this algorithm cannot guarantee to produce the very shortest path, but in tests at Vectric, the results have been very good indeed. This option still takes a substantial amount of time on slow computers of for very large numbers of parts.

## Start At

### Keep Current Start Points

The start point of the vector will dictate the start of the toolpath.

### Optimize Start Points

The software will automatically attempt to optimize each profile start position based on speed of completing the job.

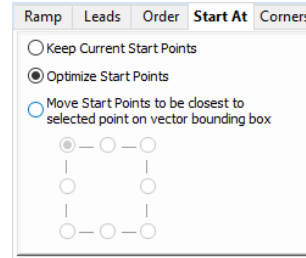

### Closest on Bounding Box

Influence the start point by defining which part of the bounding box of the profiled vector it should start near.

This will look for the nearest point, from all of the spans' endpoints, and will start the toolpath from that point.

## Corners

Choosing this tab and checking  the option **Sharp external corners** (see below) forces the cutter to machine around the shapes and retain any square corners.

### Sharp External Corners

This option makes adding beveled edges to a 2D shape very quick and easy, this can be a good way to turn simple 2D cut out lettering into a high quality signage products that look more interesting or provide a different option for customers.

This is an example of the type of effect that can be created by using this option:

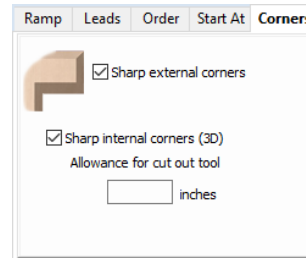

Standard Profile toolpaths without the Sharp Corners switched on roll around the sharp corners. This still give a point on a straight sided tool but will give a radiused edge when using a V-bit.

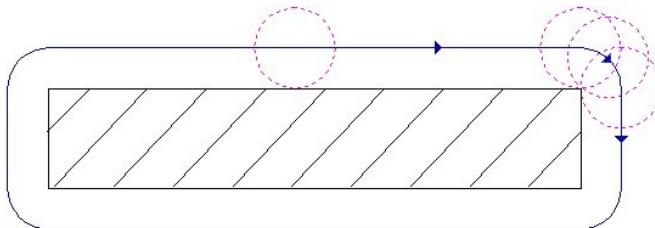

When Sharp External Corners is selected the following change is made to the toolpath (see image below) so it makes sharp external corners as shown in the image of the letter 'M' at the top of the page.

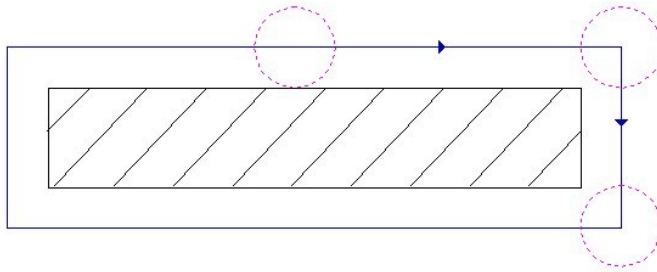

## Sharp Internal Corners

When Sharp Internal Corners is selected the *V-Bit* tool will raise up into internal corners to sharpen them with its point. The difference between checking  this and leaving it unchecked is shown in the two images below.

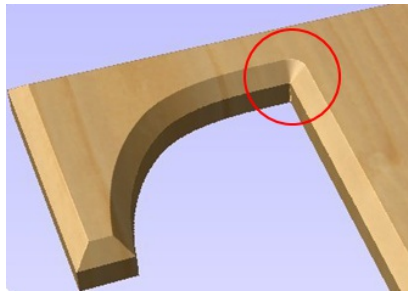

*Sharp Internal Corners not selected*

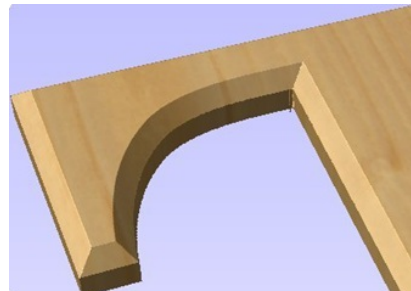

*Sharp internal corners selected*

## Allowance for Cut out tool

Sharp internal corners are often used when creating beveled letters. In this case, the letters usually have straight 'returns' which are machined with a straight sided end mill. The cut out pass for the end mill needs to be offset from the vector to allow for the bevel created by the tool. This field displays the value you will need to enter into the 'Allowance Offset' field when you create your cut out profile toolpath for the end mill. You can select the value with the mouse and used **Ctrl+C** to copy it to the clipboard and then copy it into the 'Allowance Offset' field when you create the cut out toolpath.

## Additional notes on Profile Machining

### Machining Open Vectors

The direction of open vector(s) is very important when using Profile strategies as this is used to determine which side of the selection is the right and left for machining. Selecting Node Edit mode (pressing **N** on the keyboard) will display a Green node at the start of the vector. Looking along the vector(s) from the green node indicates the direction and the image below shows offsets to the left and right of an open vector.

The Cut Direction - Conventional or Climb controls which end of the open vector the toolpath will start. Changing the cut direction will reverse the direction of cut.

Conventional starts cutting at the Start point Climb cutting starts cutting at the end point

In the following examples, the vector is the magenta dotted line and the arrowed line is the toolpath:



*Profiling the Left of the vector using Climb cutting.*



*Profiling the Left of the vector using Conventional cutting*

Talk to your material and tooling suppliers for details about what is most appropriate for your specific type of work.

Tabs can be added to open profile toolpaths Sharp External Corner options do not apply because identifying the outside / inside of an open shape is ambiguous. Leads cannot be added to open profile toolpaths. Ramps can be added to open

profile toolpath.

## Safe Z

The height above the job at which it is safe to move the cutter at rapid / max feed rate. This dimension can be changed by opening the Material Setup form.

Safe Z	0.2 inches
Home Position	X:0.00 Y:0.00 Z:0.80
Vector Selection:	Manual <input type="button" value="Selector ..."/>
Name:	Profile 4

## Home Position

Position from and to that the tool will travel before and after machining. This dimension can be changed by opening the Material Setup form.

## Vector Selection

This area of the toolpath page allows you to automatically select vectors to machine using the vector's properties or position. It is also the method by which you can create Toolpath Templates to re-use your toolpath settings on similar projects in the future. For more information, see the sections Vector Selector and Advanced Toolpath Templates.

## Name

The name of the toolpath can be entered or the default name can be used.

## Pocketing Toolpath



This option opens the Pocket Toolpath form for machining 2D pockets. These toolpaths automatically compensate for the tool geometry - both diameter and angle.

### Cutting Depths

#### Start Depth (D)

Specifies the depth at which the pocket toolpath is calculated. When cutting directly into the surface of a job the Start Depth will usually be 0. If machining into the bottom of an existing pocket or stepped region, the depth of the pocket / step must be entered.

#### Cut Depth (C)

The depth of the toolpath relative to the Start Depth.

## Tool

Clicking the  button opens the Tool Database from which the required tool can be selected. See the section on the Tool Database for more information on this.

Clicking the  button opens the Edit Tool form which allows the cutting parameters for the selected tool to be modified, without changing the master information in the database.

<b>Pocket Toolpath</b>	
<b>Cutting Depths</b>	
Start Depth (D)	<input type="text" value="0.0"/> inches
Cut Depth (C)	<input type="text" value="1.0"/> inches
<input checked="" type="checkbox"/> <b>Show advanced toolpath options</b>	
<b>Tool:</b> End Mill (0.125 inch)	
<input type="button" value="Select ..."/> <input type="button" value="Edit ..."/>	
<b>Passes:</b> 8	<input type="button" value="Edit Passes ..."/>
<input type="checkbox"/> <b>Use Larger Area Clearance Tool</b>	
Not using area clear tool	
<input type="button" value="Select ..."/> <input type="button" value="Edit ..."/>	
<b>Clear Pocket ...</b>	
<input checked="" type="radio"/> <b>Offset</b> <input type="radio"/> <b>Raster</b>	
Cut Direction	
<input checked="" type="radio"/> <b>Climb</b> <input type="radio"/> <b>Conventional</b>	
Raster Angle	<input type="text" value="0.0"/> degrees
Profile Pass	Last
Pocket Allowance	<input type="text" value="0.0"/> inches
<input type="checkbox"/> <b>Ramp Plunge Moves</b>	
Distance <input type="text" value="1.0"/> inches	
<input type="checkbox"/> <b>Use Vector Selection Order</b>	
Safe Z 0.2 inches	
Home Position X:0.00 Y:0.00 Z:0.80	
Vector Selection: Manual <input type="button" value="Selector ..."/>	
Name: <input type="text" value="Pocket 1"/>	
<input type="button" value="Calculate"/>	<input type="button" value="Close"/>

## Specify Pass Depths

The Pass Depths section at the top of the form shows a list of the current pass depths. The relative spacing of the passes is indicated in the diagram next to the list. Left click on a depth value in the list, or a depth line on the diagram, to select it. The currently selected pass is highlighted in red on the diagram.

To edit the depth of the selected pass, change the value in the Depth edit box and click **Apply**.

The **Delete** button will delete the selected pass.

The **Clear All Passes** button will delete all the passes.

To add a new pass, double left click at the approximate location in the passes diagram that you wish to add the pass. A new pass will be added and automatically selected. Edit the precise Depth value if required and then click **Apply**.

The Set Last Pass Thickness option will enable an edit box where you can specify the last pass in terms of the remaining thickness of material you wish to cut with the last pass (instead of in terms of its depth). This is often a more intuitive way to specify this value.

### Pass Depth List Utilities

This section of the form includes two methods for creating a set of passes in one go.

The first method sets the passes according to the Pass Depth property of the selected tool.

This is initially the default method used by Cut2D Desktop when it creates profile passes. The step size is varied to try and optimize the number of passes (see above) unless the **Maintain exact tool pass depth** option is checked ✓.

The second method creates evenly spaced passes according to the value entered in the **Number Of Passes** edit box.

To apply either method click the associated **Set Passes** button to create the resulting set of pass depths in the passes list and diagram.

**Warning:** Setting the number of passes with either of these utilities will discard any custom passes you may have added.

### Use Larger Area Clearance Tool

If this option is selected two tools are used to clear the pocket. A large tool to do the bulk of the area clearance and a smaller tool (the first tool selected) to remove the remaining material and do a final profile pass.

When a pocket toolpath is created, the Pass Depth value associated with the selected tool (part of the tool's description in the Tool Database) is used to determine the number of passes needed to pocket down to the specified Cut Depth. However, by default Cut2D Desktop will also modify the tool step down by up to 15%, if by doing so it is able to reduce the total number of passes required to reach the desired cut depth. It is usually desirable to benefit from the significantly reduced machining time of cutting pockets using less passes if possible.

Nevertheless, there are some occasions where the exact step downs for a given profile pass needs to be more precisely controlled - when cutting into laminated material, for example. The Passes section of the Pocket Toolpath page indicates how many passes will be created with the current settings. The **Edit Passes...** button will open a new dialog that enables the specific number and height of passes to be set directly.

### Clear Pocket

There are two choices of the type of fill pattern that will be used to clear away the area to be machined with the Pocket Toolpath, Offset and Raster.



**Offset**

Calculates an offset area clearance fill pattern to machine inside the selected vector(s). Options for Cut Direction to be either: Climb (CCW) cutting direction Conventional (CW) cutting direction.



**Raster**

Calculates a Raster based area clearance fill pattern to machine inside the selected vector(s). Cut Direction for the final pass to be either:

- Climb (CCW) cutting direction
- Conventional (CW) cutting direction

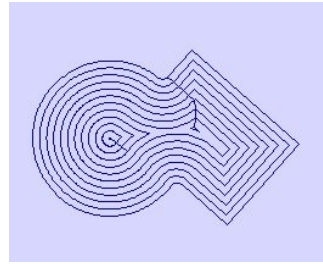

Clear Pocket - Offset Strategy

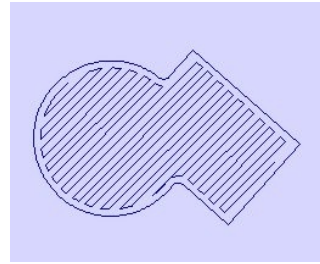

Clear Pocket - Raster Strategy

## Raster Angle

Between 0 and 90°, where 0° is parallel to the X axis and 90° parallel to the Y axis.

## Profile Pass

Used to clean up the inside edge after machining the pocket. This can be done either before the rastering (First) or after the rastering (Last). If 'No Profile Pass' is selected, you will need to calculate a profile pass manually to machine the pocket to size.

## Pocket Allowance

This option is used to leave material on the inside of the pocket for the Profile Pass to clean-up. This is often very useful for ensuring the cutter does not mark the edge surface of the pocket when roughing out.

A positive value in the allowance box will lead to an undercut of the selected closed vector. I.E. the pocket will be smaller than the chosen vector, by the specified value.

A negative value would result in an overcut of the selected closed vector. I.E. the pocket will be larger than the chosen vector, by the specified value.

**Note:** When the stepover for a pocket fill is greater than 50% of the cutter/tip diameter the software automatically adds 'Tail' moves to the corner regions on the toolpaths to ensure material is not left on the job. You can see these in the diagram of a star being pocket machined below:

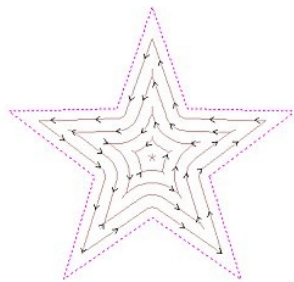

Offset larger than 50%

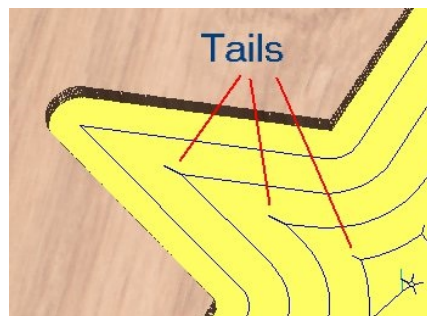

Tails to clean out corners

## Ramp Plunge Moves

The cutter can be ramped over a distance into the pocket instead of plunging vertically. This approach reduces heat build-up that damages the cutter and also reduces the load on the spindle and z axis bearings.

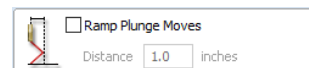

## Use Vector Selection Order

If this option is checked, ✓ pockets will be machined in the order you selected them. If the option is not checked the program will optimize the order to reduce machining time.

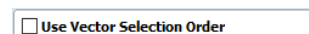

## Safe Z

The height above the job at which it is safe to move the cutter at rapid / max feed rate. This dimension can be changed by opening the Material Setup form.

Safe Z	0.2 inches
Home Position	X:0.00 Y:0.00 Z:0.80
Vector Selection:	Manual <input type="button" value="Selector ..."/>
Name:	<input type="text" value="Profile 4"/>

## Home Position

Position from and to that the tool will travel before and after machining. This dimension can be changed by opening the Material Setup form.

## Vector Selection

This area of the toolpath page allows you to automatically select vectors to machine using the vector's properties or position. It is also the method by which you can create Toolpath Templates to re-use your toolpath settings on similar projects in the future. For more information, see the sections Vector Selector and Advanced Toolpath Templates.

## Name

The name of the toolpath can be entered or the default name can be used.

## Drilling Toolpath



Drilling allows the centers of selected closed vectors to be drilled to a specified depth. The Tool Database includes an option to specify the Drill diameter and cutting parameters.

<b>Drilling Toolpath</b>	
<b>Cutting Depths</b>	
Start Depth (D)	<input type="text" value="0.0"/> inches
Cut Depth (C)	<input type="text" value="1.0"/> inches
<b>Tool: Drill (0.250")</b>	
<input type="button" value="Select ..."/> <input type="button" value="Edit ..."/>	
<input type="checkbox"/> <b>Use Peck Drilling</b>	
<input checked="" type="radio"/> Retract above the cutting start depth	
<input type="radio"/> Retract above the height of the previous pass	
Retract Gap (R)	<input type="text" value="0.0"/> inches
Peck Depth (P)	0.25 inches
Note: Peck depth is controlled by the 'Pass Depth' for the tool	
<input type="checkbox"/> <b>Dwell at the bottom of each drill pass</b>	
Dwell Time	<input type="text" value="0.0"/> seconds
<input type="checkbox"/> <b>Use Vector Selection Order</b>	
Safe Z 0.2 inches	
Home Position X:0.00 Y:0.00 Z:0.80	
Vector Selection: Manual <input type="button" value="Selector ..."/>	
Name: <input type="text" value="Drill 1"/>	
<input type="button" value="Calculate"/>	<input type="button" value="Close"/>

## Cutting Depths

### Start Depth (D)

This specifies the depth at which the toolpath is calculated from. When cutting directly into the surface of a job the **Start Depth** will often be 0. If machining into the bottom of an existing pocket or 3D region, the depth needs to be entered.

### Cut Depth (C)

The depth of the toolpath relative to the Start Depth.

## Tool

Clicking the  button opens the Tool Database from which the required tool can be selected. See the section on the Tool Database for more information on this. Clicking the  button opens the Edit Tool form which allows the cutting parameters for the selected tool to be modified, without changing the master information in the database.

## Peck Drilling

When the option **Use Peck Drilling** is selected, the drill will cut to the Pass Depth set in the Tool Database for the selected Drill. It will then retract to the **Retract Gap** according to the retract option selected (see below), before drilling to the next depth, incremented by an additional Pass Depth. This cycle is repeated until the hole is drilled to the required depth. The retract moves are used to remove any build-up of material from the hole to help with overheating and breakage. If the Pass Depth is greater than the required Cut Depth, the hole will be drilled in a single cycle. However, if a Cut Depth of 1 inch with a Pass Depth of 0.25 inch is used the hole will be drilled in 4 cycles.

### Retract above cutting start

This option will cause the tool to retract fully out of the drill hole after each peck drill plunge. This is beneficial for clearing swarf/chips completely from the drill hole during the drill cycle. With this option selected the Retract Gap value (R) is the fixed distance above the start cut depth. Thus the total retract and plunge distances for each peck drill cycle will increase as the hole deepens and this will generally result in longer machining times.

### Retract above the height of the previous pass

Instead of fully retracting out of the drill hole, it is also possible to retract to a height relative to the previous cut depth. This strategy typically requires a shorter set of plunges and retracts over the course of a peck drill toolpath because they will be

constant for each peck drill cycle, regardless of the drill hole depth. However, it will not necessarily clear swarf/chips completely from the drill hole. With this option selected the Retract Gap value (R) is the relative distance above the height of the previous peck drill pass.

## Dwell at the bottom of each drill pass

With this option checked, ✓ the **Dwell Time** value is used pause the drill at the bottom of each peck drill pass before retracting. The dwell time value is measured in seconds.

**Note:** To make use of this feature your Post-Processor must support the Dwell section and may require updating.

## Use Vector Selection Order

If this option is checked, ✓ pockets will be machined in the order you selected them. If the option is not checked the program will optimize the order to reduce machining time.

## Safe Z

The height above the job at which it is safe to move the cutter at rapid / max feed rate. This dimension can be changed by opening the Material Setup form.

Safe Z	0.2 inches
Home Position	X:0.00 Y:0.00 Z:0.80
Vector Selection:	Manual <input type="button" value="Selector ..."/>
Name:	Profile 4

## Home Position

Position from and to that the tool will travel before and after machining. This dimension can be changed by opening the Material Setup form.

## Vector Selection

This area of the toolpath page allows you to automatically select vectors to machine using the vector's properties or position. It is also the method by which you can create Toolpath Templates to re-use your toolpath settings on similar projects in the future. For more information, see the sections Vector Selector and Advanced Toolpath Templates.

## Name

The name of the toolpath can be entered or the default name can be used.

## Quick Engraving Toolpath



This form is used specifically for calculating engraving and marking toolpaths.

### Tool

Clicking the **Select** button opens the Tool Database from which the required tool can be selected. See the section on the Tool Database for more information on this. Clicking the Edit button opens the Edit Tool form which allows the cutting parameters for the selected tool to be modified, without changing the master information in the database.

### Depth / Pressure

When using Conventional Engraving and End Mill cutters the Depth to engrave / mark is specified and this z depth dimension is output in the toolpath file sent to the CNC machine. The 3D Preview of these toolpaths shows the specified depth of engraving.

When using a Diamond Drag marking Tool the Pressure setting is used to pre-load the spring to ensure the tip of the diamond stays in contact with the material surface, especially when marking uneven surfaces. The 3D Preview of the depth these toolpaths will mark using the Angle of the diamond and the Width of the Line.

For example, when using a 90° Diamond Drag Tool with a 0.010 inch Line Width specified. The depth shown in the 3D preview will be 0.005 inch (with 90° the depth = half the line width).

**Quick Engrave**

**Tool:** Diamond Drag (90 deg 0.3mm Line)

**Depth / Pressure**  inches

**Outline**  **Fill**

**Offset**  **Hatch**

**Stepover**  inches

**Hatch Angle**  degrees

**Cross Hatch**

**Use Nose Cone**

**Tool Depth**  inches  
**Number of Passes**

**Safe Z** 0.2362 inches  
**Home Position** X:0.00 Y:0.00 Z:4.08  
**Vector Selection:** Manual

**Name:**

Add side to toolpath name  
**Post Processor**  
 XYZ 4010 Arcs (inch) (\*.nc)   
 Output direct to machine  
**Driver:**



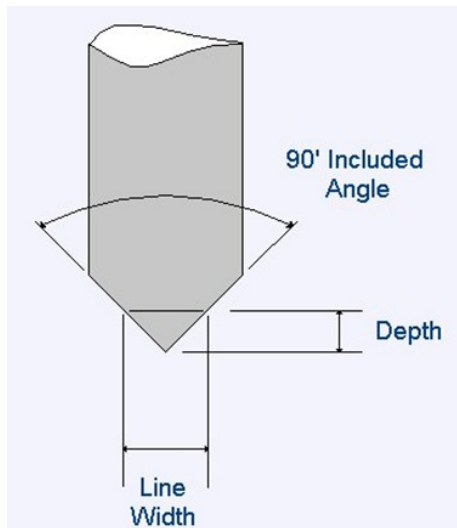

*Engraving Tool*

The ratio of Depth to Line Width will change when using diamond drag tools with different tip angles. When the option to use a Nose Cone is selected (see below) the actual depth specified on the form is used when previewing the toolpath in the 3D view.

### Strategy

When using the Quick Engraving Form the Stepper for the cutter is specified on the form and is NOT automatically set from the Tool Database.

The selected text or vectors can be Outlined or Filled.

### Outline

The tip of the cutter runs on the selected lines engraving / marking the material surface



*Example of outline engraving*

### Fill

A pattern is used to engrave / mark inside the selected text or vectors. There are 3 fill pattern options.



*Fill engraving with Offset pattern*

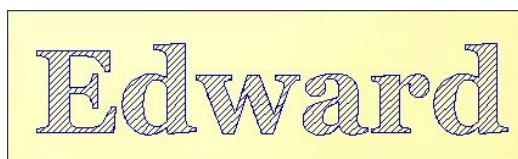

*Fill engraving with 45° Hatch pattern*





Fill engraving with Cross Hatch pattern.  
Cross Hatch Fill pattern engraves 2 sets of lines, with the second set at 90° to the angle specified.

### Use Nose Cone

A nose cone is often used when engraving or marking material that is not flat. The nose cone is spring loaded forcing it to slide on the surface of the material. The engraving cutter is set to extend / protrude out of the bottom of the nose cone by the depth of engraving / marking required. This is typically set at around 0.010 inches to 0.020 inches.

When the option to use a Nose Cone is selected the actual depth specified on this region of form is used when previewing the toolpath in the 3D view.

### Number of Passes

This option runs the cutter multiple times divides over the toolpath pattern.

### Output Options

Select the appropriate postprocessor and Save the Toolpath ready to send to the CNC machine, similar to the Save Toolpath form.

If your machine can be driven using a Windows Printer driver (Roland and Gravograph / New Hermes machines use this technique) it may be possible to select the installed printer driver and output toolpaths directly from the software instead of saving an intermediate file.

Checking  the option '**Output direct to machine**' enables the Device option which is used to setup the appropriate windows printer driver.

## Inlay Toolpath



The Inlay toolpath functionality can be used to calculate either profile or pocketing toolpaths with automatic compensation for the tool radius; this allows the cut-out parts to fit into the corresponding cavities. This is a great feature for creating decorative woodwork and is also particularly useful for sign makers for creating inlaid letters and graphics.

### How Inlays work

When using a CNC machine to cut out shapes then the tool will always leave a radius on any internal corner. When cutting holes or pockets the tool conversely leaves a radius on the external corners. If no changes are made to accommodate this then there would be no way to fit one part into the other. This is shown highlighted on the letter 'T' shown in the image below. On the left you can see the internal corners with a radius on the part being cut out (highlighted with red ovals). On the right you can see the radiused external corners on the hole (highlighted with green ovals). As you can envisage trying to slot the 'T' into the hole would not work as it is the proverbial square peg in a round hole!

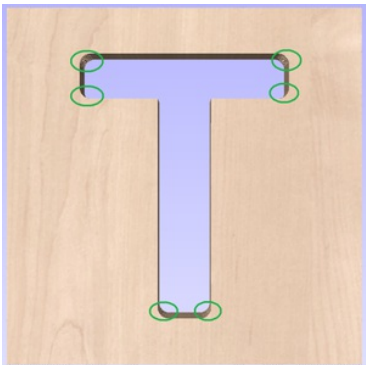
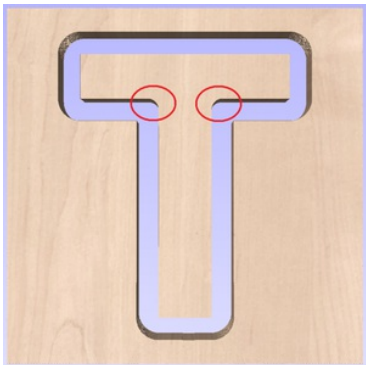
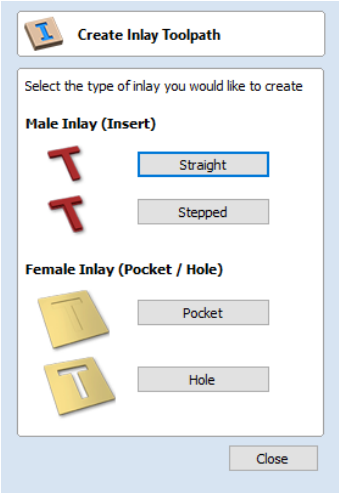

It is not possible to avoid the added radius as it is formed by the tool size and shape. The Inlay function though, will create toolpaths which take the tool radius into account and compensate for it by rounding off the sharp corners so the resulting parts will fit together. This can be seen in the images shown below where the same letter has been cut using the Inlay toolpaths, you can see all corners (internal and external) now have the same radius so they will slot together.

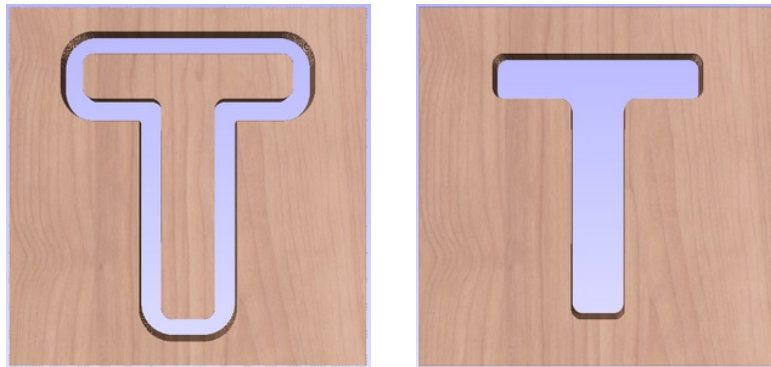

When creating an Inlay toolpath the radius is automatically compensated for, so it is very important to make sure you specify the same tool for both parts of any inlay (male and female). If you do not do this the Inlay will not fit together.

If creating a Pocket then the main Tool (the finish tool) not the larger (clearance) tool should be the same as the one as used for creating the Male Inlay.

**Note:** You must use the same tool for both parts of an inlay for the resulting parts to fit together correctly.

## Male Inlay (Insert)

### Straight

This option is for cutting out straight sided parts to act as the inserted piece of the inlay. It uses a variation on the Profile toolpath which will automatically round the external corners of the part to allow for the radius of the tool being used. All the standard Profile options are available in this form except there is no option to Profile Inside or On as this does not apply to this inlay type as it has to cut outside of the vector. The other standard options not available are the ability to add sharp Corners or set a Last Pass as again these would not apply to this application. The image below shows how the external corners are rounded based on the tool radius being used.

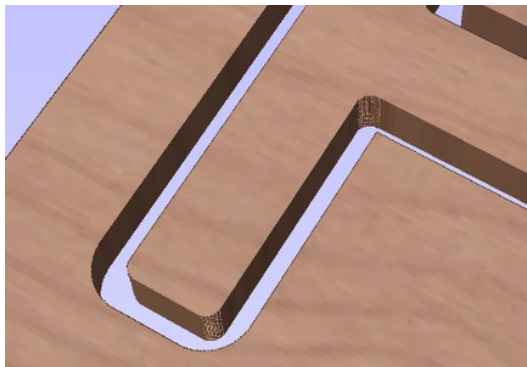

### Stepped

This option is for cutting out stepped sided parts to act as the inserted piece of the inlay. This style of inlay is typically used for what are referred to as 'Push Through' letters and shapes. These are parts which are inserted from the back and use the step as a shelf to invisibly mount them to the back of a sign. As with the Straight Inlay option it uses a variation on the Profile toolpath with the addition of the ability to specify a Step Depth and Step Width.

As the diagram shows in the form, the Step Depth is the vertical height of the step from the Start Depth down, the Step Width is how far from the edge of the original vector the part will be cut out (creating the step).

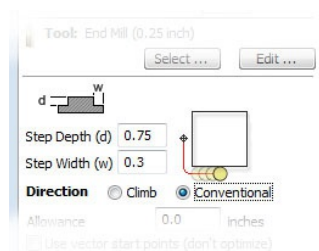



The image shown above shows a Stepped Male Inlay created in 1 inch thick material with a 0.75 inch Step Depth and a 0.3 inch Step Width.

All the other standard Profile options are available for Stepped Inlays except there is no option to Profile Inside or On as this does not apply to this inlay type and this option does not allow the use of either the Corner, Lead or Last Pass functions as these are also inapplicable to this type of toolpath.

**Note:** It is very important when working with Stepped Inlays that you allow enough space in between the shapes you are cutting out for the Step Width to be added. If the parts are too close then they will not be cut-out and the steps will not be properly formed.

## Female Inlay (Pocket / Hole)

### Pocket

This option is selected for cutting out a Pocket to act as the cavity for the corresponding Male shape to inlay into. It uses the same options as the standard Pocket style toolpath including the new option where you can use a larger and smaller tool to clear the pocket (smaller tool size should match that used for the Male Inlay). In order to make it work as an inlay pocket any internal corners will be rounded based on the tool radius to allow the male parts to fit into them (shown in the image below).

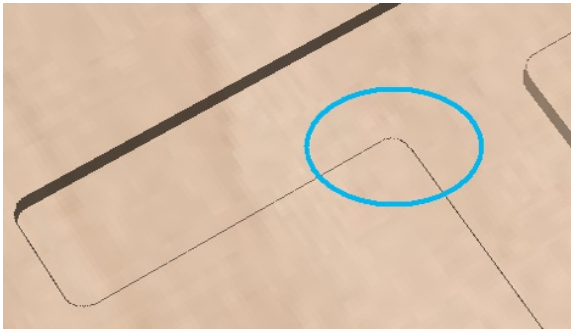

As has been previously discussed it is common to leave an allowance on one or both sides of the inlay, typically when working with letters the allowance would be left on the Pocket so the size and shape of the lettering itself is not affected any more than necessary.

### Hole

This option is for cutting out a Hole to act as the cavity for the corresponding Male shape to inlay through. The standard Profile options are available for Female Hole Inlays except there is no option to Profile Outside or On as this does not apply to this toolpath type and this option does not allow the use of the Corner options or Last Pass as these are also inapplicable to this type of toolpath. In order to make it work as an inlay, any internal corners will be rounded based on the tool radius to allow the male parts to fit into them (shown in the image below).

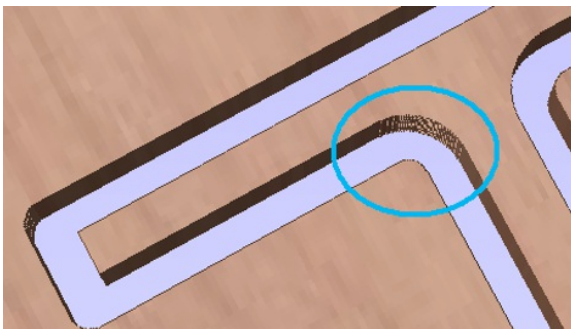

## Setting Inlay Allowances

Although the radius of the tool is compensated for when using the inlay tool, this in itself will almost always not be enough to ensure the two parts will fit together correctly. The parts will be exactly the same size and so would not fit together without a lot of force which would damage the part or without some kind of post-CNC hand work. Cutting the parts exactly the same size also does not allow for any kind of finish to be applied to either side.

To enable the parts to fit extra material either needs to be cut from the Male side, the Female side or in some applications both. This additional distance is added using the option in the toolpath form to add an Allowance. On the toolpaths which are based on a Profile then this is done with the Allowance Offset (Shown in the image below left - highlighted in red). For Pocket style toolpaths use the Pocket Allowance, (shown in the image below right highlighted in red). When a value is entered it will overcut the selected shape by this distance, this will reduce the size for male parts and increase the hole/pocket for female parts.

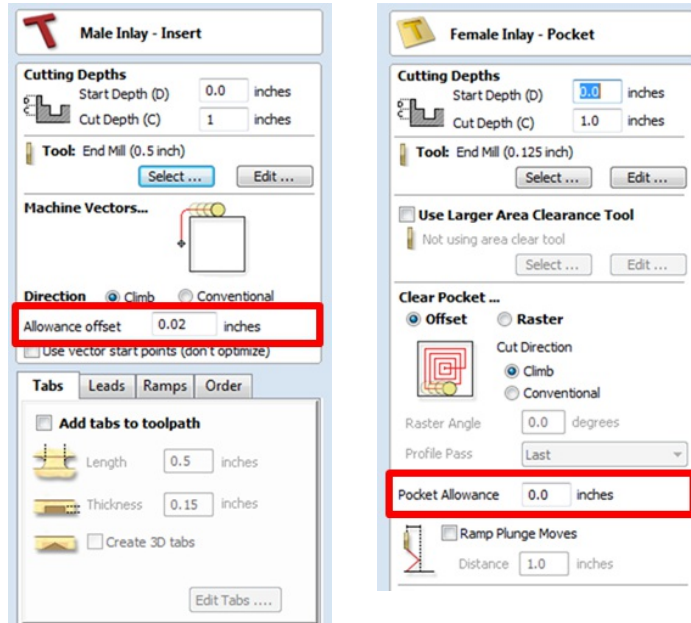

The size of the Allowance required will depend on the type of material (how much it may expand or contract between being cut and inlaid), the accuracy of your tooling, the accuracy of your machine and finally any finish you are planning to add to the finished parts (such as paint or varnish which will have a thickness). In most situations where no finish is being applied before the parts are inlaid then an allowance of 0.01 inches (0.25mm) or 0.02 inches (0.5mm) will be sufficient. If you are not sure what value to use then you should experiment with this on a test part to get the correct sizes for your particular setup and application.

In the majority of cases the Allowance is applied to the Female side of the inlay as it is typical to not want to alter the actual vector shapes (the Male side) any more than is required for the tool radius. This means the Hole or Pocket will be cut oversized to provide the additional allowance for the parts to fit.

## Safe Z

The height above the job at which it is safe to move the cutter at rapid / max feed rate. This dimension can be changed by opening the Material Setup form.

Safe Z	0.2 inches
Home Position	X:0.00 Y:0.00 Z:0.80
Vector Selection:	Manual <input type="button" value="Selector ..."/>
Name:	Profile 4

## Home Position

Position from and to that the tool will travel before and after machining. This dimension can be changed by opening the Material Setup form.

## Vector Selection

This area of the toolpath page allows you to automatically select vectors to machine using the vector's properties or position. It is also the method by which you can create Toolpath Templates to re-use your toolpath settings on similar projects in the future. For more information, see the sections Vector Selector and Advanced Toolpath Templates.

## Name

The name of the toolpath can be entered or the default name can be used.

# Laser Toolpaths

The Laser toolpaths section of the Toolpath Operations icons can be found on the Toolpaths tab, underneath the Toolpath list. These strategies are used to control a laser cutting head.



Laser Cut & Fill



Laser Picture

**Note:** The Laser Cut - Fill Form is only available with Laser Module

## Laser Cut - Fill



Laser Cut - Fill is used for cutting out shapes or marking areas.

Cut-outs can take into account the kerf, or width, of the laser beam to maintain the precise internal or external size the selected vector shapes. Shapes can also be filled with stripes or hatching to create simple shading effects.

The fields on the form are as follows.

### Settings

### Select

This button opens your database of previously stored laser settings for different jobs and materials. When a setting is selected from the database it will be used to populate the key fields in this section. You can subsequently modify these values when calculating the laser toolpath. Modifying the settings on this form will not alter the original stored settings within your database.

### Power

This value sets what proportion of your machines maximum laser power will be used for this toolpath.

### Move Speed

This specifies the maximum speed that your machine will move during cutting or engraving moves. The units are determined by the database setting that was originally selected.

### No. Passes

The machine can repeat a toolpath a number of times to cut through thicker material. This value sets the number of repeats.

### Strategy

Based on the selected vector shapes in your drawing, this toolpath offers four distinct strategies

- **Cut Outside / Right** - Selecting this option will run the laser around the outside of your selected vector shapes (or along their right-hand edge, if they are open vectors). The actual path of the laser is automatically offset from the original shape according to the kerf width of the laser. As a result, the external dimensions of the resulting physical part precisely match the size of the original vector drawing. This strategy should be used for cutting out shapes to precisely the correct dimensions.
- **Cut Inside / Left** - This option will run the laser around the inside (or left-hand edge) of your selected vector shapes, allowing for the kerf of the laser. This strategy is typically used for cutting holes, slots or sockets where the remaining recess has precisely the same dimensions as the original selected vector drawing.
- **Cut On** - This option will runs the center of the laser beam along the selected vector. No offsetting or kerf compensation is required.
- **Hatch Fill** - This is a marking or 'shading' strategy which profiles along the selected vectors and then fills-in the

shapes with stripes. When this option is selected the additional *Stepover*, *Hatch Angle* and *Cross Hatch* options will also become enabled - see below for more information on these.

## Allowance

This setting allows you to add an additional offset for the *Cut Outside*, *Cut Inside* strategies without adjusting the laser kerf settings and can be useful for easing or tightening the fit of shapes resulting from these cuts.

**Note:** This option is not applicable to the *Cut On* or *Hatch Fill* strategies and will be disabled if they are selected.

## Stepover

When creating hatch fills, this option determines the spacing between the hatch lines. It is only available when the *Hatch Fill* strategy is selected.

## Hatch Angle

When the *Hatch Fill* strategy is selected, this option determines the angle of the hatching lines used.

## Cross Hatch

Checking this option will create a cross hatch fill instead of a single set of lines.

**Note:** These options are only applicable to the *Hatch Fill* strategy and will be disabled if it is not selected.

## Toolpath Calculate

### Safe Z

The height above the job at which it is safe to move the cutter at rapid / max feed rate. This dimension can be changed by opening the Material Setup form.

Safe Z 1.8937 inches  
Home Position X:0.00 Y:0.00 Z:2.29

Name: Laser Cut 1

### Home Position

Position from and to that the tool will travel before and after machining. This dimension can be changed by opening the Material Setup form.

### Name

Enter a meaningful name for the toolpath here. It will be stored in the toolpath list using this name.

### Calculate

Clicking this button will initiate the process of calculating the toolpath using the form settings and adding the resulting toolpath to the toolpath list.

## Immediate Output

Once calculated, your toolpath is stored in the central Toolpath List and can be saved, edited or output to your laser machine at anytime using the Save Toolpaths command. In addition though, this form also includes a convenient Immediate Output section that allows you to save or send the most recently calculated toolpath directly from this form without having to close it (see VTransfer for more information).

**Post Processor**

Grbl (mm) (\*.gcode) ▾

Add side to toolpath name

Output direct to machine

Driver: vTransfer

Save Toolpath(s) ...

### Post Processor

Use this drop-down list to select the post-processor for your machine.

### Add side to toolpath name

If you are creating aligned toolpaths for a two-sided part, this option automatically adds the side name to the toolpath name as it is saved or exported to help keep your toolpaths organised.

### Output direct to machine

If your post-processor supports direct access to your cnc machine (including machines supported by VTransfer), this option will be available. Selecting this option will bypass saving the toolpath to disk and instead send it straight to the direct output driver.

**Note:** The Laser Picture Form is only available with Laser Module

## Laser Picture



The Laser Picture toolpath uses the laser to etch a copy of the selected bitmap picture into the surface of your material.

### Preparing the bitmap

This strategy requires a source bitmap image or photograph to be selected in the 2D View. It will be converted into a laser toolpath by creating a dense stripe, or hatch, pattern over the image and then adjusting the power of the laser as it moves across the image to reproduce it using lighter and darker marks. The precise tonal range and contrast of the final part will be the result of an interaction between the original colors or shades in the bitmap, the way in which the material burns as well as the power and speed of the laser. For these reasons some experimentation may be required to find the best settings for a particular job.

Your source bitmap can be edited in a number of ways before using this form to create your laser toolpath. You can use the Crop Bitmap command to trim a bitmap to a vector outline. This will allow you to remove any parts of a bitmap that you do not require.

The Picture Edit tool can also be used prior to creating the toolpath in order to adjust many important aspects of your image - such as brightness and contrast. In addition it can be used to add a feathered border the image. For the best results you should use this tool to highlight and accentuate out the important details of your image before creating your toolpath.

The fields on the form are as follows.

### Settings

This section details the laser settings for this toolpath. The **Select...** button will open the laser

tool database where you can

retrieve previously stored settings for a particular job or material. For convenience, these settings can also be modified in-situ on this toolpath form. Any edits you make directly on the form will only effect the current toolpath - they will not effect the stored settings in the database.

#### Max Power

This specifies the maximum power (as a percentage of the laser's maximum full power) that will be used for the darkest areas of the image.

#### Min Power

This specifies the minimum power (as a percentage of the laser's maximum full power) that will be used for the lightest areas of the image.

#### Move Speed

This setting allows you to locally override the move speed (or feed rate) of the cutting moves of your laser. For a fixed power the slower the laser moves, the darker the mark it will make. If you are already using maximum power but the image to still too light you may wish to slow the movement of the machine and burn for longer.

The screenshot shows the 'Laser Picture' toolpath form. It includes a 'Tool' dropdown set to 'Cut-Through 2mm' with 'Select ...' and 'Edit ...' buttons. Below are input fields for 'Max Power' (100.0%), 'Min Power' (0.0%), and 'Move Speed' (10.0 mm/sec). A 'Line Spacing' slider is set to 0.0059, and a 'Line Angle' slider is set to 0.0. The 'Post Processor' dropdown is set to 'Grbl (mm) (\*.gcode)'. There are checkboxes for 'Add side to toolpath name' and 'Output direct to machine'. A 'Driver: VTransfer' label is present. A 'Save Toolpath(s) ...' button is at the bottom. A 'Calculate' button is also visible above the 'Post Processor' section. A 'Close' button is at the very bottom right.

This is a close-up of the 'Settings' section. It shows the 'Tool' dropdown set to 'Cut-Through 2mm' with 'Select ...' and 'Edit ...' buttons. Below are input fields for 'Max Power' (100.0%), 'Min Power' (0.0%), and 'Move Speed' (10.0 mm/sec).



## Strategy Settings

### Raster

Selecting this option will generate a single set of parallel lines, or stripes, across your selected image.

### Hatch

This option will create *two* sets of parallel lines at 90 degrees from one another. This strategy will generally produce a denser image reproduction, but will typically take twice as long to etch.

### Selected

This option will use the selected vectors as the pattern for the toolpath moves. These may be generated using any method of creating vectors, such as the Vector Texture Tool

### Dither Image

With this option *un-checked*, laser power will be changed evenly in response to the lighter and darker areas of your image. Thus your image is reproduced by a range of burnt tones onto the surface of your material using continuously varying laser power. For some materials, however, the burning process tends to produce only two tones - burnt or unburnt - rendering this graduated approach ineffective. For materials with this property an alternative strategy can be used to generate the tonal range using only black dot patterns of differing densities instead - much like old newspaper picture print. This process is called *dithering* and it can be enabled using this option. In general you should only use this option if the material properties prevent you from using the higher quality true grayscale method.

**Note:** Selecting this option will disable some incompatible options on the rest of the form.

### Line Spacing

This slider adjusts the gap between the raster stripes - tight striping produces a denser image reproduction, but will take a lot longer to etch. The maximum density is set by the Kerf of your laser beam and the most sparse setting is 30 times this value.

### Line Angle

Adjust this slider to change the angle of the stripes or hatching used to etch the image. Zero degrees will produce horizontal stripes and ninety degrees, vertical.

## Toolpath Calculate

### Safe Z

The height above the job at which it is safe to move the cutter at rapid / max feed rate. This dimension can be changed by opening the Material Setup form.

### Home Position

Position from and to that the tool will travel before and after machining. This dimension can be changed by opening the Material Setup form.

### Name

Enter a meaningful name here before calculating the toolpath - this is the name under which your toolpath will appear in the toolpath list.

### Calculate

Clicking this button will initiate the process of calculating the toolpath using the form settings and adding the resulting toolpath to the toolpath list.

The screenshot shows the Strategy Settings form with the following elements:

- Three radio buttons: **Raster** (selected), **Hatch**, and **Selected Vectors**.
- A checkbox for **Dither Image**, which is currently unchecked.
- A **Line Spacing** slider ranging from **Sparse** to **Dense**, with a numerical input field set to **0.0059**.
- A **Line Angle** slider ranging from **-90°** to **90°**, with a numerical input field set to **0.0**.

The screenshot shows the Toolpath Calculate form with the following fields:

- Safe Z**: 1.8937 inches
- Home Position**: X:0.00 Y:0.00 Z:2.29
- Name**: Laser Picture 1



## Immediate Output

Once calculated, your toolpath is stored in the central Toolpath List and can be saved, edited or output to your laser machine at anytime using the Save Toolpaths command. In addition though, this form also includes a convenient Immediate Output section that allows you to save or send the most recently calculated toolpath directly from this form without having to close it (see VTransfer for more information).

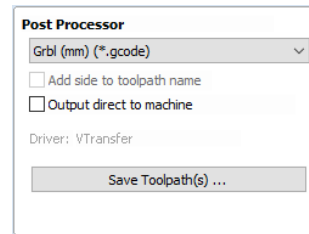

## Post Processor

Use this drop-down list to select the post-processor for your machine.

### Add side to toolpath name

If you are creating aligned toolpaths for a two-sided part, this option automatically adds the side name to the toolpath name as it is saved or exported to help keep your toolpaths organised.

### Output direct to machine

If your post-processor supports direct access to your cnc machine (including machines supported by VTransfer), this option will be available. Selecting this option will bypass saving the toolpath to disk and instead send it straight to the direct output driver.

## Laser Module

**The Laser Module extends the functionality of VCarve or Aspire and is currently only available to selected BETA testers while in development. This documentation is provided to support this testing process and this notice will be removed once the module is available for purchase.**

**Please note: The Laser Module has been created and tested for use with OptLaser or J-Tech laser retrofit kits on Shapoko and X-Carve CNC machines using GRBL controllers - other machines, lasers or controllers cannot be supported at this time.**

The Laser Module is a paid add-on for Cut2D Desktop which adds the following additional functionality:

- The ability to create Laser Cut and Fill Toolpaths
- The ability to create Laser Picture Toolpaths
- The ability to simulate a Laser Toolpath



### The Laser Cut - Fill Toolpath

Laser Cut - Fill Toolpath is used for cutting out shapes or marking areas.

Cut-outs can take into account the kerf, or width, of the laser beam to maintain the precise internal or external size the selected vector shapes. Shapes can also be filled with stripes or hatching to create simple shading effects.



### The Laser Picture Toolpath

The Laser Picture toolpath uses the laser and through varying the power of the laser etches a copy of the selected bitmap onto the surface of your material.

## Simulating Laser Toolpaths

Like all other toolpaths the laser toolpaths can be simulated. However, in the case of laser toolpaths, the simulation does not remove any material but instead marks the surface of the current simulation model. This marking is meant to simulate the charring of the material when scorched by the laser.

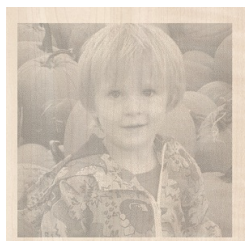

*Burn Rate 50*

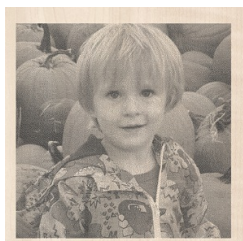

*Burn Rate 100*

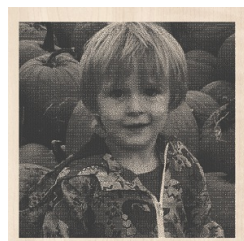

*Burn Rate 200*

Due to the many combinations of laser, power, material and feed rate, it will be necessary to calibrate the simulation so that the simulation output matches the real-world results. This calibration can be done by modifying the Maximum Burn Rate property of a given tool. This is the maximum speed at which the tool, when at 100% power, will still burn the material. This means that a greater value will result in the simulated toolpath appearing darker. This value can be set in the Tool Database. We suggest you cut a sample file with the material and power settings that you would typically use and then adjust the Maximum Burn Rate so that the simulation matches your achieved results.

## Vector Selector

This tool allows you to easily select vectors which meet a set of criteria, such as open, closed, circular and also matching constraints based on layers. The dialog can be accessed from the **Edit ► Vector Selector** menu item, or from the **Selector...** button on each toolpath form. When the command is executed the dialog shown is displayed.

The dialog is used to configure a set of 'filters' that determine which vectors will be selected. A filter is enabled by clicking on its check box, or selecting a 'radio button' option, the current selection will be updated with all the objects in the file which match the current filter options.

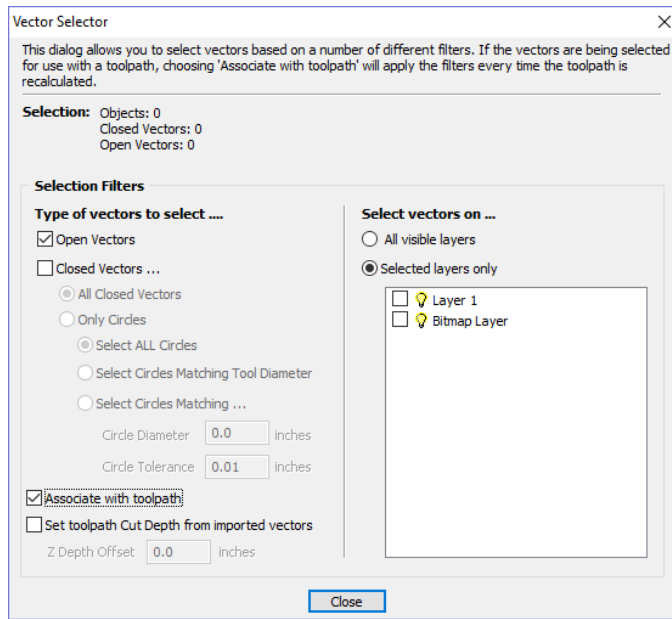

Generally you will start at the top of the dialog and work downwards, specifying more and more explicit filters to determine the required selection exactly.

The simplest option is just to use the form to *Select Closed Vectors* in the job or *Select Open vectors* (you can specify both, in which case all vectors will be selected as long as they are on a visible layer).

The most common way to use the **Vector Selector** is to select all the vectors on a given layer as shown in the screenshot of the dialog below.

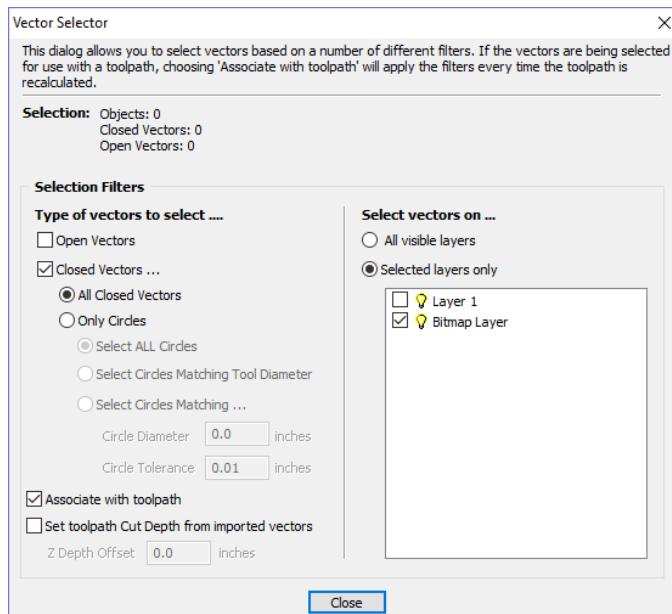

In this example, the dialog has been used to select *All Closed Vectors* on the layer with the name *Pocket*.

**Note:** When opened from **Edit ► Vector Selector**, the options *Associate with toolpath* and *Set toolpath Cut Depth from imported vectors* are not available. These options are only usable when applying the vector selector from a toolpath form.

## Selection

The Selection: section at the top of the dialog is continuously updated to show the results of the current filter and the 2D view is also updated to show what is currently selected. The *Objects:* entry shows the total number of objects selected, if these objects include Text or Groups, this number may be less than the total of *Closed* and *Open* vectors displayed on the following line. For instance, a block of text is one object but will usually consist of many closed vectors. If a group contains both open and closed vectors, it will be selected as matching both *Open* and *Closed* filters.

## Geometry Filters

The Geometry Filters section is used to specify constraints on the type of vectors to select. You can choose to select open vectors and/or closed vectors. Instead of selecting *All Closed Vectors*, the dialog can be used to select *Only Circles* and can even be used to specify an exact diameter and tolerance for the circles to be selected. This can be very useful for selecting vectors for drilling toolpaths, particularly if the vectors have not already been sorted into layers.

## Layer Filter

The Layer Filter section allows you to pick one or more visible layers on which to select vectors which match the geometry filter. Alternatively, the *All visible layers* option disables the filtering by layer and selects all vectors which match the geometry filter regardless of the layer they are on, as long as that layer is visible.

The *Associate with toolpath* option will be explained in the next section.

## Advanced Toolpath Templates

By associating a template with the result of a Vector Selector filter, we can make a template to automatically select the vectors it is intended to machine. A simple case would be to create a template which consisted of a Pocketing toolpath set up to machine all closed vectors on a layer called Pocket. After loading this template into a new job and choosing **Toolpaths ► Recalculate All Toolpaths**, the toolpath would be recalculated automatically selecting all closed vectors on the layer called Pocket.

The advanced templates are created by selecting the vectors for a toolpath using the **Selector...** button on the toolpath form. When a toolpath form is first opened, the **Vector Selection**: section on the form will show that vectors are being selected manually as shown below...

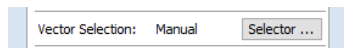

Pressing the **Selector...** button will display the **Vector Selector** form as shown previously. After making your geometry selection and before you close the form, select the *Associate with toolpath* option on the form as shown below.

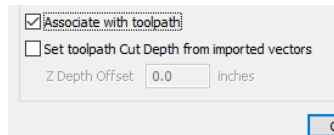

After the **Vector Selector** form closes, the Toolpath form will indicate that Vector Selection is now 'Automatic' as shown below...

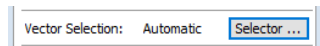

**IMPORTANT:** Calculate the toolpath to apply the changes you have made.

When you re-calculate or edit a toolpath that has the **Vector Selection** mode set to automatic, the vectors which match the filter when the toolpath is re-calculated or edited will be selected. To cancel the *Automatic* vector selection mode, you can just select the vectors to machine normally with the mouse, or use the **Selector...** button to bring up the **Vector Selector** dialog again (the settings are remembered) and uncheck the *Associate with toolpath* option.

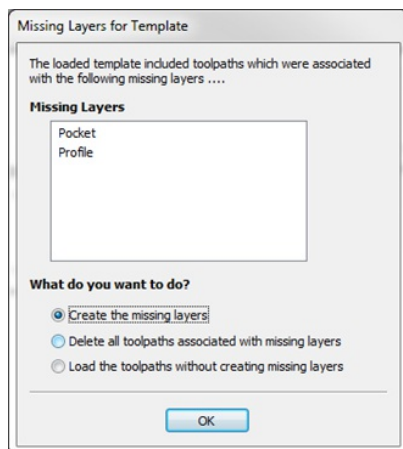

If toolpaths with the **Vector Selection** mode set to *Automatic* are saved as templates, these settings are saved with the template. When the template is re-opened and the toolpaths recalculated, they will automatically select all vectors which match the filters specified with the **Vector Selector** for that toolpath.

If you load a toolpath template which has toolpaths associated with layers which don't exist in the current file, the **Missing Layers for Template** dialog will be displayed. It lists all the missing layers and offers you the choice of having them created automatically, deleting toolpaths associated with missing layers or just loading the toolpaths as is.

Choosing to allow the dialog to automatically create the missing layers allows a toolpath template to be used to create 'standard' layers for machining operations and load the toolpaths ready to be calculated. All you then need to do is move vectors to the appropriate layers and recalculate all the toolpaths.

Choosing the *Delete all toolpaths associated with missing layers* option allows you to create a single template with many toolpaths and have the ones which aren't appropriate to the current job automatically deleted.

# Toolpath Editing Tools



The Tool Database



Edit Toolpath



Duplicate Toolpath



Delete Toolpath



Recalculate All Toolpaths

## Edit Toolpath



This option is used to modify an existing toolpath. Click to select a toolpath in the list then click the edit option to open the form.

The vectors associated with each toolpath are automatically remembered, so editing a toolpath will automatically select the vectors in the 2D window.

Make the required changes to the toolpath parameters. Click the Calculate button to update the toolpath.

A toolpath can also be edited by double-clicking on its name in the toolpath list.

## Duplicate Toolpath



The Duplicate Toolpath option creates and adds a copy of the selected toolpath to the Toolpath List. An index number is automatically added to the name of the new toolpath. For example:

Cut out - 1/4 inch End Mill will create a copy with the name Cut out - 1/4 inch End Mill (1)

Copying externally generated 3D toolpaths (as, for example, from PhotoVCarve) will also create a duplicate grayscale thumbnail image in the 2D View, which can then be used to position the toolpath within your job.

## Delete Toolpath



This tool is used to delete calculated toolpaths from the Toolpath List. Simply select the toolpath to be deleted and click the Delete Toolpath button to remove it.

Alternatively you can delete one or multiple toolpaths in the Toolpath List by right mouse clicking on a toolpath. Then from the drop-down menu click on the **Delete** option. This will present the options as shown in the image: Delete This, Delete All Invisible, Delete All Visible, Delete All.

**Delete This** will delete just the toolpath whose name you right mouse clicked on.

**Delete All Invisible** will delete any toolpaths in your Toolpath List that do not have a check-mark ✓ next to their name and are therefore currently not visible in the 2D or 3D Views.

**Delete All Visible** will delete any toolpaths in your Toolpath List that have a check-mark ✓ next to their name and are therefore currently visible in the 2D or 3D Views.

**Delete All** will delete all the toolpaths in your Toolpath List.

If you have incorrectly deleted a toolpath (or multiple toolpaths) then you have the option to Undo the toolpath(s) deletion via the **Undo** command on the **Edit** drop-down menu, the Undo icon on the Drawing Tab or the Undo shortcut key combination Ctrl + Z.

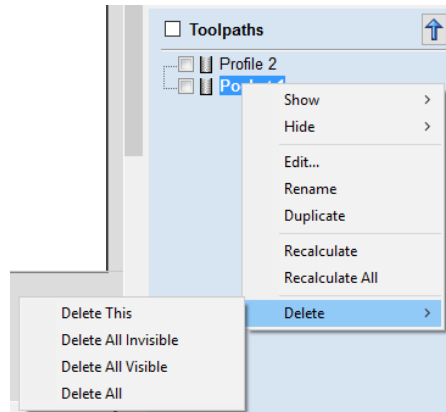

## Recalculate All Toolpaths



This command forces a recalculation of all the toolpaths in the Toolpath list. It is useful when the artwork used by the toolpaths has been modified, or the material block settings have changed.

# The Tool Database



The Tool Database is used to make cutter management and selection very quick and easy, and reduces the possibility of programming jobs with incorrect cut depths and speeds and feeds. The Tool Database is accessed from the **Select...** button every time you create a new toolpath and allows pre-defined tools and settings (speeds, feeds, stepover etc.) to be selected from a list.

New tools can be added, copied from existing tools, deleted and organized. All of the cutting parameters are stored in the database.

## Opening the tool database

To access the Tool Database you can click on the Database icon on the Toolpaths Tab:

Alternatively, select **Toolpaths ► Tool Database** from the main menu bar.

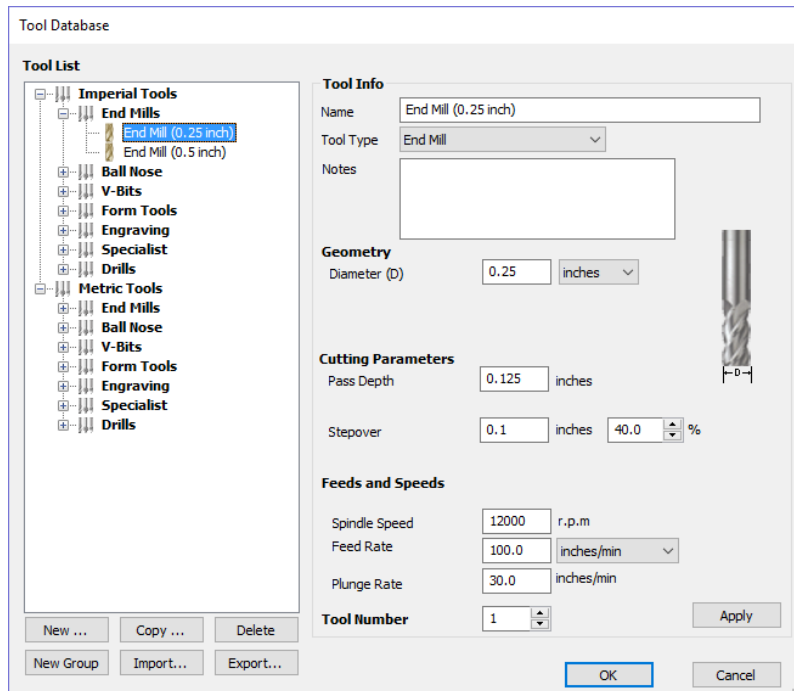

A window similar to that shown will appear displaying a list of the tools that are currently defined on the left and the parameters for the currently selected tool from the list over on the right. Below this image is a list of all the actions that can be executed from this dialog:

## Tool List

The Tool List is located on the left-hand side of the Tool Database. Click on items in the list to see or edit their properties using the Tool Info section of the database window. The Toolpath list is arranged hierarchically to allow you to organize your tools according to common properties or use.



You can click and hold down the left mouse button to drag items up or down in the list. If you drag them into a tool group, they will be placed inside the group.

## Tooltip of group hierarchy

When a tool is selected within a toolpath strategy page, the tool name does not always provide enough information for you to know whether the tool's settings are appropriate. It is always possible to click Edit and see the full set of the tool's properties and settings. However, if you hover your mouse over the tool's name, a tooltip will pop-up telling you what the location of this tool was in the tool group hierarchy when it was added to the toolpath strategy. This can be extremely useful for quickly distinguishing between tools in your database that have similar names, but have been grouped according to their properties.

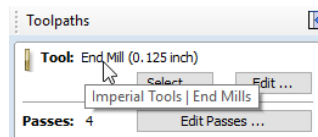

## Adding a New Tool

Selecting **New...** creates an empty tool in the list that can have any user definable name.

## Copying a New Tool

Copy adds a duplicate of the selected tool to the list and prefixes the original name with (1). Edit the Name and properties for the new tool and click the Apply button to save the changes to the list.

## Deleting a Tool

Deletes the selected tool from the database.

**Note:** Take care when deleting tools as this operation cannot be undone.

## Creating a new tool group

Click on the add **New Group** button then give your new group a name and press **Apply** to add it to the database. Click and drag tools from the database over the top of the newly created group icon in the tool database tree to add them to the group. Alternatively, select the group and then click the **New...** button to create a new tool directly within the selected group.

## Importing and Exporting tools

Individual tools or complete tool group hierarchies can be saved to disk using the **Export...** button. Similarly, you can import previously saved tools, groups or even entire tool databases using the **Import...** button.

**Note:** Cut2D Desktop will import database files from earlier versions, so you can easily add any previously defined tools to your new database. Please note, however, that you will not be able to open the new Cut2D Desktop database files in earlier versions.

## Tool Info

When a tool or group is selected in the Tool List, its properties are displayed in the Tool Info section on the right-hand side of the Tool Database.

Here you can modify any of the properties of the currently selected Tool or Group. Click the **Apply** button to save the changes to the Tool List.

**Note:** If you modify the Tool database, your changes will only be saved if you click **OK**. If you exit the Tool Database window using the **Cancel** button, any changes you have made since opening the Database will be discarded.

## Name

Use this field to enter a suitable name to describe your cutters.

## Tool Type

Various cutters can be specified in the database.

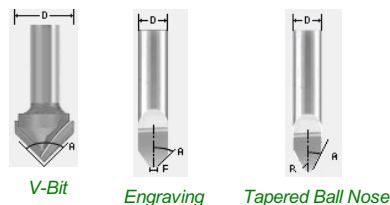

**Note:**

When specifying the geometry for a tool, the angle specified is different for V-Bit and Engraving Tools. V-Bit Tools are defined using an **Included Angle (A)** Engraving Tools are defined using the **Half Angle (A)** and the **Flat Diameter (F)**

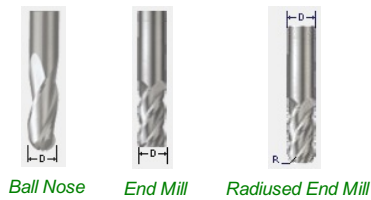

## Notes

The tool notes section simply allows you to save any additional text descriptions, special instructions or relevant information you may require, within your tool definition.

## Geometry

### Diameter

The diameter of the tool in either inches or mm. The tool image will indicate where this dimension is taken from. If you change the tool diameter but do not change the tool name then you will be warned.

## Cutting Parameters

### Pass Depth

The maximum depth of cut the tool can cut. The Pass Depth controls the number of z level passes that are calculated for a toolpath. For example, creating a pocket 1 inch (25.4 mm) deep using a tool that has a Pass Depth of 0.25 inches (6.35 mm) will result in the toolpath making 4 passes.

### Stepover

The distance the cutter moves over when doing area clearance cutting. For example, when raster machining the cutter will machine along the X axis, stepover in the Y direction and return parallel to the first line of cut. The greater the stepover the faster the job will be machined, but this must be balanced with the material being cut and the tooling being used, to ensure that the tool does not break.

When stepover's greater than 50% of the cutter / tip diameter are used the software automatically adds 'Tail' moves in the corner regions of toolpaths to ensure material is not left on the job for offset based strategies. When using V-Bit Tools, the Stepover fields automatically change to use the following options.

### Final Pass Stepover

The distance the cutter moves over when finish machining and is usually set to be a relatively small distance to produce a smooth surface finish on the job.

### Clearance Pass Stepover

Only used when a V-Bit tool is being used to rough machine at multiple Z levels down to a specified flat depth. This stepover can be much larger than the Final Pass Stepover because the tool is only rough machining material away. Increasing the Clearance Pass Stepover will reduce the machining time, but you must be careful to ensure it is not too great for the material being cut.

## Feeds and Speed

### Spindle Speed

Speed of tool rotation, specified in revolutions per minute

### Feed Rate



The surface cutting rate at which the cutter is moved in the material. The units can be specified in distance per second or minute.

## Plunge Rate

The cutting rate at which the cutter is moved vertically into the material or during ramping moves. The units can be specified in distance per second or per minute.

**Note:** The Feed rate and Plunge rate you should use will vary depending upon the material being machined and the tooling being used.

## Maximum Burn Rate

This is the maximum speed at which the tool, when at 100% power, will still burn the material. This value is used for simulation purposes only. It should be calibrated to match your laser and material. A larger value will result in the simulated toolpath appearing darker.

**Note:** You will need access to the Laser Module to create and simulate laser toolpaths.

## Tool Number

This is the number of the tool needed to machine the job. When using a CNC machine with an Automatic Tool Changer (ATC), it is critical that the correct tool required to cut the job is located in the corresponding carousel location.

## Using Form Cutters

Form Cutters can be added to the Tool Database so that industry standard Ogee and Round-over type cutters, plus user definable custom shapes can be used for edge profiling and decorative carving. Examples of these types of cutters and the kind of cuts they can be used for are shown in the images below:



Round-over



Ogee



Profile Cutting Strategy with Form cutter

## Adding your own custom form cutters

Adding a Form cutter to the Tool Database is straightforward and the procedure is,

Before opening the tool database, draw to exact scale the Right side of the cutter geometry in the 2D Window Use the Node Editing tools to create the arcs and curves etc.

Only draw the Right-hand side of the cutter geometry to the correct size and scale as shown in the image above.

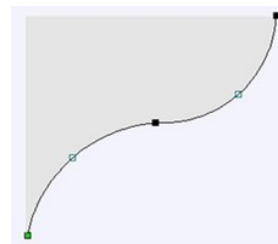

The shape can be a combination of Lines, Arcs and Bezier spans. With the vector Selected open the Tool Database (using the command icon on Toolpaths tab or from the main menu, **Toolpaths ► Tool Database** In the Tool Database window, click  Select Form Tool

The selected geometry will be imported and a profile displayed in the window. Give the Cutter a meaningful name and enter the cutting parameters - speeds and feeds etc. Click the  button to save the new cutter into the database list so it can be used at any time.

**Note:** Cutter geometry can be imported as dxf, eps files and used to create Form Tools in the database.

# Preview Toolpaths



Calculated toolpaths can be previewed to see exactly what they will produce when cut into the material. The 3D preview mode also allows the job to be viewed in different material types with the option to paint the machined regions with a Fill Color.

## Material and Rendering Settings

The pull-down list offers a range of material types to shade the 3D model. The first entry in the list is 'Use Solid Color' and if this is selected the color for the material can be selected from the color picker form.

See Adding Custom Materials below for adding your own materials.

### Machined Area Color...

#### Material Color

With this setting, the areas of your preview will simply be colored using the material defined above. Effectively this switches off independent material settings for your machined areas.

#### Global Fill Color

Paints **all** the machined regions with the selected color. Selecting the associated pull-down list opens the default color selection form. Click on one of the preset colors, or click **More Colors...** to create a completely custom color.

#### Toolpath Color

If this option is selected, each toolpath can have a different color assigned. If the 'No Fill' option is selected from the color picker form, the current toolpath will be shown in the material color.

#### Animate preview

This option will show the material being removed by the cutter as the preview is drawn.

#### Draw tool

This option will show a wireframe animation of the tool (to scale) cutting the job.

## Toolpath Preview Tools

### Preview Toolpath

This option animates the selected toolpath cutting into the material

### Preview Control Simulation

The preview controls provide full video-like playback control of your toolpath. You can use this mode to analyze the tool moves in detail, step-by-step. To begin using **Preview Control**, click on either the **Run**, **Single Step** or **Run to Retract** buttons.

The **Preview Control** buttons are summarized below:

- |  |                       |   |
|--|-----------------------|---|
|  | <b>Run</b>            | Begins Preview Control simulation   |
|  | <b>Pause</b>          | Temporarily halts the tool in its current position and enables the Stop button so you can exit Preview Control mode |
|  | <b>Single Step</b>    | Moves the toolpath on by one tool move.   |
|  | <b>Run to Retract</b> | Runs the toolpath to the next retract move, then pauses the tool.   |
|  | <b>Stop</b>           | Exits Preview Control mode.   |

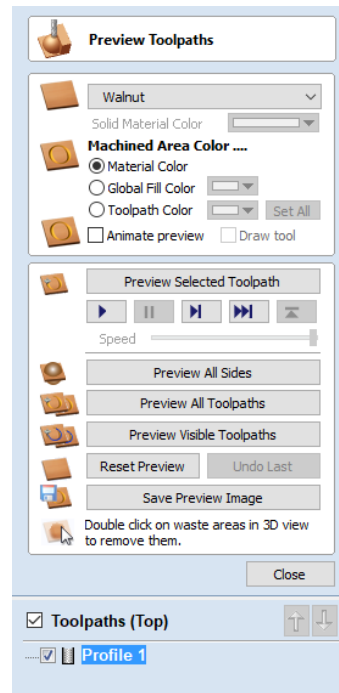

**Note:** To cancel the process of previewing a toolpath using Preview Control, first click the *Pause* and then the *Stop* buttons.

## Preview All Sides

This option animates all calculated toolpaths cutting into the material on both sides if working in a two sided environment without being in the 'Multi Sided View' mode (This option will be grayed out if working in a single sided setup)

## Preview All Toolpaths

This option animates all calculated toolpaths cutting into the material

## Preview Visible Toolpaths

This command allows you to identify a subset of toolpaths to be simulated, quickly and easily:

Isolate the toolpaths you wish to preview by un-ticking the visibility checkboxes of the other toolpaths in the **Toolpath List**.

Verify that the 3D View is only displaying the toolpath previews of the toolpaths you are interested in.

Click  to begin the simulation.

## Delete Waste Material

If a profile toolpath is calculated the excess material around the edges of the job can be automatically removed to show the finished job.

## Reset Preview

Resets the material back to a solid block

## Save Preview Image

Saves an image of the 3D window as a BMP, PNG, JPG or GIF file

**Note:** Saving the image as a PNG without the Color Shaded Background is often useful when the image will be used on its own in a brochure or on a web site etc.

## Adding Custom Materials

Additional materials can be added to the library list by simply copying an image file (JPG, BMP or TIF) of the material or image you wish to render the job with into the Textures folder within the 'Application Data Folder'. You can open the Application Data Folder from within the program using the **File ► Open Application Data Folder** menu command. The location of this folder is different on different operating systems, but as an example for \ProgramData\Vetric\Cut2D Desktop must be restarted when new materials are added.

Shading textures can be obtained from sources such as the internet, clipart libraries or simply create your own from a digital or scanned photographs. For good quality results the image needs to be approximately 1000 pixels x 1000 pixels. The texture image is simply scaled proportionally in X and Y to fit the longest side of the job.

## Multi-Colored Toolpath Preview

When previewing the effects of each toolpath it is possible to assign different colors to each one. This can be used to simulate the effects of differently painted areas both as a way to verify what is being cut by the toolpaths and also to provide an image that can be emailed or printed for customer approval.



Shaded Preview Image



Finished Sign



The different colors can be set from the Preview Toolpath form - this appears automatically when a toolpath is calculated or can be accessed anytime by clicking the bottom, left icon in the Toolpath Operations area of the Toolpath Tab:

**Toolpath Operations**



When this icon is clicked (or immediately after a toolpath is calculated) then the Preview form will be shown. The options for defining the fill color are contained in the Machined Area Color area of the form:

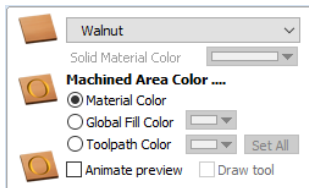

## Solid Material Color

Before the individual toolpath color fill is covered it is worth pointing out another feature within the preview form. There is the option at the very top of the Material List to select a Solid Color for the surface of the part. Once this is selected the color choice can be made from the drop-down Solid Material Color area. This allows material with a different solid color surface and core to be easily represented.

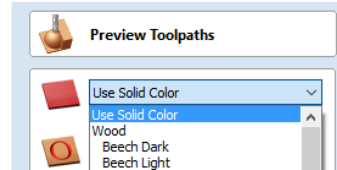

## Machined Area Color

### Use Material Color

Checking  this option will use the same color/material for the fill as you have selected for the material itself.



### Use Global Fill Color

Checking  this will use the same single fill color for all toolpaths:



### Use Toolpath Color

Checking  this will let you select different colors for each toolpath in your list:

To set the color individually, first select the toolpath from the Toolpath List and then click on the drop down arrow next to the color block to show the form:



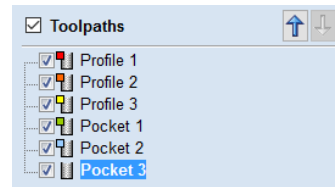
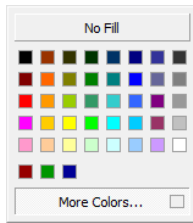

Choose the color you want for the fill of that toolpath and it will be applied to the areas that the toolpath has carved when they are previewed. Once you assign an individual color a small square of that color will be displayed next to the name in the toolpath list. This can be seen top left of each tool icon:

If you click the option at the top of this form where it says **No Fill** then this will leave that toolpath in the selected Preview Material Color.

### Set All

Clicking the Set All button will set all the toolpaths in your Toolpath List to the currently selected color. ONLY click this if you want to change all toolpaths to have the same color as you cannot undo this operation.

## Using the Multi Colored Toolpath Preview option with 3D toolpaths

When assigning an individual color it will be applied to the whole toolpath. If you are cutting a part in Cut2D Desktop with a number of 3D shapes in it you would only be able to assign different colors to them if they were cut with individual toolpaths. In most cases with 3D parts it would probably be better to create a multi-colored image for a customer by shading the components and saving an image of the 3D model than trying to assign different colors to the toolpath preview. This will also allow the use of not just solid colors but the materials for the different parts.

It is worth repeating with regard to the 3D toolpaths that there is the ability to select the No Fill option from the color choice to keep the toolpathed area in the same finish as the material surface.

# Estimating Machining Times



This option estimates the machining times for all calculated toolpaths based on the feed rates specified for each tool. The estimates for individual toolpaths plus the overall machining time of all visible toolpaths are calculated using the user defined Rapid Rate moves and Scale Factor.

## Times

The estimated machining times are displayed in Hours: Minutes: Seconds

## Rapid Rate

The maximum feed rate at which the machine runs for rapid moves, typically specified using a G0 or G00 move

## Scale Factor

The nature of different styles of toolpaths means that they may be simple 2D cuts or require simultaneous 3-axis moves, the more complex the toolpath then the more chance the CNC machine may not actually achieve the programmed feed rates. This can be compensated for by multiplying the times by the Scale Factor.

The inaccuracies generally come from the acceleration / deceleration of the machine. If the program tells a machine to move at 200 inches / min along a 200 inch straight line the machine will probably take pretty close to a minute.

If instead of a straight line we ask the machine to cut say a gear wheel with a total circumference of 200 inches, the machine is likely to take considerably longer. This is because the machine will have to slow down to go around the tight curves of gear tooth profiles and will probably never reach its programmed speed before having to slow down again for the next change in direction.

The scale factor in the program lets you approximate this slowdown for your machine, but it will vary depending on the type of work you are doing. Many people will use one scale factor for simple 2d work and another for 3d or VCaving. The best way to calculate it is just to take a note of estimated and actual machining times of a period of time.

If a job actually takes 6 minutes to cut and the estimate was 3 minutes, the scale factor would be set to 2 (actual time / estimated time = 6/3).

For machines where the controller provides an estimated machining time, these should be more accurate as the controller can determine where the machine is accelerating / decelerating and take account of this.

Toolpaths Summary	
<b>Total machining time:</b>	00:02:21
<b>Pocket 1</b>	00:00:51
<b>Profile 1</b>	00:01:30

Time estimates based on ....

Rapid Rate: 100.0 mm/sec

Scale Factor: 2.0

Notes

Apply

Close

**Note:** The information displayed on the form for each toolpath can be selected, copied and pasted into another document.

# Toolpath Tiling



Using the Toolpath Tiling options it is possible to machine objects and designs that are many times larger than the available area of your CNC machine bed. This process is also invaluable if the maximum size of your material pieces are limited. In both cases, a much larger project can still be achieved by breaking the toolpath down into manageable tiles or strips, each of which can fit within the machinable area of your CNC machine, or on the available material blocks. Once cut, the tiles can then be re-assembled to form the finished piece.

The process of tiling begins by creating toolpaths based on the final object entirely as normal - at this stage you do not need to take any account of the available machining bed size. Once you have calculated required toolpaths, click on the toolpath tiling button in the toolpaths pane to open up the toolpath tiling form.

## The Toolpath Tiling Manager

The toolpath tiling form will 'split' the full-size toolpaths into a number of discrete, but precisely aligned, toolpath tiles as soon as you click the Update Tiles button. Any toolpath arcs spanning a tile boundary will remain as arcs after tiling.

While the Tile Toolpaths mode is enabled (using the checkbox on this form) any toolpaths that you save will automatically be divided into tiles.

The top section of the tiling form allows you to set the type of tiling you require (see below for more information) and the appropriate settings for each tiling strategy.

The lower section of the tiling form allows you to select and activate each of the tiles. The currently active tile can be previewed in either the 2D or 3D View.

**Toolpath Tiling Manager**

Toolpath tiling allows you to divide toolpaths into a set of 'Tiles' if you are limited by the size of your machine or material.

When the toolpaths are saved, the toolpaths will be saved in sections, one for each tile with Tn\_ added to the start of each toolpath name where n = the number of the tile.

All toolpaths will be saved with the origin in the bottom left corner at 0,0

Tile Toolpaths

Individual Tiles

Feed-through in X

Feed-through in Y

Tile Width (x)  inches

Tile Height (y)  inches

Tile Overlap  inches

**Toolpath Drawing**

Active Tile

NOTE: The active tile can also be selected by double clicking on the tile background in the 2D view.

Draw toolpaths in original position for visualisation

## Tiling Options

There are three layout strategies for tiled toolpaths, the most appropriate one will depend on your machines capabilities and the available material.

### Individual Tiles

The first tiling option is for individual tiles. This splits the current job in both X and Y, to form a series of entirely separate toolpaths. This is generally the preferred option if you have independent pieces of material to machine, or if you have a moving-bed type CNC machine that will not allow you to 'overhang' material outside of the machinable area.

With this option selected, you are asked to specify the width and height of each tile, and the required overlap (which will be applied in each direction). Tiles are created from the bottom left of your model. The overlap for independent tiles is particularly important for 2.5D toolpaths that utilize the shape of your tool bit (such as V-bit carving). 2.5D toolpaths will need to 'overrun' the edges of your tile in order to complete their cuts using the side of the bit. For this reason, the overlap distance for Independent Tiles will typically need to be at least equal to the radius of your tool bit.

### Feed-through in X or Feed-through in Y

Instead of cutting a series of individual pieces of material and assembling them later, it can also be convenient to cut a single strip of material using a series of set-ups - moving the material through the machinable area between cuts. Cut2D Desktop specifically supports this technique using the Feed-through in X/Y options. In these cases you will only need to define either the Tile Width or Height (which corresponds to your intended feed-through distance), as the other dimension is assumed to correspond to the shorter side length of your material and will match the equivalent current job dimension. Similarly, the overlap distance is only applied in the direction of the draw-through. Because you will typically be cutting the same piece of material with each toolpath tile, the overlap distance for Feed-through is not as critical as for Individual tiles and is typically used to allow for a margin of error in your set-up accuracy.

Once you have set your tiling option, click the Update Tiles button to see your settings reflected in the Tile Previews in either the 2D or 3D Views.

## Tile Previews

The 2D View indicates how the model area is split into tiles. The yellow lines indicate the tile sizes, but the light red areas also indicate the overlap region for each tile. You should pay particular attention to the fact that this overlap can take the toolpath outside of the tile boundary - this is necessary to ensure that 2.5D toolpaths, in particular, form the correct shapes at the tile edges.

An independent toolpath tile preview in the 2D View. The light red areas indicate the current overlap settings for this tile.

This image shows the same toolpath tile's 3D preview, positioned relative to the machining origin. You should note that the tool will machine negative, as well as positive, relative to its origin in this case. You must allow for this necessary effect when setting up your material and origin for machining.

When you come to machine these tiles you should take care to allow for the overlap distance when setting your machining origin on your material. Internal tile toolpaths can machine negative, as well as positive, relative their origin.

The currently active tile can be set directly from the 2D View by double-clicking on the background of one of the indicated tile regions.

## Simulating Tiled toolpaths

You can also view and simulate individual toolpath tiles in the 3D View. To view the toolpath tiles, simply ensure that the toolpaths are visible (checked  in the Toolpath List) and then select the tile you wish to see either from the Tile Toolpaths form, or the 2D View (see above).

Since tiles are created so that they will all be cut within the same machinable area (i.e. they are all located in a similar position relative to the machining origin), this can make them difficult to visualize using Preview Toolpaths. Simulating each toolpath tile in its absolute position will result in the toolpaths being cut in the same region of your preview block and they will overcut the same area. The Tile Toolpaths form has an option *Draw toolpaths in original position for visualization* to allow you to simulate the tiles as if they were arranged in their final pattern. With this option enabled, you can visualize how your final piece will look by previewing all your toolpath tiles together, but you should note that it will not reflect the true offset of each toolpath from your machining origin.

## Saving toolpath tiles

Provided you have created toolpath tiles using the Tile Toolpaths form, an additional option, Output Tiled Toolpaths, will be available in the toolpath saving form.

It will be checked  or unchecked to match the current state of the Tile Toolpaths check box in the Tile Toolpaths form.

**Note:** If the Output Tile Toolpaths option is grayed-out this means that no tiles have been created. You will need to close the Save Toolpaths form and use the Tile Toolpaths form to create the toolpath tiles before continuing.



# Saving Toolpaths



This option allows toolpaths to be saved in the appropriate file format needed to drive the CNC machine. Toolpaths can be saved as individual files for each tool used or as a single file containing multiple toolpaths for CNC machines that have automatic tool changers.

## Individual Toolpaths

CNC machines that require the tooling to be changed manually will typically need a separate toolpath for each cutter used. The procedure for saving this type of toolpath from Cut2D Desktop is to:

1. Select the toolpath to save from the Toolpath List
2. Click on the Save option and the Save Toolpaths form is displayed.
3. Select the correct Postprocessor for the CNC machine from the pull-down list
4. Click the Save Toolpath(s) button
5. Enter a suitable Name and click the Save button

**Note:** When multiple toolpaths are created using the same tool geometry and tool number, they can be saved into a single file by selecting the option to - Output all visible toolpaths to one file.

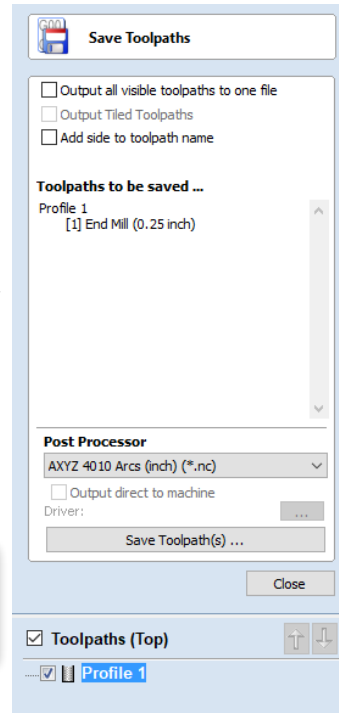

## Automatic Tool Changing Support

CNC Machines that have Automatic Tool Changing (ATC) capabilities can work with a single file that contains multiple toolpaths, each having a different tool number.

The postprocessor must be configured to support ATC commands for your CNC machine. Contact your software or machine supplier for more details.

The procedure for saving these toolpaths is,

Use the Up and Down arrows to order the toolpath list in the cutting sequence required.

Tick each toolpath to ensure it is drawn / visible in the 3D window as shown:

Click on the Save option and the Save Toolpaths form is displayed. Select the option **Output all visible toolpaths to one file**

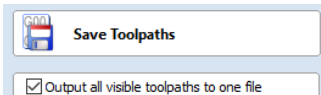
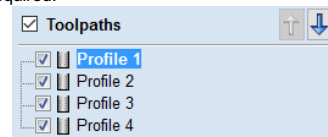

The names of the toolpaths that will be written into the file are displayed along with the tool number in square brackets [1]. If a calculated toolpath is not required, simply tick to undraw it.

Click the **Save Toolpath(s)** button Enter a suitable Name and click the **Save** button

## Error Messages

The postprocessor automatically checks to ensure:

- It has been configured for saving files that include ATC commands
- A different tool number has been defined for each different cutter being used.

An error message will be displayed to indicate the problem if either of these items is not correct.

## VTransfer

VTransfer is a small helper application provided by Vectric to simplify the process of sending toolpaths to some gbrl-based controllers. You should run VTransfer on the PC to which your CNC machine is connected via a USB serial connection. If your Vectric CAD/CAM software is also running on the same PC, you can use Direct Output mode to send toolpaths to VTransfer directly, without the need for file saving or loading.

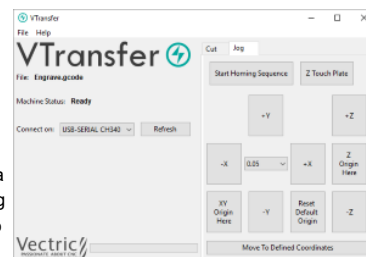

As well as streaming toolpaths, also VTransfer provides the commands you need to initiate basic homing, jogging and setting of origins on your CNC machine before a toolpath is run.

**Please Note:** VTransfer has been created specifically for streaming toolpaths to a pre-configured controller. It expects that your controller is correctly set-up and tested for your hardware. VTransfer will not set, alter or validate your controller's parameters in any way and is not intended to be used for lower-level controller configuration.

## Getting Started

Before starting VTransfer, you need to ensure that your machine is powered on, any required drivers are already installed and the machine is accessible via a serial port (COM port on Windows). For most machines connected by USB, you will need to have installed the appropriate device driver for your machine controller. These drivers will be provided by your machine tool supplier and you should verify that your CNC machine connects correctly to your PC before attempting to use VTransfer.

When the machine and drivers have been installed correctly, refreshing and checking the drop-down *Connect On:* list will show your machine tool controller. VTransfer will still need to know the specific communication protocol required though and the first time you use VTransfer you will need to complete some one-time set-up and configuration.

Once set-up for a machine that remains connected to the same USB port of your PC, VTransfer should automatically detect and connect each time it starts-up. However you will need to

## Initial Set-up

Once this initial set-up has been completed VTransfer should automatically detect and connect to your machine on start-up, provided the machine remains connected to the same USB port of your PC. Before connecting to your machine for the first time, however, you should complete the following steps to set the right controller type and machine configuration.

- Select File->Settings from the main menu to open the Settings dialog
- Make sure that your controller is selected in the *Controller Name:* drop down list (for a grbl version 1.x controller this will be *Grbl*, for example)
- Select the correct configuration file for your machine, or create your own.

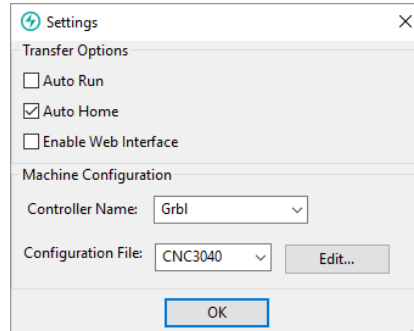

## Controller Connection

- Make sure that your machine is connected to the PC via USB and it is powered on
- Click the **Refresh** button regenerate the *Connect On:* drop down list with all of the detected devices connected to your PC
- Select your controller device from the list - note that this may be the name of the microcontroller on which your controller is running, rather than the controller name itself (grbl may appear as *Arduino UNO*, for example)
- Check that the Machine Status reported by VTransfer reads *Looking for...* followed by the expected controller name
- Machine Status will change to *Connecting* while VTransfer attempts to verify the controller is communicating as expected
- Once correct communication has been established the Machine Status will change to *Initialising, Alarm or Ready* depending on how your machine is configured

## Running a toolpath

Once connected to your CNC machine, the typical steps for running your first toolpath using VTransfer are:

- Open the **Jog** Tab
- If your Machine Status is *Start Homing Sequence* or unlock your machine (if supported and configured)
- Load your toolpath file or send one to VTransfer via Direct Output
- If required, jog the machine to the location of the material on your CNC machine (to match the relative origin point of your toolpath) and set the **X Y Origin Here**
- Fit the required tool
- **Either** run the Z Touch Plate cycle (if supported) to set Z Zero to match your toolpath
- **Or** manually jog the tip of the tool to the material surface or machine bed (again to match the Z Zero setting of your toolpath) and set the **Z Origin Here**
- Ensure the spindle is on (if it is not controlled automatically)
- Open the **Cut** Tab - Click **Cut Now!**

## Sending a toolpath directly to VTransfer from your Vectric software

At the point of saving your toolpath some post-processors support the option of Direct Output to VTransfer (such as the Emblaser or X-Carve). If you have one of these post-processors selected, the *Output direct to machine* checkbox will be enabled below the post-processor selection box. With this box checked, **Save Toolpath(s)** will change to **Output Toolpath(s)** and clicking this button will automatically send the toolpath to VTransfer. If VTransfer is not already running, it will launch automatically.

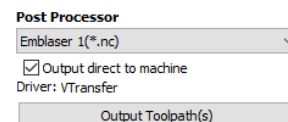

Whenever a new toolpath is loaded or received by VTransfer it will prompt you with a message box.

## Homing, Jogging and Origins

Before running your toolpath it is essential to set your machine's origins appropriately. The specific process you need to use will, to a large extent, will be determined by your machine and its configuration. Generally you will need to home your machine (if supported) and set the X Y origin to match the intended toolpath and location of the material on your machine's bed. You will also need to fit the correct tool and typically set the tip of this tool to be at Z Zero, either at the top or bottom of your material - again this choice will already have been determined when your toolpath was created. The commands relating to these actions are all available from the **Jog** tab.

Whenever VTransfer changes its origin settings you will be prompted with a message box.

### Start Homing Sequence

Click this button to initiate the homing sequence. The homing sequence will culminate in setting the origins of your machine using its homing switch locations and the machine's machineable area - both of which are set in the configuration. For some controllers (such as grbl) you will typically be required to run this command before you can do anything else because the machine will start-up in a disabled *Alarm* status.

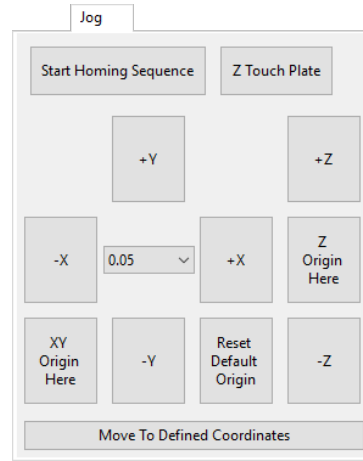

**Note:** This button is only available if your machine is configured with homing switches and homing is enabled.

### Z Touch Plate

This button will be visible if your machine is configured with a touch plate, touch plate support is enabled and its thickness is set in the configuration settings. Click it to initiate the Z touch plate probing cycle. Make sure that the touch plate is in position and correctly functioning before clicking this option as it will immediately begin a plunge move.

**Warning:** Make sure that the touch plate is in position and correctly functioning before clicking this option as it will immediately begin a probing plunge move.

### Jogging

The **+Y**, **-Y**, **+X**, **-X**, **+Z** and **-Z** buttons will each jog the machine along the Y, X or Z axes, respectively.

The distance moved by each button click is determined by the current value (in mms) shown in the down-down control at the center of the jogging buttons. Ensure that you adjust this value appropriately before using the jog buttons to move the machine.

**Note:** If the selected configuration for your machine has a Z travel value of zero, this indicates that the machine does not have a Z axis - this is the case for most laser cutters - and Z axis controls will **not** be visible.

### Setting and Resetting Origins

By default a machine with homing support will have its X Y origin (the position of the coordinate X:0 and Y:0) set to the bottom left corner of machine's machinable area following a homing cycle - i.e. the machine will operate in a positive coordinate work space within its machinable area. For machines without homing support, the initial X Y origin must *always* be set manually before running a toolpath. In addition, when a toolpath is created it is very common that the X Y origin will actually be chosen to be relative to the material (not the machine bed) - for example, the center of a design may be used. For most toolpaths, therefore, you will need to jog the machine to the matching origin location for the toolpath (relative to your material), and manually **XY Origin Here** before cutting.

For machines with homing support, you can restore the bottom left corner origin after setting it for a specific toolpath by clicking **Reset Default Origin** at any time. When this button is clicked the location of coordinate position X:0, Y:0 will once again be set to the bottom left corner of the machine's machinable area.

### Running the Toolpath

The Cut tab contains the controls need to begin cutting your toolpath and monitoring its progress.

## Cut Now

When your machine is correctly set-up (with the X,Y and Z origins set), click this button to begin streaming the toolpath to your machine and begin cutting.

**Warning:** Make sure your machine spindle is **on** before clicking this button if your spindle control is manual.

## Estimated Time Remaining

Once your toolpath has started, VTransfer will provide a dynamic estimate of the remaining time until the toolpath is finished.

## Dynamic Feedrate Override

If your machine supports feedrate override control and the option is enabled in your configuration, then the  and  buttons will be available. Click these buttons to increase or decrease the current toolpath feedrate by 10%. The current state of the feedrate override setting is indicated by the percentage value between the two control buttons.

**Warning:** Depending on the nature of the toolpath you are running, there may be a delay of one or more seconds before your machine responds to the feedrate change so allow for this when using these controls.

## Abort

This button will stop the toolpath as quickly as possible, usually resetting the controller in the process. Once a toolpath has been aborted you should re-home and re-origin before running a subsequent toolpath.

## Settings

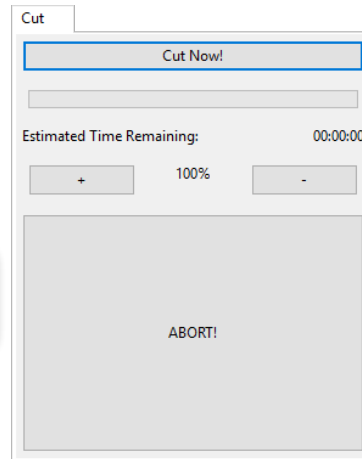

# Layers

Vectors, Bitmaps can be assigned to different layers. All the objects assigned to a layer can then be simultaneously selected, labeled, colored, temporarily hidden or even locked (to prevent accidental editing) using the Layer Management tools. Even for relatively simple designs, organizing the elements of your artwork onto layers can make managing your project much easier.

There are no specific 'rules' on how to use the layers -there are many ways to organize your design and these are likely to vary between individuals and even between different jobs. The 'meaning', therefore, of the layer organization in any particular project is entirely flexible. Some common examples of layers include:

1. Organizing artwork according to the toolpath strategies to be created.
2. One layer for shapes to be profiled, one for those to be pocketed, one for drilling etc.
3. Coloring different parts of the design to reflect different parts of the finished piece.
4. Hiding or locking geometry used as guides or temporary stages in the construction of the final design.

## Managing Layers

You can access the tools needed to manage layers from two locations: the Layer Control on the View Tool Bar, and the Layer List on the Layers tab.

### The Layer Control on the View Toolbar

A Quick Access Layer Control is conveniently located above the Views in the View Toolbar. This tool provides a pop-up Layer List, from which you can quickly change the selection of the active layer, add a new layer, or modify the properties of any existing layer. When you have finished, click anywhere outside of the Layer List window and it will cause it to close.

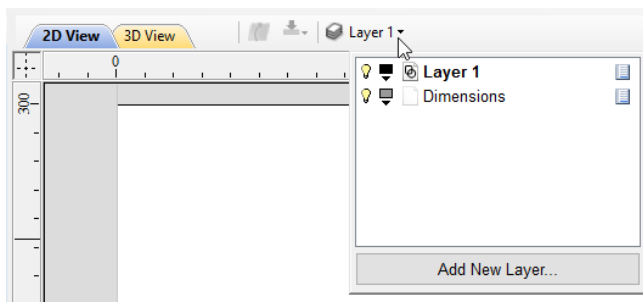

### The Layers Tab

To get a complete overview of the current layer structure of your artwork while you are working, or to carry out more extensive organization of the layers, you can also use the Layers tab. The Layer List is identical in both the Layer Control and the Layers tab, but the latter can control layer ordering and be left visible, pinned or even undocked, while you continue to work on the artwork itself.

The Layers Tab makes it very easy to work with complex designs giving quick access to all of the layer control options.

From this tab you view all the layers in your current job and modify their properties (such as visibility and color). You can also create, delete, re-order or rename them.

Most of the commands associated with layers can be accessed by right-clicking a layer in the list, or by clicking on the Pop-Up Menu icon  to the right of the layer name.

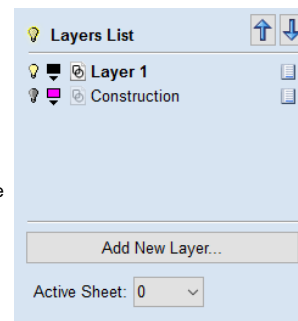

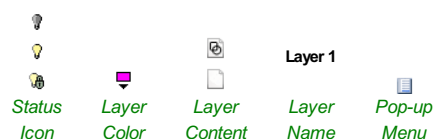

### List Item Command and Icons

Each layer in the list has five elements:



#### Status Icon



The leftmost icon indicates whether the layer is currently  visible or  hidden. Click on this icon to toggle the visibility of the layer.

The presence of a padlock  shows that the layer is locked and cannot be accidentally edited.



Right-click the layer in the list and select the Unlock command to alter this.

## Layer Color

The color swatch can be used to color all the vectors on a layer. Click on the swatch icon  and select a pre-set color from the color selector dialog, or choose  to create an entirely custom color.

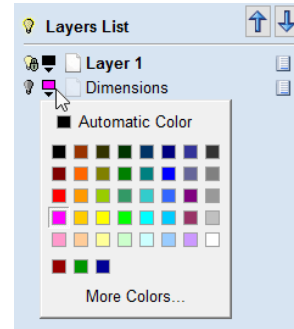

## Layer Content

The layer content icon will be grayed-out as an additional indicator that the layer is not currently visible.  a blank white sheet indicates that the layer does not currently contain any objects or vector geometry. If you import files from 3rd party CAD drawing packages via DXF or DWG format it is common for the file to include empty layers. This icon allows you to identify these empty layers and delete them.

**Note:** To delete a number of layers in one go, first hide all the layers you want to keep then use any layer's **Pop-Up Menu** icon  to select the **Merge Visible** command. All the visible layers will now be merged into a single layer, which can be deleted with a single operation.

## Layer Name

To change the name of a layer, you can double click on this part of the layer item in the list to trigger in-situ editing. This works in the same way as file renaming in Windows Explorer. Alternatively you can right-click or use the layer's **Pop-Up Menu** icon to select the **Rename** command.

**Note:** Imported images are automatically placed on a layer called Bitmap Layer. This allows images to quickly and easily be turned off in the 2D view when they are not required. The images can also be moved onto another layer if required.

## Pop-up Menu

Click the pop-up menu icon  for access to Activate, Lock, Insert, Delete and Merge layers as well as further ways to choose which layers to show and hide.

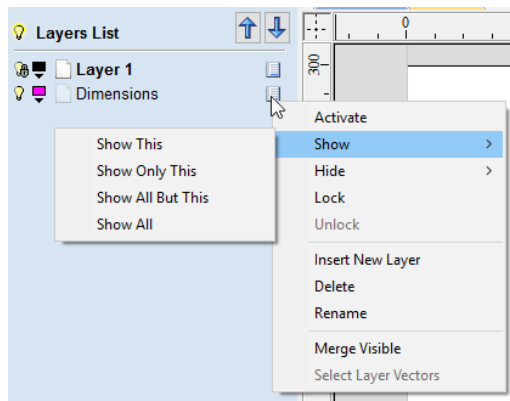

## Additional Buttons and Icons

### Show All / Hide All

The visibility icon to the left of the Layers List heading at the top of the Layers Tab will toggle the visibility of all the layers in the list.

If there are both hidden and shown layers, this icon is shown as a dim lamp: .

Clicking the dim lamp will show all layers and change to icon to a lit lamp: .

Clicking the lit lamp will hide all layers and change to icon to an off lamp: .

More options for setting the visibility of multiple items are available from the **Pop-Up Menu** for each layer under the **Show** and **Hide** menu headings.

### Select All on a Layer

Double-clicking on a layer in the Layers List will select all the objects on that layer. Alternatively you can choose the **Select Layer Vectors** command from the layer's pop-up menu.

### Layer Ordering Arrows

Adjacent to the Layers List heading label are two arrow buttons. These move the selected layer up or down in the Layers List. This can be important to set the drawing order of objects that might otherwise obscure one another (specifically Bitmap Previews). Objects on the top layers in the list are always drawn before objects in the lower layers and will, therefore, be

'underneath' them in the **2D View**. You can use the Layer Ordering Arrows to resolve this issue.

## Add New Layer

New Layers can be added using the **Add New Layer** button. Alternatively a new layer can be created directly from the **2D View** by right-clicking an object and selecting either the **Copy to Layer ► New Layer...** or **Move to Layer ► New Layer...**

The dialog for adding the new layer is displayed with options to specify the name and color of the vectors on the new layer and an option to indicate if the new layer should be visible.

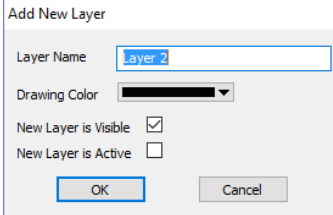

### Layer Name

It is always preferable to take the opportunity at this stage to give your new layer a meaningful name relating to its content or purpose. Later on this name will make it easier for you to manage your layers as your design becomes more complicated.

### Drawing Color

All the vectors on this layer will be colored according to this setting. This can be a very useful way of distinguishing between the vectors that are on different layers, directly in the **2D View**.

### New Layer is Visible

With this option checked,  the new layer will automatically be visible as soon as it is created.

### New Layer is Active

With this option checked,  the new layer will automatically become the active layer and any subsequent vector creation or manipulation will occur on this new layer.

## Insert New Layer

An even quicker way to add new layers is via the **Insert Layer** command from a layer's right-click **Pop-Up Menu**. This command will create a new layer above the selected layer which will be visible, unlocked and colored black. After creation the new layer item's name is ready to be immediately edited by typing a new name in.

## Moving Layers

Objects on any layer can be moved onto another layer by right-clicking the object in the **2D View** and selecting **Move to Layer ► ...** from the pop-up menu.

## Program Options

The options fall into four categories:

1. Window Layout
2. 3D View Settings
3. Toolpath Settings
4. General Settings

**Note:** Many of the choices in this dialog will not take effect until the software has been exited and restarted.

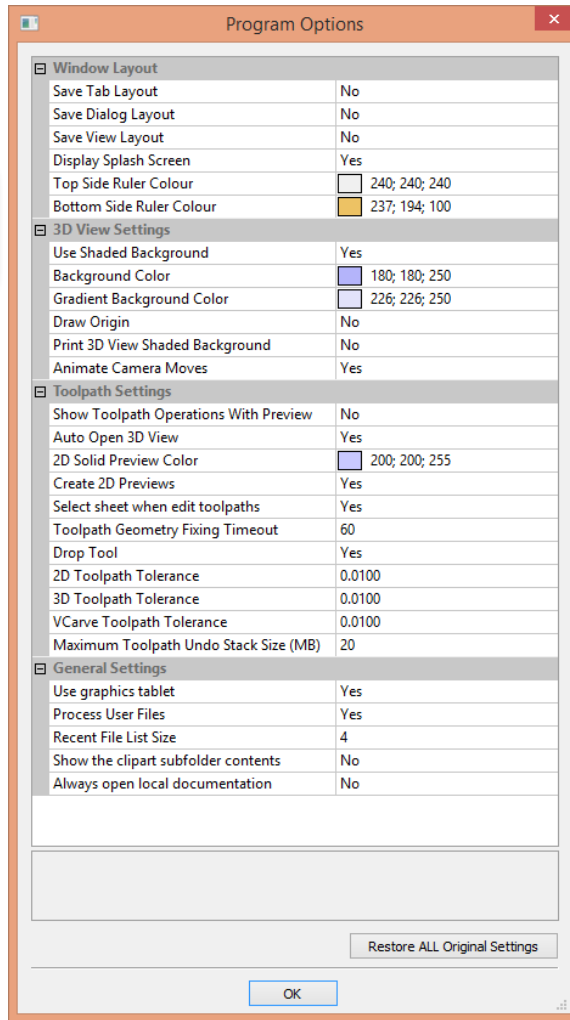

## Window Layout

- Save Tab Layout**
- Save Dialog Layout**
- Save View Layout**
- Display Splash Screen**
- Top Side Ruler Color**
- Bottom Side Ruler Color**

- Save the layout and the 'pinned' state of the command and toolpath fly out tabs.
- Save the size, position and visibility for dialogs such as the Layer control and Toolpath Control dialogs.
- Save the layout of the 2D and 3D view windows.
- Display the program Splash Screen, while the program is loading.
- The colour of the ruler on the top side in a two-sided project.
- The colour of the ruler on the bottom side in a two-sided project.

## 3D View Settings

- Use Shaded Background**
- Background Color**
- Gradient Background Color**
- Draw Origin**
- Print 3D View Shaded Background**
- Animate Camera Moves**

- Use a gradient shaded background for the 3D view.
- Change the background color used for the 3D view.
- Change the bottom (lightest) color used for the 3D view.
- Draw the origin arrows by default on startup.
- Include the shaded background when printing.
- Switch on/off animation in the 3D View when selecting View position from the Iso View, Down X, Down Y or Down Z icons.

## Toolpath Settings



<b>Show Toolpath Operations with Preview</b>	When the toolpath Preview form is visible, keep the 'Toolpath Operations' section visible (requires more screen space).
<b>Auto Open 3D view</b>	Automatically swap to 3D view after calculating a toolpath.
<b>2D Solid Preview Color</b>	Color used to draw the solid 2D toolpath preview with.
<b>Create 2D Previews</b>	Create 2D previews of toolpaths in 2D view.
<b>Select Sheet When Edit Toolpaths</b>	If a toolpath is associated with a sheet, select sheet when edit toolpath
<b>Toolpath Geometry Fixing Timeout</b>	Number of seconds the program will spend trying to fix problems with geometry when calculating toolpaths.
<b>Drop Tool</b>	When projecting a toolpath onto the model, drop the tool on surface rather than project. If this is set, the toolpath will follow the surface of the model better, but could be slower to calculate.
<b>2D Toolpath Tolerance</b>	Tolerance to apply to 2D toolpaths after calculating to reduce file size.
<b>3D Toolpath Tolerance</b>	Tolerance to apply to 3D toolpaths after calculating to reduce file size.
	Tolerance to apply to VCarve toolpaths after calculating to reduce file size.

**Note:** We strongly recommend that the Toolpath Tolerance should be left at their default settings unless different values are recommended by your machine tool manufacturer. If you do have a machine which struggles with the default settings, try doubling the values and cutting a test-piece to assess the tradeoff between machining times, file size and final machined quality. We have done some limited testing and on a sample complex 3D model, increasing the '3D Toolpath Tolerance' to 0.001 inches gave a 40% decrease in file size and no noticeable difference in quality on the test machine and job. In the test case there was no measurable difference in machining time on the CNC machine the test was carried out on.

**Maximum Toolpath Undo Stack Size (MB)** Maximum size in MB of Toolpath data undo stack for storing toolpath delete state.

## General Settings

<b>Use Graphics tablet</b>	Switch on support for graphics tablet drivers, if installed - for use with the sculpting tool.
<b>Process User Files</b>	Enable/disable processing of files in the 'Vectric Files' folder in your common user document folder.
<b>Recent File List Size</b>	This sets the maximum number of items that will be displayed in the <b>Recently opened files...</b> list in left hand side bar of the interface when there is no file currently loaded. The list will not increase in size until the software has been re-started and more files have been opened and/or saved.
<b>Show the clipart Subfolder Contents</b>	If set to Yes then this will show the contents within the selected Folder in the Clip Art browser along with up to 3 sub-folders if they exist and contain appropriate file types. If set to No it will only display the contents of the selected folder, not sub-folders.
<b>Always open local documentation</b>	Force open the local copy of the documentation when accessed through the Help menu. Cut2D Desktop automatically opens the local documentation if you have no internet connection or if the server is taking too long to respond.

## Rulers, Guide Lines and Snapping

To help with drawing, construction and layout, the 2D View has Rulers which are displayed along the top and down the left side of the window. In addition to the Rulers there is the option to use Guidelines and The Smart Cursor to help with construction of vectors or positioning of other objects in the 2D View.

### Rulers↓



The Rulers are permanently displayed in the 2D view to help with positioning, sizing and alignment. The graduated scale automatically uses the units set for the project and zooming in / out shows the sizes in 10ths.

### ← Guidelines

Guide Lines are used to help layout designs and make it very easy to sketch shapes by clicking on the intersections of Guides. Guide Lines are easily be added to the 2D view by pressing the left mouse button down on the appropriate ruler (left if you want a vertical guide and top if you want a horizontal guide) then holding the button down and dragging the mouse into the 2D view.

While dragging a Guide into position it automatically Snaps to the units displayed on the ruler. This snapping behavior can be overridden by holding down a **Shift** key while dragging the guide. After positioning a Guide it can easily be moved to a new position by clicking the *right* mouse button on the guide to open the Guide Properties form as shown later in this

section. If you hover the mouse over a Guideline then its current position is displayed next to the cursor

Additional guide lines can be added relative to an existing guide line by interactively placing the cursor over an existing guide (the cursor changes to 2 horizontal arrows), Holding a **Ctrl** key and dragging to the required position. The incremental distance between the guide lines is displayed next to the cursor. Releasing a **Ctrl** key changes to display the absolute distance from the material origin.

Guides can also be added and other edits made by *right* clicking on the Guideline which will bring up the Guide Properties form:

The exact position can be specified by entering a **New Position**.

Guides can be given an angle by either entering an angle into the **New Angle** box or dragging the slider and clicking **Apply**. Angles are measured in degrees counterclockwise from the x-axis. From an angled guide you can only create relative parallel guides.

Guide lines can be locked in position to stop them from being inadvertently moved by ticking the **Lock Guide** option.

Additional Guide Lines can be added that are positioned using absolute or incremental coordinates. Enter the Absolute or relative positions and Click **Create New Guide**.

Guides can quickly be toggled visible / invisible by clicking in the Top Left Corner of the 2D view:

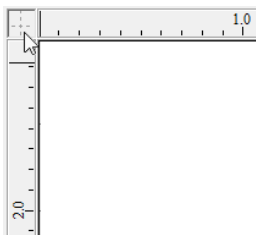

**Guide Properties**

**Selected Guide**

Current Position 1.95 Delete Guide

New Position  inches Apply

Current Angle 0.0

New Angle  °

0°  180°

Lock guide (prevent dragging)

---

**Create New Parallel Guide(s)**

Absolute position

Relative to guide Number:

Select new guide

Position / Offset  inches

**Create New Guide**

---

**Close**

Alternatively the visibility can be changed using **View Menu ► Guide Lines** from the Main Menu. Guide Lines can be Deleted by selecting **View Menu ► Guide Lines ► Delete All Guides** from the Main Menu. Individual Guide Lines can be deleted by clicking and dragging them out of the 2D View Window.

## Snapping Options

These options can be used to help create and edit vector geometry.

The Snapping Options form can be accessed by selecting **Edit ► Snap Options** from the Main Menu or by pressing **F4**.

### Display Text at Cursor

Displays the XY coordinates on the cursor making it easy to see the position for each point

### Snap to Guides

When this option is checked  drawing and positioning vectors will snap onto any horizontal or vertical guide lines visible in the 2D view.

### Snap Guides to Geometry

When checked,  the Guide Lines can snap to Geometry while being dragged.

### Snap to Grid

Displays a grid of points separated by the Grid Spacing which can be snapped to when drawing or editing vectors and other objects in the 2D View.

### Snap Distances

Snap to fixed lengths based on your zoom level. This occurs when creating shapes, dragging nodes or vectors.

### Snap to Job Center and Corners

Snap to the job corners and center. This, also, control the job smart snapping.

**Snapping Options**

**Display Text at Cursor**

**Snap to Guides**

**Snap Guides to Geometry**

**Snap to Grid**

Grid Spacing  inches

**Snap Distances**

**Snap to Job Center and Corners**

**Fixed Nudge Distance:**  inches

**Snapping Radius**

Small Large

**Geometry Snapping**

- Object Centers
- Span End Points
- Span Mid Points
- Arc Centers
- Intersections

**Smart Snapping**

- Object Bounds
- Horizontal / Vertical
- Tangents
- Perpendicular to Tangents
- Span Geometry
- Snap Angle Increments

Angle Step  degrees

**OK**

## Fixed Nudge Distance

Objects can be moved small, fixed distances (nudged) by holding **Ctrl + Shift** and tapping the arrow keys. The **Fixed Nudge Distance** specifies the distance to move selected objects with each nudge.

## Snapping Radius

The snap radius (pixels) will adjust how close the cursor must get to vector geometry in order to snap it. If you work quickly and grab and throw geometry at speed, you may prefer a larger Snapping Radius to pick up geometry that is vaguely near the mouse. If you work precisely or have complex overlapping geometry, you may prefer a smaller Snapping Radius to avoid having to zoom in to select one geometry in an area that has many nearby vectors.

## Geometry Snapping

Used to control the position at which the cursor will snap when drawing and moving objects. When drawing, the cursor will snap to items on vector geometry depending what options you have selected in the form under this section.

Object centers, Span End points, Span Mid-points, Arc centers, intersectionsHorizontally, Vertically and the specified Angle and Distance Guide lines and the intersection of Guides

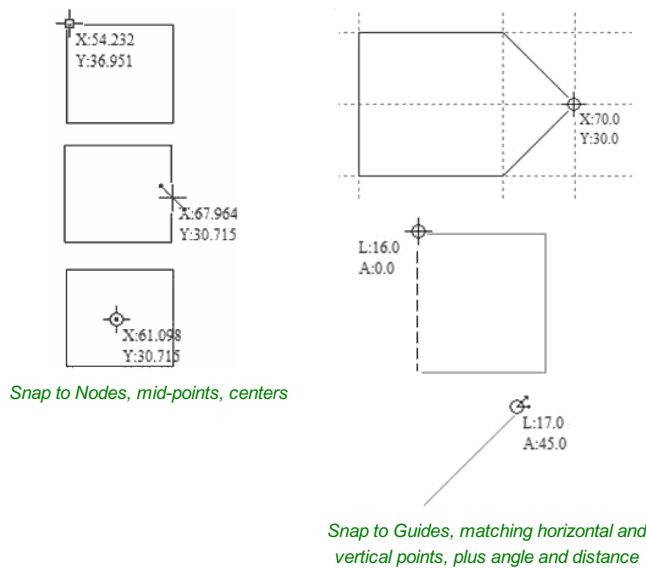

## Smart Snapping

Smart snapping works by snapping the cursor to imaginary lines related to vectors and/or nodes. These lines will appear as dashed, and sometimes coloured, lines that go through the vector or node and the cursor point. You can snap to the intersection of those lines by hovering over the nodes that you're interested in. This reduces the need to create construction geometry (for example, for aligning nodes or vectors), and can be used in almost all the shape creation tools, node editing and transforming vectors.

**Note:** A **node** is the start, middle, or end point of a **span**.

**Note:** The snapping system is watching to see which vectors you hover the mouse over. It remembers that last few vectors as the ones you want to work with and draws the snap lines for those as a priority. There is a maximum number of nodes and vectors that can be "woken up" at the same time to avoid too many snap lines appearing at once.

Snapping lines can be drawn from:

- Nodes that were woken up by hovering the mouse over them or their span
- Vector properties, such as their bounding box or center point
- Material properties, such as extensions from the edge and the middle

**Note:** It is possible to wake up vectors on the other side of a double-sided job.

Cursor	Type	Color	Description
+ <sup>S</sup>	Object Bounds	Cyan	The theoretical bounding box surrounding the active vector + horizontal and vertical lines passing through the centre
⊕ ⊖	Horizontal and Vertical Lines	Dark Grey	Horizontal and vertical lines passing through a node or a span midpoint.
+ <sup>S</sup>	Tangents	Dark Grey	Tangents originating from a node or a span midpoint.
+ <sup>S</sup>	Perpendicular to Tangents	Dark Grey	Lines which are perpendicular to tangents from nodes or span midpoints.
+ <sup>1</sup>	Connecting Lines	Yellow	Lines connecting two nodes. Includes mid-point
👁️	Span Geometry	(No line)	Snap to the geometry of the vector
⊕	Angular Constraints	Light Grey	Snapping to specific angles, as defined in the snap options F4
⊕ ⊖	Job	Dark Grey	Horizontal and vertical lines through the center of the job.

### Object Bounds

These snap lines appear on the bounding box edges of the vector, and in the middle horizontally and vertically.

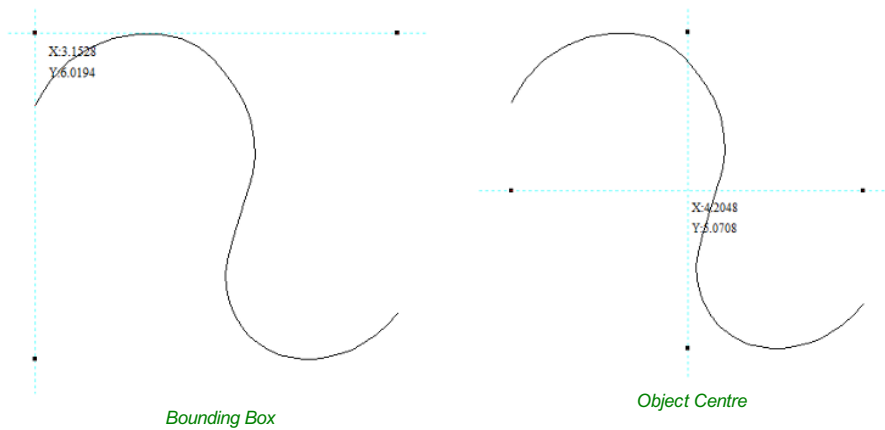

### Vertical and Horizontal Lines

#### Nodes

The snap lines appear when the cursor is near the horizontal or vertical line passing through the woken nodes.

#### Vectors

Snap lines become available while moving vectors so that it is used for aligning them with other vectors.

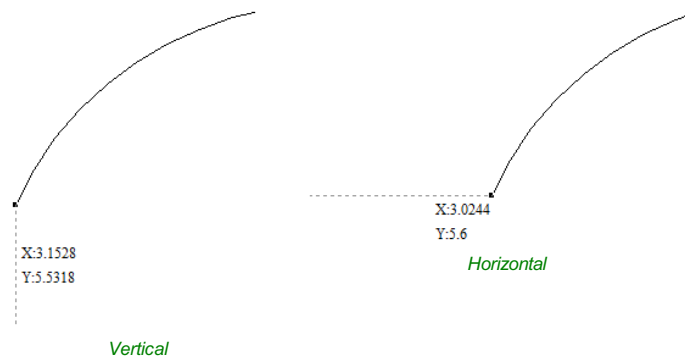

### Tangents

These snap lines originate from the woken node and will appear as an extension along the end of the belonging span.

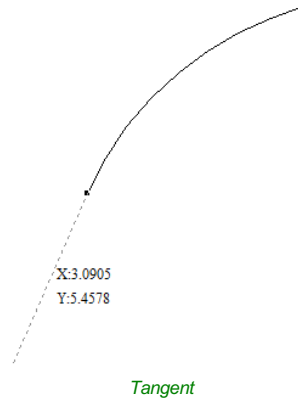

### Perpendicular to Tangents

These snap lines will be 90° from the tangent snap line, and they both

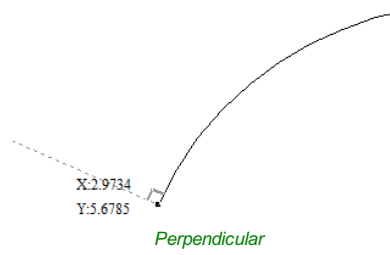

### Connecting Lines

If you wake two or more nodes, you could snap to the line connecting them. You could, also, snap to the mid-point of that line.

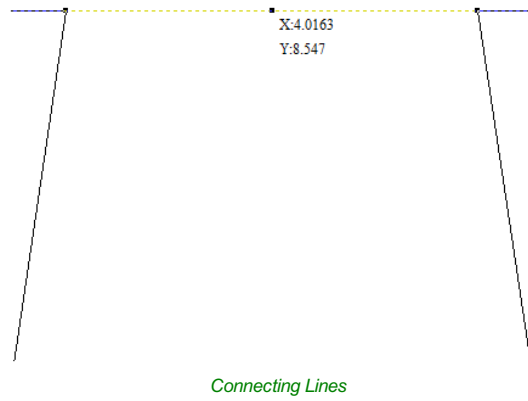

### Span Geometry

This allows you to snap to the geometry of the vectors.

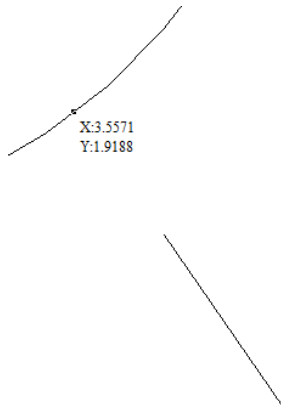

*Span geometry*

### Angular Constraints

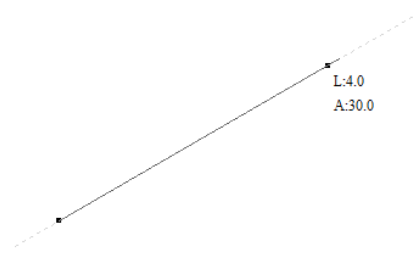

*Angular Constraints eg. 30° (Angle step 15°)*

### Job Edges & Centre

If you have the job snapping enabled, you could snap to the horizontal and vertical middle lines. This, also, includes the lines extending from the job's edges.

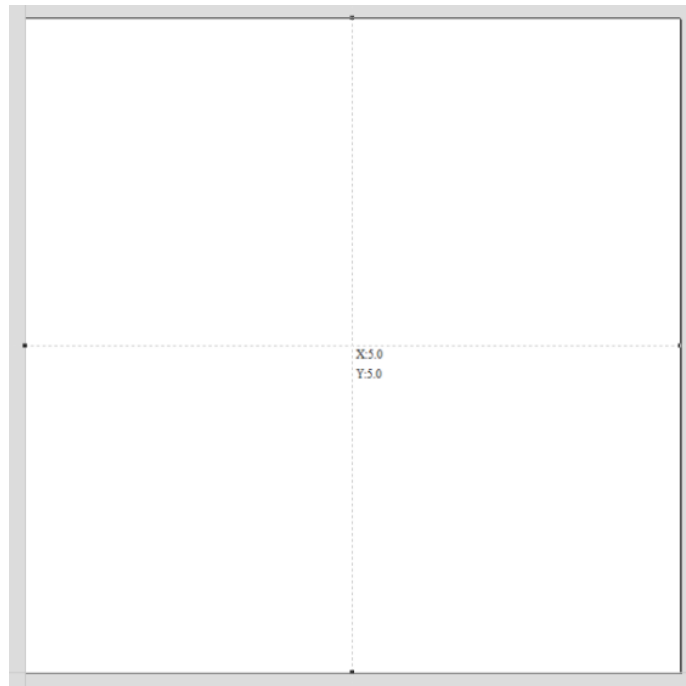

*Job Center*

### Toolbar Snapping Options

Geometry Snapping, Smart Snapping and Grid Snapping can be switched on and off from the View Toolbar

Any change to the snap settings **F4** , through the Main Menu, or the toggles on View Toolbar will be remembered for subsequent sessions.

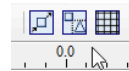

**Disable snapping temporarily**

Snapping can be temporarily disabled by holding down the **Shift** key.

# Document Variables

Document Variables provide a mechanism for defining values that can be used in Cut2D Desktop's Document Variables. They can either be created in the Document Variables dialog (right) which is accessible under the Edit menu, or created from any Calculation Edit Box which supports variables by right clicking and selecting **Insert New Document Variable** from the Popup Menu.

## Naming Document Variables

Right-click an edit-box to insert a new or existing Document Variable:

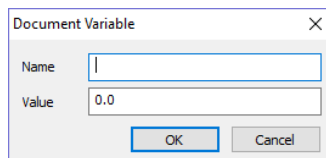
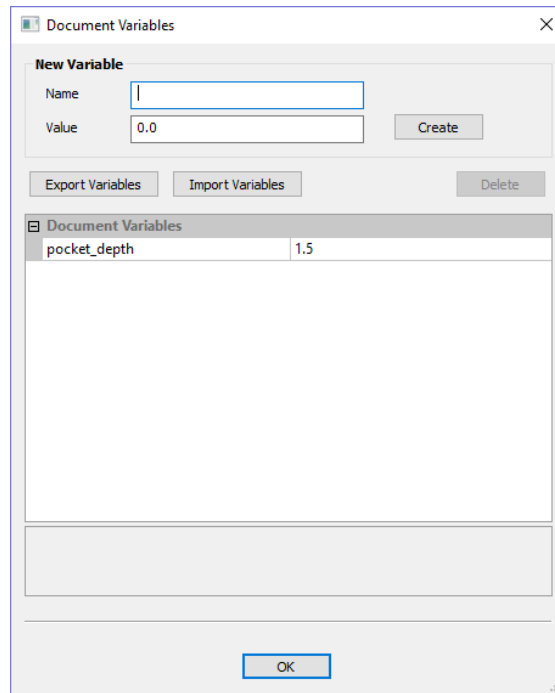
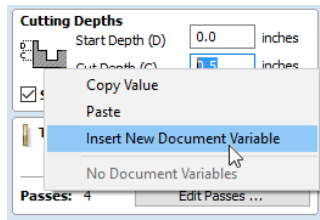

New Document Variable names must begin with a letter and then may consist of letter, number and underscore characters. Once created, they may be edited in the table beneath the New Variable section for the Document Variables Dialog.

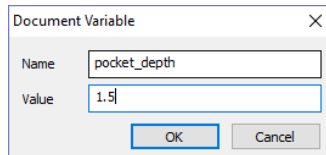

Variables can be exported to a text file and imported into another job. When importing, any existing variable values with the same name will be replaced.

## Deleting Document Variables

Variables may be deleted if they're not being used in any toolpath calculations but only when there are no toolpath creation forms open.

## Using Document Variables

Once created a Document Variable may be used in any Calculation Edit Box by enclosing its name within a pair of curly braces as illustrated in the figure below.

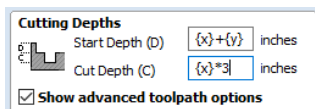

Right clicking in a Calculation Edit Box provides a Popup Menu that provides shortcuts for creating new Variables and inserting existing variables into the Edit Box.

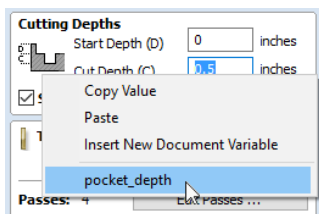

Once a Document Variable has been created from the Popup Menu it will be inserted into the Edit Box.



## Accessing Document Variables

Declared Document Variables can be easily accessed from a calculation edit box. Right-click on the calculation edit box and you will be presented with a menu showing the document variables available currently, as well as an option to quickly insert a new document variable.

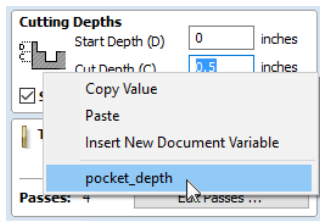

# Calculation Edit Boxes

Numerical edit boxes generally support simple calculations.  
A sum can be entered directly into the edit box:

x:  y:

Having typed an equation, pressing the  $=$  key will perform the entered calculation and fill the edit box with the answer.

## Special Calculation Characters

As well as the simple numerical calculations, such as  $3+(4/5)$ , several of Cut2D Desktop's stored values can be accessed by using certain letters (which are not case-sensitive): When used, Cut2D Desktop substitutes the character with the appropriate value in the calculation.

Character	Name	Example	Description
W or X	Material Width	w/2=	Half of the material width
H or Y	Material Height	H*2=	Twice the height of the material
T or Z	Material Thickness	t-0.25=	0.25 units less than the material thickness
P	PI (3.141593)	P*10^2=	Area of a 10 radius circle ( $\pi.r^2$ )
I	Imperial Conversion	25.4*i=	Converts 25.4mm to inches
M	Metric Conversion	2*M=	Converts 2 inches to millimetres
'	Feet	2'+10=	34 inches (2 feet and 10 inches)

# Main Menu



Clicking on any of the options on the title bar (File, Edit etc.) will result in a drop-down menu appearing with choices related to that topic.

Many of these are just an alternative way to access functions also accessed through the icons. However, there are a few commands that are unique to the Drop Down menu. Each menu and its contents are discussed later in this section of the manual.



Only unique items which do not have an equivalent icon that has already been discussed in the manual will be dealt with in detail.

File      Edit      Toolpaths      View      Help

## File

	<b>New</b>	Creates a New Cut2D Desktop job.
	<b>Open...</b>	Opens an existing Cut2D Desktop job
	<b>Close</b>	Closes the current file but leaves the software running
	<b>Save</b>	Saves the current Cut2D Desktop file over the last saved version of the file.  <b>Note:</b> This command will overwrite the old file with any changes made since the last save. If you are not sure of your changes then use the File ⇒ Save As... command instead option and give the file a new name.
	<b>Save As...</b>	Opens the standard File Save dialog so you can save the current file with a new name.
	<b>Increment and Save</b>	The Increment and save operation allows you to automatically number iterations of files you are working on. If you select this operation when editing a file which ends with an underscore, or a hyphen followed by a number, then the number will be increased by 1 and the file will be saved using this number.  For example, MyFile_1.crv3d becomes MyFile_2.crv3d MyFile-1.crv3d becomes MyFile-2.crv3d  <b>Note:</b> The increment and save option will keep incrementing until it finds a file that does not currently exist. It will not overwrite an existing file.
	<b>Print</b>	Opens the Print Setup box to Print your design
	<b>Print Preview</b>	Displays a Preview of the design to print
	<b>Print Setup</b>	Opens the Print Setup box to Print your design
	<b>Import... ►</b>	Import various entities into the job
	<b>Export... ►</b>	Export vectors from the job
	<b>Open Application Data Folder...</b>	Opens the Windows folder where files used by the software are stored. This is useful for adding to the default files installed initially.  Application files include: Bitmap textures for creating custom materials. Gadget scripts for customized automation of the software. Postprocessors The Tool Database Default toolpath strategy settings Vector texture files.
	<b>Exit</b>	Closes the job and exits the software.

## Import

	<b>Import Vectors...</b>	Import Vector data.
	<b>Import Bitmaps...</b>	Import Bitmap data
	<b>Import PhotoVCarve or Cut3D Toolpaths...</b>	Import a toolpath file created in another Vectric application, such as, Cut3D or PhotoVCarve.

## Export

- **EPS** Allows you to export selected Vectors as either an eps, dxf, ai, svg or pdf format vector file. If no vectors are selected, the all visible vectors will be exported.
- **DXF**
- **AI**
- **SVG**
- **PDF**

**Note:** When exporting in DXF format, the layer information relating to the exported vectors is preserved.

## Printing and Print Preview







The contents of either the 2D or 3D view can be printed using the **Print...** command on the File menu. Simply select the view you wish to print (2D or 3D) and then click the **Print...** command. The standard Windows printer dialog allows you to select the printer and adjust its properties. When the OK button in this dialog is clicked, the view will be printed. To adjust the printer settings without printing, you can open the same dialog using the **Print Setup...** command on the File menu. When used in this way, the **OK** button on the dialog will store the settings without printing immediately.

**Note:** By default printing the 3D view does not print the shaded background; this behavior can be changed using the Options dialog, which is opened using the Options command on the Edit menu.

The **Print Preview...** command on the File menu allows you to check the layout of your page before you print. If you are happy with the preview, use the **Print...** button to begin printing the document directly from the Print Preview page.

**Note:** The printed view is always scaled to exactly fit the currently selected page size (including allowance for margins). Drawings are not, therefore, printed at actual size and are not printed across multiple pages.



## Edit

	<b>Undo</b>	Steps backwards through the last 5 changes made by the user.
	<b>Redo</b>	Steps forward through design steps that have been Undone using the Undo command (see above) to get back to stage that the user started using the Undo function.
	<b>Cut</b>	Removes the selected objects from the job and places them onto the clipboard.
	<b>Copy</b>	Copies selected objects to the clipboard, leaving the original in place
	<b>Paste</b>	Pastes the contents of the Clipboard into the model (see cut and copy above).
	<b>Delete</b>	Deletes the selected object - same as hitting the delete key on your keyboard
	<b>Selection ►</b>	Select various types of vectors
	<b>Align Selected Objects ►</b>	Give the user all the options covered under the Align Objects section of the menu. Opens the Alignment Tools form.
	<b>Join Vectors</b>	Joins open vectors. Opens the Join Vectors form.
	<b>Curve Fit Vectors</b>	Allows arcs, Bezier curves or lines to be fitted to existing vectors to 'smooth' them. Opens the Fit Curves to Vectors form.
	<b>Job Size and Position</b>	Opens the Job Setup form.
	<b>Notes</b>	Opens a text box where you can record notes regarding this job, such as customer name, material required, special setup instructions or any other relevant text information you would like to keep when you save the job.  If the text starts with a period/full stop/dot '.', the Notes dialog will be displayed automatically each time the file is opened. The text from the Notes dialog can also be optionally output into the toolpath as a comment field. See the <b>Help Menu ► Post-Processor Editing Guide</b> .
	<b>Document Variables</b>	Opens the Document Variables dialog.
	<b>Snap Options</b>	Opens the Snap Options dialog. See Rulers, Guidelines and Snapping for more details.
	<b>Options</b>	Opens the Program Options dialog to allow the customization of certain aspects of the program.

## Selection

<b>Select All Vectors</b>	Selects all the currently visible vectors in the part (vectors on invisible layers are not selected).
<b>Select All Open Vectors</b>	Selects all the currently visible Open vectors in the part
<b>Select All Duplicate Vectors</b>	Selects all the currently visible Duplicate vectors in the part - these are vectors which are exact copies of each other in terms of shape and location so that visually they appear to be only one vector. These can cause problems for some toolpath and modeling functions so it can be useful to delete them or move them to a new layer.
<b>Select All Vectors On Current Layer</b>	Selects all the vectors on the selected layer.
<b>Unselect All</b>	Deselects all the currently selected vectors in the part
<b>Vector Selector...</b>	Opens the Vector Selector dialog.

# Toolpaths Menu

**Show Toolpaths Tab** Can be checked ✓ on or off to pin  the Toolpath Tab open or unpin  and hide it.



**Tool Database** Opens the Tool Database Dialog.



**Recalculate All Toolpaths** Recalculates all the Toolpaths in the part.

**Toolpath Drawing** ► Opens the Toolpath Drawing Pop-up Menu.

**Preview Simulation Quality** ► This controls the resolution (number of points) in the Toolpath Preview simulation model governing the amount of detail that the model will display when you Preview and toolpath. The higher the quality, the slower the speed of simulation will become. Guidelines are given on how much slower you should expect it to be but these will depend upon the performance of the PC and relative size of the tool being used to your job (the larger the tool, the slower the performance). Opens the Preview Simulation Quality Pop-up Menu:

**Standard** is the fastest mode and recommended for low performance PC's.

**High (2 x Slower)** displays better quality images and is for general use.

**Very High (4 x Slower)** displays good quality images, but will run a little slower.

**Extremely High (8 x Slower)** gives good quality images but will run slower on old PC's.

**Maximum (25 x Slower)** gives the best quality image, but could take a lot longer on any PC.

---

**Install Post Processor** Opens a File Open dialogue box where you can install a post processor.

## Toolpath Drawing sub-menu

**Draw 2D Previews** Can be checked ✓ on or off to display the toolpath previews in the 2D View.

**Make 2D Previews Solid** Can be checked ✓ on or off to switch from the wireframe view to a solid view.

**Auto Open 3D View** Selects whether the 3D view and Preview Toolpaths Form are automatically shown after toolpaths are created.

**Draw rapid moves** Toggles the visibility of red rapid-speed move lines on the 3D view when toolpaths are visible.

**Draw plunge moves** Toggles the visibility of cyan plunge-speed move lines on the 3D view when toolpaths are visible.

**Draw retract moves** Toggles the visibility of green retract-speed move lines on the 3D view when toolpaths are visible.

**Draw join moves** Toggles the visibility of purple join move lines on the 3D view when toolpaths are visible. A join move is a purely 2D move between toolpath contours, these are typically seen in Offset pattern Pocket Toolpaths.

## View



**Zoom to Drawing** Use when you need to see the whole drawing and material as large as will fit in the 2D View window.

**F5 Refresh 2D View** Shortcut key for this is **F5**. In situations where the complete vector geometry represents a very large job and the user zooms into a small region, the shape of arcs and curves may look faceted. This is only a display issue and will not impact on the quality of toolpaths. This command will rebuilds the display information to correct the graphics being drawn on the screen so curves are drawn smoothly again.

**Guide Lines** ► For more details see the section on Rulers, Guidelines and Snapping at the end of the 2D Design part of this manual. Opens the Guide Lines Pop-up Menu:

**Guides Visible:** Toggles the visibility of Guide Lines in the 2D view.

**Delete All Guides:** Deletes all the Guide Lines in the 2D view.

**Lock All Existing Guides:** Locks the position of all the Guide Lines in the 2D view.

**Unlock All Existing Guides:** Allows all the locked Guide Lines in the 2D view to be moved again.

---

**Draw Origin:** XYZ origin arrows can be toggled on and off in the 3D View to show exactly where the X0, Y0 and Z0 origin position is relative to the material.

**Draw Material Block** Toggles the drawing of a wireframe representation of the limits of the material block. This is useful for seeing how the 3D model will be positioned in the block of material it is being cut from.

---

**= Multi Sided View:** Allows you to view both sides in the 2D and 3D view when working in a multi sided environment.

**Color Shaded View:** Draws / Undraws the color shaded job in the 3D window.

**Use Shaded Background** Shows either the default gradient filled color background or a solid light blue color background. The solid color is very useful for saving images that need to be cropped out of the background in a graphics software package.

**Light follows viewer:** The default light setting for the 3D window shines a light onto the job from the top left corner of the material bounding box. Checking ✓ this option can sometimes be used to help visualize the job more easily.

**Save Shaded Image:** Saves a color shaded image of the 3D view as a BMP, JPG, PNG or GIF file.

**Note:** Saving the image without the color shaded background is often useful when the image will be used on its own in a brochure or on a web site etc. If you select PNG as the file type with the shaded background switched off the image will be saved with a transparent background. To switch the shading off, go to **Edit ► Options ► Use Shaded Background** and set Use Shaded Background to *No*.

Page Down **Tile Windows Horizontal:** Tiles the 2D and 3D View Horizontally, 2D View at the top and 3D at the bottom.

Page Up **Tile Windows Vertical:** Tiles the 2D and 3D View Vertically, 2D View on the left and 3D on the right.

**Cascade Windows** Cascades the 2D and 3D View so they overlap.

To Maximise the windows again,  double-click the title-bar of either view.

## Help

**Help Contents:** Displays an online version of the full reference manual that documents every feature and option available in the software.

**Note:** The reference manual is not intended as a User Guide or introductory training resource - please don't forget about the Getting Started guides and the extensive video tutorial library on your install DVD.

**Keyboard Shortcuts:** Displays the Shortcut Keys available in the software.

**Video Tutorial Browser...:** Access the tutorials

**What's New:** See a summary of the new features added in major updates.

**Release Notes:** See the list of issues fixed and enhancements in patch updates.

**Enter License Code Displays the License Dialog used for entering license or module details.**

**View the Vectric Online FAQ...:** Displays the Frequently Asked Questions (FAQs).

**View the Vectric User Forum...:** Opens the Vectric User Forum in your Web Browser if you have an Internet Connection. Everyone should join the Forum to engage with other users and benefit from each others tricks and tips!

**Visit Vectric Support online...:** Opens the Vectric Support Website in your Web Browser if you have an Internet Connection.

**Visit Vectric User Portal...:** Opens the Vectric User Portal in your Web Browser if you have an Internet Connection. Download software installation files and activation codes included with the software.

**Post Processor Editing Guide:** Opens a PDF manual explaining how to create and edit your own post processors.

**Migrate From Older Version** Opens a dialog to enable the settings in the last version of Cut2D Desktop to be copied to the latest version:

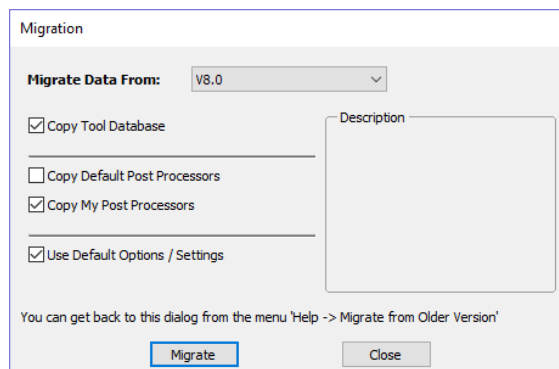

**Check for Updates** Try this periodically to check (through the Internet) if an update is available for your software.

**About Cut2D Desktop...** This window displays the version of the software being used, to whom the software is license and the type of license.



# Right Mouse Click menus

Clicking the ►RIGHT hand mouse button in different places inCut2D Desktop will display a menu with choices which depend on the area of the software being clicked on and/or the object or selection that the mouse cursor is positioned over. This document details some of these areas and the menus that you will see when RIGHT mouse clicking.

## 2D View Right Mouse Menu

Undo	Ctrl+Z
Redo	Ctrl+Y
Cut	Ctrl+X
Copy	Ctrl+ C
Paste	Ctrl+V
Delete	Del
Selection	>
Activate Layer of Selection	
Group Objects	
Ungroup Objects	>
Break Text Block Into Lines	
Convert To Curves	
Join / Close Vectors ...	>
Node Edit Mode	N
Guide Lines	>
Object Properties ...	
Copy to Layer	>
Move to Layer	>
Move to Sheet	>
Copy to Other Side	
Move to Other Side	

This menu is displayed when you Right mouse click in 2D View either in the white background of the part or over a selected vector. Most of these options repeat functions and icons described elsewhere in this manual, you should refer to the appropriate section to view how these work.

The Copy to Layer, Move to Layer and Move to Sheet options are unique to this Right click menu. Copy to Layer allows you to copy an object onto an existing Layer or to create a New one to copy it onto. Move to Layer gives you the same choices but moves the original object rather than making a copy. Move to Sheet can only be used if you have generated additional Sheets through the Nesting process, in that case it allows you to move objects from one Sheet to a different one from the list available.

## Span Editing Menu

If the currently selection mode is set to Node Editing, one of 2 different menus will appear when the user clicks the RIGHT mouse button depending on whether the cursor is currently over a vector Node or a Span in the selected vector in the 2D View. These menus have functions in them that correspond specifically to this selection and position. The menu below will appear when the cursor is over the Span of a vector in Node editing mode. You can see a variety of choices: to convert the span to a Line, Bezier (curve) or Arc, Insert a Point, Cut the Vector at that point, Delete the Span, or Insert a Midpoint. All these have corresponding Short Cut keys (shown to the right of the command in the menu) which can be selected from the key-board when the mouse is in position (over a node-edit vector span) instead of Right Clicking the mouse button to access the menu.

to Line	L
to Bezier	B
to Arc	A
Insert a Point	I
Cut Vector	C
Delete Span	D
Insert Midpoint	
Reverse Direction	
Close Vector ...	>
Exit Node Edit Mode	N

## Node Editing Menu

Delete Point	D
Smooth Point	S
Insert a Point	I
Cut Vector	C
Make Start Point	P
Mirror Horizontal	H
Mirror Vertical	V
Close Vector ...	>
Exit Node Edit Mode	N
Properties ...	X

This menu will appear when the cursor is over the Node of a vector in Node editing mode. You can see a variety of choices to convert the span to Delete the Point, Smooth it, Cut the vector at that point or change the point to be the Start Point on the vector. From this menu you can also close the vector, Exit the node editing mode and lastly see and edit the exact XY co-ordinate position of the node by selecting Properties. All these have corresponding Shortcut keys (shown to the right of the command in the menu) which can be selected from the key-board when the mouse is in position (over a node-edit vector node) instead of Right Clicking the mouse button to access the menu.

## Bitmap Properties Dialog

When a Bitmap or Component Grayscale is the selected item in the 2D View and the RIGHT Mouse menu is activated then there will be an additional option in the pop-up menu called **Object Properties**. This will open the dialog shown below which can be used to fade the Bitmap or Grayscale object strengthen or fade the detail in it when it is not selected. This can be helpful to make it easier to see features perhaps to help you manually trace vectors over it or to fade them so its easier to see vectors that overlap the object.

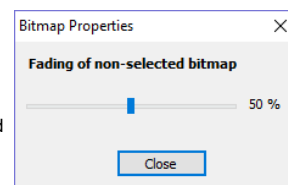

## Component Grayscale Menu



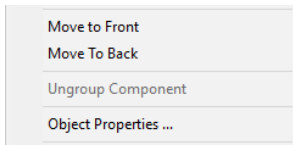

When a Component Grayscale is the selected item and Object Properties is selected it opens the Bitmap Properties slider, allowing you to change the fading of the grayscale component. Two other options are also available on the Right mouse click menu for a selected Component Grayscale. Move to Front and Move to Back. Clicking Move to Front will make the selected Grayscale appear over all the other Grayscales on the same layer so you can see the selected one more easily. Move to Back will send the selected one behind all the others on the same layer so that it is

easier to see all the other Grayscales in the part.

## Component Menu in the 3D View - Selected Components

When a component(s) is selected in the 3D view you can RIGHT mouse click and make changes to that selected component(s). You can check the combine mode of a component. You can Unselect a single component or Unselect All depending on how many components you have currently selected. You can hide and delete a component. You can open up the properties form for that component and you have the option to move the selected component(s) to an existing or new Level.

If you choose New Level you will be presented with the box below, where you simply add in the name for the new level and choose a combine mode from the dropdown menu.

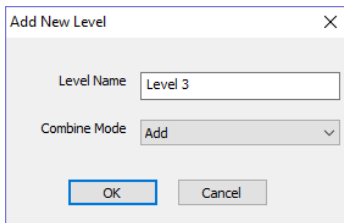
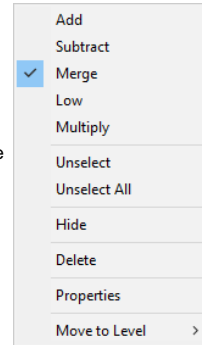

## Component Menu in the 3D View - Non Selected Components

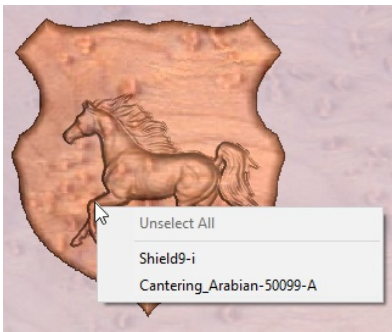

When you RIGHT click on a component without selecting it first the menu will display the names of the components that are positioned at the point your cursor is within the job space. Selecting the name of the component will select it and open up the Properties form for that selected component.

## Clipart Menu

When you RIGHT click on a piece of clipart in the clipart tab you have the option to import it to a new or existing level in your job. This will position the object in the center of the workspace and add it to the top of the list of Components on the selected Level or if you choose New Level will allow you to enter a name and Combine Mode.

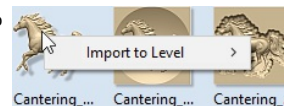

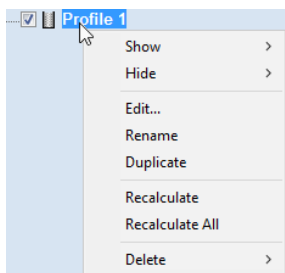

## Toolpath List Menu



When you RIGHT click on a toolpath name within the Toolpath List there are various options you are presented with to alter this toolpath. You can show a toolpath where you have the option to **Show This**, **Show Only This**, **Show All But This** and **Show All**. This toggles the visibility of the Toolpaths according to your choice. The next option allows you to **Hide This** or **Hide All** your toolpaths. You can **Edit**, **Rename** or **Duplicate** the selected toolpath. Selecting **Recalculate All** will work through the toolpath list recalculating each toolpath with any updated geometry selections. The last option allows you to delete one or more toolpaths, where you can **Delete This**, **Delete All Invisible**, **Delete All Visible** and **Delete All**.

# Shortcut Keys

## General Shortcut Keys

Shortcut key	Description
Ctrl + A	Select All vectors
Esc	Deselect All vectors
 Select ← Right to Left	Selects all vectors inside and touching selection rectangle
 ► Select Left to Right	Only selects vectors fully inside selection rectangle
N	Toggles between Selection and Node Editing modes
Esc	Switches to Selection Mode (exits Node editing or Transform mode)
T	Opens the Scale form for Transforming the vectors
M	Opens the Move form
R	Opens the Rotate form
J	Opens the Join Vectors form
Ctrl + M	Opens Measure tool form
9	Rotates selected object 45° counterclockwise
0	Rotates selected object 45° clockwise
Esc	Exits vector drawing and editing tools and closes the data entry form
 Right mouse click	Exits vector drawing and editing tools and closes the data entry form
Space-bar	Re-opens the last vector creation form you used. This is very useful when using other forms in between each shape / text / dimension you create.
Z	Zoom - click top left and bottom right corners to zoom
Esc	Exits zoom mode returning to Selection mode
CRTL + F	Zoom to fit Job
F	Zoom to fit Material
F6	Zoom to fit Material
F1	Opens the Help File
F2	Opens the 2D Drawing window
F3	Opens the 3D Preview window
F4	Opens the Snap Settings form
F5	Refreshes the 2D window
F6	Scales 2D view to fit material
F9	Center selected object in view
F10	Opens the Alignment Tools form
F11	Toggle Drawing Tab on
F12	Toggle Toolpath Tab on

## Tab Navigation

Shortcut key	Description
F11	Toggle Drawing Tab on
F12	Toggle Toolpath Tab on
Ctrl + L	Opens the Layers Tab
Ctrl + D	Opens the Drawing Tab

## Double Sided Job Setup

Shortcut key	Description
1	Toggle Top Side on
2	Toggle Bottom Side on
=	Toggle Multi-Sided View on

## Mirror

Shortcut key	Description
H	Mirror <b>Horizontally</b>
Ctrl + H	Create Mirror <b>Copy Horizontally</b>
Shift + H	Mirror <b>Horizontally</b> , around <b>center</b> of material
Ctrl + Shift + H	Create Mirror <b>Copy Horizontally</b> , around <b>center</b> of material
V	Mirror <b>Vertically</b>
Ctrl + V	Create Mirror <b>Copy Vertically</b>
Shift + V	Mirror <b>Vertically</b> , around <b>center</b> of material
Ctrl + Shift + V	Create Mirror <b>Copy Vertically</b> , around <b>center</b> of material

## Alignment

Shortcut key	Description
F9	Moves selected object to the center of the material
F10	Opens the Alignment Tools form

## Groups





Shortcut key	Description
G	Group the selected objects
U	Ungroup the selected objects to their original layers, sub-groups remain grouped.
Ctrl + U	Ungroup the selected objects to the group's layer, sub-groups remain grouped.
Shift + U	'Deep' ungroup the selected objects to their original layers. Sub-groups are also ungrouped.
Ctrl + Shift + U	'Deep' ungroup the selected objects to the group's layer. Sub-groups are also ungrouped.

## Arrow keys

Nudge selected vectors using the Arrow keys

- Holding **Ctrl** reduces the nudge distance
- Holding **Shift** increases the nudge distance
- Holding **Ctrl + Shift** nudges the selected object by the Fixed Nudge Distance which is specified in the Snap Settings ( **F4** )

## Node Editing

Shortcut key	Description
I	Insert a Point
D	Delete Point / Span
S	Smooth / Unsmooth Point
C	Cut Vector opens the vector
B	Convert span to Bezier
A	Convert span to Arc
L	Convert span to Line
P	Makes the selected node the Start Point for machining
X	Displays a single node's X and Y location properties
X	Changes the X co-ordinate position of selected nodes to match the position of the first one (when more than one selected)
Y	Changes the Y co-ordinate position of selected nodes to match the position of the first one (when more than one selected)
H	Enter horizontal mirror mode (press again to exit)
V	Enter vertical mirror mode (press again to exit)
 Right mouse click	Opens context sensitive menus
Ctrl + Z	Edit Undo
Ctrl + Y	Edit Redo
Ctrl + C	Copy the selected vectors
Ctrl + V	Paste the selected vectors
Ctrl and Drag 	Pastes a copy of the selected vectors each time the left mouse button is released.
Ctrl + X	Cut the selected vectors
Alt and Drag 	Moves the object either horizontally or vertically aligned with its original position
Ctrl + Alt and Drag 	Creates a copy of the original object horizontally or vertically aligned to its original position
Ctrl + N	Create New file
Ctrl + O	Open an Existing file
Ctrl + S	Save file
Ctrl + I	Import file
Page Up	Vertically tiles the 2D View and the 3D View window so you can see them both simultaneously. Currently Selected window is on the left - typically best to select the 2D View first when doing this.
Page Down	Horizontally tiles the 2D View and the 3D View window so you can see them both simultaneously. Currently Selected window is at the top - typically best to select the 2D View first when doing this.

## Quick Keys

Pressing the **Space-bar** re-opens the last vector creation form you used. This is very useful when using other forms in between each shape / text / dimension you create.

Various values can be typed in while dragging out shapes as follows:

**Note:** In most cases, the left mouse button must be pressed in order to input a value (i.e. dragging to create a circle, dragging a vector to move it, or dragging one of the rotating/scaling points around a vector to rotate/scale it).

The exception to this is the polyline tool: once the first point is entered the Quick Keys can be used without having to depress the left mouse key. Entering values defines the next end-point.

## Moving Objects **M**

### Drag Object

*Value* Enter

*Value* , *Value* Enter

*Value* X *Value* Y

### Description

Moves object the L Value from original position in direction of cursor.

**Equivalent to:** *Value* L .

Moves object relative to its position by X and Y.

**Equivalent to:** *Value* D *Value* W .

Moves object to the absolute position X and Y

## Rotating Objects R

### Drag Rotation Handles

*Value* Enter

### Description

Rotate the selection by R degrees counterclockwise.

**Equivalent to:** *Value* L .

## Scaling Objects T

### Drag Scaling Handles

*Value* Enter

*Value* , *Value* Enter

*Value* S

### Description

**Default when dragging edge scale nodes only.**

Set the width or height of the object to 'L' (depending on which handle is being dragged).

**Equivalent to:** *Value* L .

**Default when dragging corner scale nodes only.**

Set the width and height of the object to the given values.

**Equivalent to:** *Value* D *Value* W .

Scale the object by a factor.

## Node Editing N

### Drag Node

*Value* Enter

*Value* , *Value* Enter

*Value* X *Value* Y

### Description

Moves node from original position by that amount in direction of cursor.

**Equivalent to:** *Value* L .

Move the node by that amount relative to its current position.

**Equivalent to:** *Value* D *Value* W .

Moves node to the absolute position X and Y

## Polyline Tool

**Note:** Once the first point is entered the Quick Keys can be used without having to depress the left mouse key. Entering values defines the next end-point.

### Value after adding first point

*Value* Enter

*Value* , *Value* Enter

*Value* X *Value* Y

*Value* A *Value* L

### Description

Places next point L away from the last point in the direction of cursor.

**Equivalent to:** *Value* L .

Place the next point offset by that amount relative to the last point's position.

**Equivalent to:** *Value* D *Value* W .

Places the next point at position X and Y

Creates a line with an angle of A° and a length L

## Draw Circle

### Value(s) while Dragging Mouse



### Description

**Value** Enter

Create a circle with the given **radius**.

**Equivalent to:** **Value** R .

**Value** D

Create a circle of Diameter D

## Draw Ellipse

### Value(s) while Dragging Mouse



### Description

**Value** Enter

Create a circle with the given **diameter**.

**Equivalent to:** **Value** L .

**Value** , **Value** Enter

Create an ellipse with width and height.

**Equivalent to:** **Value** W **Value** H .

**Value** X

Create an ellipse with width X and use the current height

**Value** Y

Create an ellipse with height Y and use the current height

## Draw Rectangle

### Value(s) while Dragging Mouse



### Description

**Value** Enter

Create a square with the given **side length**.

**Equivalent to:** **Value** L .

**Value** , **Value** Enter

Create a rectangle with given width and height.

**Equivalent to:** **Value** W **Value** H .

**Value** X

Create a rectangle with width X and use the current height

**Value** Y

Create a rectangle with height Y and use the current height

**Value** R **Value** X

Create a rectangle with a radius R and width X, using current height

**Value** R **Value** Y

Create a rectangle with a radius R and height Y, using current width

**Value** W **Value** H

Create a rectangle with width W and height H

**Value** , **Value** Enter

Create a rectangle with width and height

## Draw Polygon

### Value(s) while Creating Mouse



### Description

**Value** Enter

Create a circle with the given **radius**.

**Equivalent to:** **Value** R .

**Value** D

Creates a Polygon with diameter D

**Value** S **Value** R

Create a polygon with number of sides S and radius R

**Value** S **Value** D

Create a polygon with number of sides S and diameter D

## Draw Star

### Value(s) while Dragging Mouse



### Description

**Value** Enter

Create a star with the given **radius**.

**Equivalent to:** **Value** R .

**Value** D

Create a star with diameter D

**Value** P **Value** R

Create a star with number of points P and radius R

**Value** P **Value** D

Create a star with number of points P and diameter D

**Value** P **Value** I **Value** R

Create a star with number of points P , Internal Radius % I and radius R

**Value** P **Value** I **Value** D

Create a star with number of points P , Internal Radius % I and diameter D



# What's New in Cut2D Desktop 9.5

## Welcome to Cut2D Desktop V9!

This documentation provides a convenient guide for previous Cut2D Desktop customers to highlight new and enhanced features specific to this release of the software. It is intended as a way for existing Cut2D Desktop users to locate just the new or changed aspects of the software.

If you are new to Cut2D Desktop, don't forget that full documentation of all the features of the software can be found here , or by selecting **Help ► Help Contents** from the Main Menu on Cut2D Desktop's main window.

## New Drawing Tools

This latest version of Cut2D Desktop introduces several entirely new drawing tools and features,

### Smart Snapping

The way you draw in the software has seen some huge improvements making it quicker and easier to create and align geometry in the software with the introduction of Smart Snapping. Smart Snapping can dramatically reduce the time taken to create vector geometry. It enables geometry to be snapped to lines, extensions and intersections which don't exist as geometry thereby reducing the need for most construction vectors.

### Quick Keys

In addition to the Smart Snapping feature we have introduced the ability to transform and create shapes using Quick Keys. This allows you to add more precision to your shape creation and editing process more easily by allowing typed values while creating geometry. This is supported for creation of circles, ellipses, rectangles, polygons, stars, polylines and in editing nodes or transforming vectors.

Pressing the `Space-bar` re-opens the last vector creation form you used. This is very useful when using other forms in between each shape / text / dimension you create.

### Vector Validator

The Vector Validator is intended to help locate issues with contours after importing vector files to look for problematic issues that could potentially affect toolpath creation such as overlapping contours or intersections. It also indicates zero-length spans that are in the file, where the software can fix them at the click of a button.

## Enhanced & Extended Drawing Tools

This section details the improvements that have been made to features you will already be familiar with from earlier versions of Cut2D Desktop and includes the following:

- Text Editing (V9.5)
- Picture Editing & Cropping (V9.5)
- Dimensioning
- All Closed Shape creation tools are now fully consistent
- Create tangents lines to circles & arcs using the Polyline Tool

### Text-Editing (V9.5)

#### **T** The Create Text Form (V9.5)

From version 9.5 any text is edited in-place including Arc Text and Text on a Curve, even if it has been moved, scaled and rotated. Custom kerning and spacing is also maintained where possible.



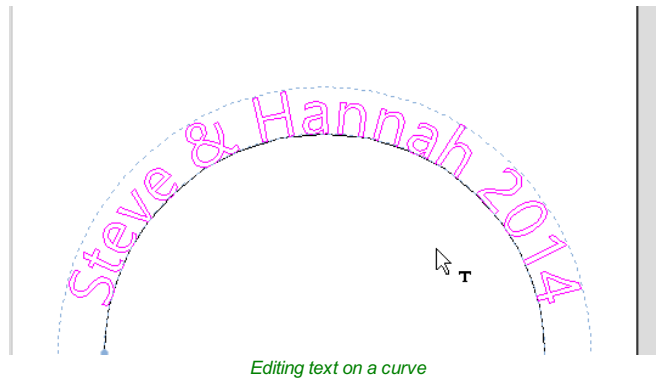

The behaviour of the Create Text form has changed to provide more visual feedback about the changes you are about to make. If the form is opened with no selection, the new text is placed somewhere on the material (if possible) between the center of the material and the center of the view to help keep it visible. An empty box is drawn in the view which helps visualize the currently specified text height and anchor point.



Existing text has guide lines showing the height of the top line of text. Some fonts will descend below the lower line like handwriting on a note pad. Clicking selected text while editing, changes the anchor point to a box which can be dragged and dropped with snap.

The view is updated shortly after the user stops changing the form properties (e.g. mouse-wheel scrolling through the font list) providing a live update of your edited or created text.

#### **Arc Text (V9.5)**

The arc sector is now drawn when editing and provides a handle at the center of the arc which can be used to move the text. The text and font properties of Arc Text can be edited using the Create Text Form whilst still keeping the text on the arc.

### **Picture Editing & Cropping(V9.5)**

#### **The Edit Picture Form (V9.5)**

The Edit Picture form allows you to adjust the visual properties of a selected bitmap. You can adjust the contrast, brightness and gamma of any selected image. Borders of different sizes and radii can be added to bitmaps. Bitmaps can also be made black and white.



*Rectangular Border*



*Oval Border*

#### **The Crop Bitmap Tool (V9.5)**

The Crop Bitmap tool can be used to select the parts of an image you are interested in, and remove the parts you are not.



## Dimensioning

Further improvements have been made to the way you can create dimensions in the software. It has been enhanced to allow faster placement and more freedom. You now have the option to edit existing dimensions while the form is open. Dimensions can now have custom text. This text is stored per dimension, so you change between calculated and custom text without losing a dimension's custom text.

**Note:** The Length, Vertical and Horizontal Dimensions allow the text to be placed freely with asnap-point-point at the center of the dimension line for consistency with previous versions (disable snapping by holding down a **Shift** key).

## Shape Creation

Improvements have been made to the way we create shapes. If a shape is selected when a shape's form is opened, the form will load its values from the selected shape, otherwise it holds the same values it had when it was last closed.

When drawing a shape, the size of the shape you are drawing will be displayed, changing appropriately for the snap radius and job size. You can now edit a shape whilst in the shape form.

## Creating Tangent Lines

Using the keyboard shortcut **T** in the Polyline Tool, you can create a tangent to and from existing arc spans or circles.

## Extending A Polyline (V9.5)

There are two new ways to extend an existing polyline:

- Open the polyline tool. With **ctrl** held down select the end point of contour you wish to extend.
- In node editing mode select the end point of the polyline you wish to edit. Then use the right-click Menu to select **Edit Polyline**. This will open up the Polyline Form with the selected polyline now being extended.

## Smother Joining (V9.5)



Version 9.5 of Cut2D Desktop upgrades the 'Join vectors with smooth Curve' method with an alternative joining algorithm which produces smoother results. Select either one or two open vectors and click the button.

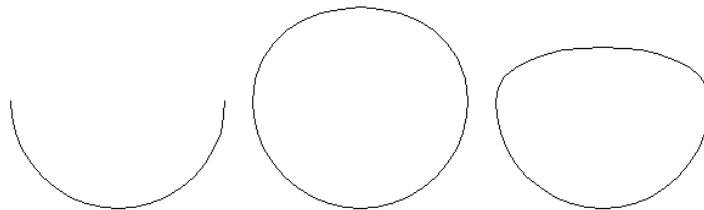

*Example of new smother joining (left) versus old joining (right)*

If you want to access the old joining method then hold the **Ctrl** button down to use the older join method. The **Smooth Join Vectors** option can be used to choose which method is the primary join method and which method is the alternative join method and hence requires **Ctrl** to access

## Bitmap Background (V9.5)

It is now possible to choose a bitmap to be a background image for your 3D view. This image can be set by setting **Edit ► Options ► Shaded Background Style** to be **Image** and specifying the image path in **Edit ► Options ► Image File Path**

## Enhanced Toolpath Features

### Setting Toolpath Start Point

Within the  Profile Toolpath form, a new **Start At** tab has been added giving you more control over the toolpaths start position. There are three options to choose from:

- **Keep current start points**
- **Optimize start points**
- and the new **Move start point to be closest to selected point on vector boundary box.**

This new third option allows you to make the start point to be closest to a selected point, to influence the start point define which part of the bounding box of the profiled vector it should start near and the software will look for the nearest point, from all of the endpoints of spans, and will start the toolpath from that point. This is particularly useful if you wanted to alter the start point to multiple vectors in your job to a common point without having to go in to each individual vector to alter them separately.

**Note:** *Keep current start points* and *optimize start points* are not new features but have been moved from the **Machine Vectors** section in the Profile Toolpath form to the new **Start At** Tab.

### Preserve Arcs across Toolpath Tiles

Previously, when tiling a toolpath, arcs were smashed to small lines if they were going across a tile. Arcs are now maintained when tiling to creating smoother, more efficient toolpaths if arcs are supported by your CNC machine.

### Helical Arc Support (V9.5)

Cut2D Desktop now supports the output of helical arcs. These are like regular arcs when viewed in 2D but where the start z and the end z differ. They are typically found in toolpaths where ramping occurs. These arcs can now be output via the newly introduced post-processor variables:

- FIRST\_CW\_HELICAL\_ARC\_MOVE
- CW\_HELICAL\_ARC\_MOVE
- FIRST\_CCW\_HELICAL\_ARC\_MOVE
- CCW\_HELICAL\_ARC\_MOVE
- FIRST\_CW\_HELICAL\_ARC\_PLUNGE\_MOVE
- CW\_HELICAL\_ARC\_PLUNGE\_MOVE
- FIRST\_CCW\_HELICAL\_ARC\_PLUNGE\_MOVE
- CCW\_HELICAL\_ARC\_PLUNGE\_MOVE

Using these moves for the output of helical arcs may result in smoother toolpaths and smaller toolpath file sizes

**Note:** Please contact your machine tool manufacturer to see if your machine tool supports helical arcs. The post-processor editing guide (accessible from within the software via **Help ► Post Processor Editing Guide**) provides a more complete treatment of the new variables

## General Improvements

### Two-Sided Job Support



Major changes have been made throughout the software to support jobs which require you to machine both sides of your material. Cut2D Desktop now helps you to manage and organize your drawings, models and toolpaths for each side of your part using simple controls. The software helps with correct alignment of your vectors and toolpaths and even provides a full 3D preview of your part as it will look when cut from both sides. For lots more information please see the new Two-Sided Machining section of the full documentation.

### View Toolbar







A new View Toolbar is displayed above the view window, which allows easier access to common tools. With the ability to create a double sided project you have easy access to switch between the Top and Bottom Sides of your project. The Layers Drop down bar has now moved from the drawing tab to the View Toolbar, making it accessible at all times. The other icons displayed in order of left to right are as follows:



### Snapping Toggle Options

-  Snap to geometry
-  Smart Snapping
-  Snap to Grid



### View Controls

-  Toggle Pan / Twiddle View
-  Zoom to box
-  Zoom to drawing
-  Zoom to selection

### Toolpath Drawing Toggle

-  Toggle 2D Toolpath Drawing
-  Toggle solid 2D Toolpath Drawing

### Tile 2D & 3D View Windows

-  Stack 2D and 3D View windows vertically
-  Stack 2D and 3D View windows horizontally

There are also additional tools available when you are working on a two-sided job. For more information, please see the Toolbar section of the documentation.

### Export to PDF

You can now export your drawings to PDF. This is a useful and standard format but it also enables you to print your drawings *to scale* on a suitable printer using Adobe or other 3rd party PDF software.



# Release Notes

## 9.519

### Issues

- Speed up Pocketing calculation when there are lots of regions.
- Fix recalculating from template using correct pass depth when using Z height from the Vector Selector.
- Fix copying of bitmap to another layer.
- Fix quadratic bezier handling in SVG.
- Correctly open the Job Sheet when pressing `CTRL` in different Job types.

## 9.518

### Issues

- Fix issue with renaming toolpaths via LUA API not affecting the toolpath list.
- Fix importing of Z height on compatible DXF.
- Fix auto z-scaling when scaling texture components.
- Fix tapered ball nose tool shape calculation affecting depth of some toolpaths.
- Fix issue with incorrect dimensions being shown for transformed text in a box.

## 9.517

### Issues

- Fix failure to remove centre when pocketing some circles in some cases.
- Fix issue with last pass allowance not being converted when project units changed.
- Toolpath list: Set horizontal scroll position to the beginning for toolpaths with long names.
- Fix renaming of duplicate toolpaths on some occasions.
- Fix various crashes in text line splitting, on software startup, and on opening file with corrupted toolpath data.
- Fix connectivity issues in VTransfer (requires reinstall of VTransfer after installing the patch)

## 9.516

### Issues

- Added Russian translation.
- Fix SVG import problem with some circular arcs.
- Fix issue with simulation slider speed. The lowest speed should now match the actual feed-rate of the tool used.
- Fix issue with helical arcs output.
- Fix trim tool picking up vectors from the opposite side.
- Fix tool database percent controls.
- Fix crash with invalid toolpath previews.
- Fix imported toolpath cut depth display for rotary jobs.
- Fix component preview shading for flat planes.
- Fix 64bit uninstall leaving entry in 'Apps & Features' list.

## 9.515

### Issues

- Allow kerning text when mouse is over another object.
- Fix slowdown in two-sided jobs from updating simulation unnecessarily.

## 9.514

### Issues

- Fix crash when importing a tool database.
- Fix simulation speed slider not default to maximum value (regression in 9.513).
- Fixed crash when vector validator tool is closed while still running.

## 9.513

### Enhancement

- Add support for importing SketchUp 2018 files.
- Support bitmap transparency when cropping bitmaps or adding a gradient border.

### Issues

- Fix crash in Job Setup form when OK button is pressed while previous action did not finish.
- Fix crash due to interaction between wrapped drawing and Job Setup form
- Fix issue when typing diameter and pressing enter in Job Setup does not change size correctly
- Prevent crash when drawing ruler bars
- Fix crash closing the text form
- Fix shift + create new job flipping the 3D view.

## 9.512

### Issues

- Show error during profile toolpath calculation if tool will not fit between vectors when using separate last pass.
- Fix occasional crash when closing profile toolpath form.
- Fix issue with inherited post processors not finding a parent in MyPostP. This now allows the X-Carve post-processor to be placed in My\_PostP.
- Update Post-Processor Guide with the newly added features.
- Fix issue with handling of tabs in profile toolpath when ramp ends at the edge of a tab
- Fixed incorrectly documented Grouping keyboard shortcuts

## 9.511

### Issues

- Restore previous behavior for snapping moved object with intersection.
- Smoother character orientation when it's aligned to a curve.
- Prevent a crash when OK button clicked twice in the Job Setup form.
- Fixed an issue when importing the SVG containing elliptical arcs.
- Fix rare crash when node editing and snapping.
- Don't exclude snapping to key points of the object being dragged to itself.
- Fix shading of the model when the height is greater than the width.
- Fix ramping z height issue.

## 9.510

### Enhancement

- Improved and re-enabled arc handling when using tiling.
- Allow arc text to be moved snapped by the arc center.
- Allow snapping in the dimension, extend and measure tool to work as everything else and intersect lines with guidelines.

### Issues

- Prevent a crash when editing text.
- Fix an issue when placing resized text on a curve.
- Fix an issue when imported model rotation is constrained to a single axis.
- Fix an issue when importing from SKP when vectors are not aligned with any of the major axes.
- Cleanup older log files.
- Prevent rare crash when simulating and there is no simulation relief.
- Prevent crash when snapping to deleted entity.
- Fixed a crash when using ramping in the profile toolpath and the ramp ends at the beginning of a long span.
- Fix profile toolpath ignoring start point option in some cases.
- Fixed exporting arcs to PDF scaling issue.
- Fixed a crash when recalculating grouped toolpaths that erroneously share the same ID.

## 9.509

## Enhancement

- Shift Click the axis buttons in the 3D view will fly to the view from the other side.

## Issues

- Display the view toolbar active layer name in red if it's invisible.
- Make toolpath visible after re-calculating through the form.
- Fix colouring issue when exporting black vectors to DXF.

## 9.508

- Fix an issue editing multi-line text in the large edit field.
- Fix crash in profiling toolpath not having any vectors to machine.
- Fix crash when using the apply template gadget.
- Fix issues when switching from double-sided job to single-sided then rotary.
- Fix some tool database importing issues including where some groups weren't being deleted.
- Fix simulation of some Array Copying toolpath types.
- Fix a pocketing toolpath issue machining some slots with certain tools.

## 9.507

- Fix crash when calculating certain toolpaths.
- Fix issue adding tabs to some profiles.
- Prevent crash when saving Array Copy toolpath template.
- Fix scaling and spacing issues on the text on a curve form.
- Fix copy pasting issues affecting text kerning.
- Fixing spacing issues with multi-line text.
- Fix error message which showed occasionally when tiling.
- Fix merging of the two-sided model and simulation.
- Make debug log file less verbose by eliminating a very occasional message.

## 9.500

See the What's New page.

# Third Party Software Used by Cut2D Desktop

The following is a list of all the third party software used to help create Aspire. Last updated on 2018/07/12.

Software	Version	Licence
Boost Libraries	1.6.5	Boost Software License
CryptoPP		Boost Software License
libCurl	7.59.0	Curl License
GraphicsMagick	1.3.18	MIT License
JsonCpp	rev 276	JsonCpp License
RapidXML	1.13	Boost & MIT License
LZMA	9.35	Public Domain
Lua	5.1.4	MIT License
Lua Bind	0.9.1	MIT License
OpenSSL	0.9.1	OpenSSL License
spdlog	0.17.0	MIT License
ZLib	1.2.11	ZLib License

Boost Software License - Version 1.0 - August 17th, 2003

Permission is hereby granted, free of charge, to any person or organization

obtaining a copy of the software and accompanying documentation covered by this license (the "Software" to use, reproduce, display, distribute, execute, and transmit the Software, and to prepare derivative works of the Software, and to permit third-parties to whom the Software is furnished to do so, all subject to the following: The copyright notices in the Software and this entire statement, including the above license grant, this restriction and the following disclaimer, must be included in all copies of the Software in whole or in part, and all derivative works of the Software, unless such copies or derivative works are solely in the form of machine-executable object code generated by a source language processor.

THE SOFTWARE IS PROVIDED "AS IS", WITHOUT WARRANTY OF ANY KIND, EXPRESS OR IMPLIED, INCLUDING BUT NOT LIMITED TO THE WARRANTIES OF MERCHANTABILITY, FITNESS FOR A PARTICULAR PURPOSE, TITLE AND NON-INFRINGEMENT. IN NO EVENT SHALL THE COPYRIGHT HOLDERS OR ANYONE DISTRIBUTING THE SOFTWARE BE LIABLE FOR ANY DAMAGES OR OTHER LIABILITY, WHETHER IN CONTRACT, TORT OR OTHERWISE, ARISING FROM, OUT OF OR IN CONNECTION WITH THE SOFTWARE OR THE USE OR OTHER DEALINGS IN THE SOFTWARE.

COPYRIGHT AND PERMISSION NOTICE Copyright (c) 1996 - 2018, Daniel Stenberg,

(daniel@haxx.se), and many contributors, see the THANKS file.

All rights reserved.

Permission to use, copy, modify, and distribute

this software for any purpose with or without fee is hereby granted, provided that the above copyright notice and this permission notice appear in all copies. THE SOFTWARE IS PROVIDED "AS IS", WITHOUT WARRANTY OF ANY KIND, EXPRESS OR IMPLIED, INCLUDING BUT NOT LIMITED TO THE WARRANTIES OF MERCHANTABILITY, FITNESS FOR A PARTICULAR PURPOSE AND NON-INFRINGEMENT OF THIRD PARTY RIGHTS. IN NO EVENT SHALL THE AUTHORS OR COPYRIGHT HOLDERS BE LIABLE FOR ANY CLAIM, DAMAGES OR OTHER LIABILITY, WHETHER IN AN ACTION OF CONTRACT, TORT OR OTHERWISE, ARISING FROM, OUT OF OR IN CONNECTION WITH THE SOFTWARE OR THE USE OR OTHER DEALINGS IN THE SOFTWARE. Except as stated in this notice, the name of a copyright holder shall not be used in advertising or otherwise to promote



Use of this software is granted under one of the following two licenses,  
to be chosen freely by the user.

1. Boost Software License - Version 1.0 - August 17th, 2003

=====

Copyright (c) 2006, 2007 Marcin Kalicinski

Permission is hereby granted, free of charge, to any person or organization  
obtaining a copy of the software and accompanying documentation covered by  
this license (the "Software") to use, reproduce, display, distribute,  
execute, and transmit the Software, and to prepare derivative works of the  
Software, and to permit third-parties to whom the Software is furnished to  
do so, all subject to the following:

The copyright notices in the Software and this entire statement, including  
the above license grant, this restriction and the following disclaimer,  
must be included in all copies of the Software, in whole or in part, and  
all derivative works of the Software, unless such copies or derivative  
works are solely in the form of machine-executable object code generated by  
a source language processor.

THE SOFTWARE IS PROVIDED "AS IS", WITHOUT WARRANTY OF ANY KIND, EXPRESS OR  
IMPLIED, INCLUDING BUT NOT LIMITED TO THE WARRANTIES OF MERCHANTABILITY,  
FITNESS FOR A PARTICULAR PURPOSE, TITLE AND NON-INFRINGEMENT. IN NO EVENT  
SHALL THE COPYRIGHT HOLDERS OR ANYONE DISTRIBUTING THE SOFTWARE BE LIABLE  
FOR ANY DAMAGES OR OTHER LIABILITY, WHETHER IN CONTRACT, TORT OR OTHERWISE,  
ARISING FROM, OUT OF OR IN CONNECTION WITH THE SOFTWARE OR THE USE OR OTHER  
DEALINGS IN THE SOFTWARE.

2. The MIT License

=====

Copyright (c) 2006, 2007 Marcin Kalicinski

Permission is hereby granted, free of charge, to any person obtaining a copy  
of this software and associated documentation files (the "Software"), to deal  
in the Software without restriction, including without limitation the rights  
to use, copy, modify, merge, publish, distribute, sublicense, and/or sell copies

of the Software, and to permit persons to whom the Software is furnished to do so,  
subject to the following conditions:

The above copyright notice and this permission notice shall be included in all  
copies or substantial portions of the Software.

THE SOFTWARE IS PROVIDED "AS IS", WITHOUT WARRANTY OF ANY KIND, EXPRESS OR  
IMPLIED, INCLUDING BUT NOT LIMITED TO THE WARRANTIES OF MERCHANTABILITY,  
FITNESS FOR A PARTICULAR PURPOSE AND NONINFRINGEMENT. IN NO EVENT SHALL  
THE AUTHORS OR COPYRIGHT HOLDERS BE LIABLE FOR ANY CLAIM, DAMAGES OR OTHER  
LIABILITY, WHETHER IN AN ACTION OF CONTRACT, TORT OR OTHERWISE, ARISING FROM,  
OUT OF OR IN CONNECTION WITH THE SOFTWARE OR THE USE OR OTHER DEALINGS  
IN THE SOFTWARE.

The JsonCpp library's source code, including accompanying documentation,  
tests and demonstration applications, are licensed under the following  
conditions...

The author (Baptiste Lepilleur) explicitly disclaims copyright in all  
jurisdictions which recognize such a disclaimer. In such jurisdictions,  
this software is released into the Public Domain.

In jurisdictions which do not recognize Public Domain property (e.g. Germany as of  
2010), this software is Copyright (c) 2007-2010 by Baptiste Lepilleur, and is  
released under the terms of the MIT License (see below).

In jurisdictions which recognize Public Domain property, the user of this  
software may choose to accept it either as 1) Public Domain, 2) under the  
conditions of the MIT License (see below), or 3) under the terms of dual  
Public Domain/MIT License conditions described here, as they choose.

The MIT License is about as close to Public Domain as a license can get, and is  
described in clear, concise terms at:

[http://en.wikipedia.org/wiki/MIT\\_License](http://en.wikipedia.org/wiki/MIT_License)

The full text of the MIT License follows:

=====

Copyright (c) 2007-2010 Baptiste Lepilleur

Permission is hereby granted, free of charge, to any person obtaining a copy of this software and associated documentation files (the "Software"), to deal in the Software without restriction, including without limitation the rights to use, copy, modify, merge, publish, distribute, sublicense, and/or sell copies of the Software, and to permit persons to whom the Software is furnished to do so, subject to the following conditions:

The above copyright notice and this permission notice shall be included in all copies or substantial portions of the Software.

THE SOFTWARE IS PROVIDED "AS IS", WITHOUT WARRANTY OF ANY KIND, EXPRESS OR IMPLIED, INCLUDING BUT NOT LIMITED TO THE WARRANTIES OF MERCHANTABILITY, FITNESS FOR A PARTICULAR PURPOSE AND NONINFRINGEMENT. IN NO EVENT SHALL THE AUTHORS OR COPYRIGHT HOLDERS BE LIABLE FOR ANY CLAIM, DAMAGES OR OTHER LIABILITY, WHETHER IN AN ACTION OF CONTRACT, TORT OR OTHERWISE, ARISING FROM, OUT OF OR IN CONNECTION WITH THE SOFTWARE OR THE USE OR OTHER DEALINGS IN THE SOFTWARE.

=====

(END LICENSE TEXT)

The MIT license is compatible with both the GPL and commercial software, affording one all of the rights of Public Domain with the minor nuisance of being required to keep the above copyright notice and license text in the source code. Note also that by accepting the Public Domain "license" you can re-license your copy using whatever license you like.

Lua License

-----

Lua is licensed under the terms of the MIT license reproduced below. This means that Lua is free software and can be used for both academic and commercial purposes at absolutely no cost.

For details and rationale, see <http://www.lua.org/license.html> .

=====

Copyright (C) 1994-2008 Lua.org, PUC-Rio.

Permission is hereby granted, free of charge, to any person obtaining a copy of this software and associated documentation files (the "Software"), to deal in the Software without restriction, including without limitation the rights to use, copy, modify, merge, publish, distribute, sublicense, and/or sell copies of the Software, and to permit persons to whom the Software is furnished to do so, subject to the following conditions:

The above copyright notice and this permission notice shall be included in all copies or substantial portions of the Software.

THE SOFTWARE IS PROVIDED "AS IS", WITHOUT WARRANTY OF ANY KIND, EXPRESS OR IMPLIED, INCLUDING BUT NOT LIMITED TO THE WARRANTIES OF MERCHANTABILITY, FITNESS FOR A PARTICULAR PURPOSE AND NONINFRINGEMENT. IN NO EVENT SHALL THE AUTHORS OR COPYRIGHT HOLDERS BE LIABLE FOR ANY CLAIM, DAMAGES OR OTHER LIABILITY, WHETHER IN AN ACTION OF CONTRACT, TORT OR OTHERWISE, ARISING FROM, OUT OF OR IN CONNECTION WITH THE SOFTWARE OR THE USE OR OTHER DEALINGS IN THE SOFTWARE.

=====

(end of COPYRIGHT)

// Copyright (c) 2003 Daniel Wallin and Arvid Norberg

// Permission is hereby granted, free of charge, to any person obtaining a  
// copy of this software and associated documentation files (the "Software"),  
// to deal in the Software without restriction, including without limitation  
// the rights to use, copy, modify, merge, publish, distribute, sublicense,  
// and/or sell copies of the Software, and to permit persons to whom the  
// Software is furnished to do so, subject to the following conditions:

// The above copyright notice and this permission notice shall be included  
// in all copies or substantial portions of the Software.

// THE SOFTWARE IS PROVIDED "AS IS", WITHOUT WARRANTY OF  
// ANY KIND, EXPRESS OR IMPLIED, INCLUDING BUT NOT LIMITED  
// TO THE WARRANTIES OF MERCHANTABILITY, FITNESS FOR A  
// PARTICULAR PURPOSE AND NONINFRINGEMENT. IN NO EVENT

```
// SHALL THE AUTHORS OR COPYRIGHT HOLDERS BE LIABLE FOR
// ANY CLAIM, DAMAGES OR OTHER LIABILITY, WHETHER IN AN
// ACTION OF CONTRACT, TORT OR OTHERWISE, ARISING FROM,
// OUT OF OR IN CONNECTION WITH THE SOFTWARE OR THE USE
// OR OTHER DEALINGS IN THE SOFTWARE.
```

LICENSE ISSUES

=====

The OpenSSL toolkit stays under a double license, i.e. both the conditions of the OpenSSL License and the original SSLeay license apply to the toolkit. See below for the actual license texts.

OpenSSL License

-----

```
/* =====
```

```
* Copyright (c) 1998-2018 The OpenSSL Project. All rights reserved.
```

```
*
```

```
* Redistribution and use in source and binary forms, with or without
```

```
* modification, are permitted provided that the following conditions
```

```
* are met:
```

```
*
```

```
* 1. Redistributions of source code must retain the above copyright
```

```
* notice, this list of conditions and the following disclaimer.
```

```
*
```

```
* 2. Redistributions in binary form must reproduce the above copyright
```

```
* notice, this list of conditions and the following disclaimer in
```

```
* the documentation and/or other materials provided with the
```

```
* distribution.
```

```
*
```

```
* 3. All advertising materials mentioning features or use of this
```

```
* software must display the following acknowledgment:
```

```
* "This product includes software developed by the OpenSSL Project
```

```
* for use in the OpenSSL Toolkit. (http://www.openssl.org/)"
```

```
*
```

```
* 4. The names "OpenSSL Toolkit" and "OpenSSL Project" must not be used to
```

```
* endorse or promote products derived from this software without
```

```
* prior written permission. For written permission, please contact
```

```
* openssl-core@openssl.org.
```

```

*
* 5. Products derived from this software may not be called "OpenSSL"
*   nor may "OpenSSL" appear in their names without prior written
*   permission of the OpenSSL Project.
*
* 6. Redistributions of any form whatsoever must retain the following
*   acknowledgment:
*
*   "This product includes software developed by the OpenSSL Project
*   for use in the OpenSSL Toolkit (http://www.openssl.org/)"
*
* THIS SOFTWARE IS PROVIDED BY THE OpenSSL PROJECT ``AS IS'' AND ANY
* EXPRESSED OR IMPLIED WARRANTIES, INCLUDING, BUT NOT LIMITED TO, THE
* IMPLIED WARRANTIES OF MERCHANTABILITY AND FITNESS FOR A PARTICULAR
* PURPOSE ARE DISCLAIMED.  IN NO EVENT SHALL THE OpenSSL PROJECT OR
* ITS CONTRIBUTORS BE LIABLE FOR ANY DIRECT, INDIRECT, INCIDENTAL,
* SPECIAL, EXEMPLARY, OR CONSEQUENTIAL DAMAGES (INCLUDING, BUT
* NOT LIMITED TO, PROCUREMENT OF SUBSTITUTE GOODS OR SERVICES;
* LOSS OF USE, DATA, OR PROFITS; OR BUSINESS INTERRUPTION)
* HOWEVER CAUSED AND ON ANY THEORY OF LIABILITY, WHETHER IN CONTRACT,
* STRICT LIABILITY, OR TORT (INCLUDING NEGLIGENCE OR OTHERWISE)
* ARISING IN ANY WAY OUT OF THE USE OF THIS SOFTWARE, EVEN IF ADVISED
* OF THE POSSIBILITY OF SUCH DAMAGE.
* =====
*
* This product includes cryptographic software written by Eric Young
* (eay@cryptsoft.com).  This product includes software written by Tim
* Hudson (tjh@cryptsoft.com).
*
*/

Original SSLeay License
-----

/* Copyright (C) 1995-1998 Eric Young (eay@cryptsoft.com)
* All rights reserved.
*
* This package is an SSL implementation written
* by Eric Young (eay@cryptsoft.com).
* The implementation was written so as to conform with Netscapes SSL.
*
* This library is free for commercial and non-commercial use as long as

```

```

* the following conditions are adhered to. The following conditions
* apply to all code found in this distribution, be it the RC4, RSA,
* lhash, DES, etc., code; not just the SSL code. The SSL documentation
* included with this distribution is covered by the same copyright terms
* except that the holder is Tim Hudson (tjh@cryptsoft.com).
*
* Copyright remains Eric Young's, and as such any Copyright notices in
* the code are not to be removed.
*
* If this package is used in a product, Eric Young should be given attribution
* as the author of the parts of the library used.
*
* This can be in the form of a textual message at program startup or
* in documentation (online or textual) provided with the package.
*
* Redistribution and use in source and binary forms, with or without
* modification, are permitted provided that the following conditions
* are met:
*
* 1. Redistributions of source code must retain the copyright
* notice, this list of conditions and the following disclaimer.
*
* 2. Redistributions in binary form must reproduce the above copyright
* notice, this list of conditions and the following disclaimer in the
* documentation and/or other materials provided with the distribution.
*
* 3. All advertising materials mentioning features or use of this software
* must display the following acknowledgement:
*
* "This product includes cryptographic software written by
* Eric Young (eay@cryptsoft.com)"
*
* The word 'cryptographic' can be left out if the routines from the library
* being used are not cryptographic related :-).
*
* 4. If you include any Windows specific code (or a derivative thereof) from
* the apps directory (application code) you must include an acknowledgement:
*
* "This product includes software written by Tim Hudson (tjh@cryptsoft.com)"
*
* THIS SOFTWARE IS PROVIDED BY ERIC YOUNG ``AS IS'' AND
* ANY EXPRESS OR IMPLIED WARRANTIES, INCLUDING, BUT NOT LIMITED TO, THE
* IMPLIED WARRANTIES OF MERCHANTABILITY AND FITNESS FOR A PARTICULAR PURPOSE
* ARE DISCLAIMED. IN NO EVENT SHALL THE AUTHOR OR CONTRIBUTORS BE LIABLE
* FOR ANY DIRECT, INDIRECT, INCIDENTAL, SPECIAL, EXEMPLARY, OR CONSEQUENTIAL
* DAMAGES (INCLUDING, BUT NOT LIMITED TO, PROCUREMENT OF SUBSTITUTE GOODS
* OR SERVICES; LOSS OF USE, DATA, OR PROFITS; OR BUSINESS INTERRUPTION)
* HOWEVER CAUSED AND ON ANY THEORY OF LIABILITY, WHETHER IN CONTRACT, STRICT
* LIABILITY, OR TORT (INCLUDING NEGLIGENCE OR OTHERWISE) ARISING IN ANY WAY
* OUT OF THE USE OF THIS SOFTWARE, EVEN IF ADVISED OF THE POSSIBILITY OF

```

\* SUCH DAMAGE.

\*

\* The licence and distribution terms for any publically available version or  
\* derivative of this code cannot be changed. i.e. this code cannot simply be  
\* copied and put under another distribution licence  
\* [including the GNU Public Licence.]  
\*/

The MIT License (MIT)

Copyright (c) 2016 Gabi Melman.

Permission is hereby granted, free of charge, to any person obtaining a copy  
of this software and associated documentation files (the "Software"), to deal  
in the Software without restriction, including without limitation the rights  
to use, copy, modify, merge, publish, distribute, sublicense, and/or sell  
copies of the Software, and to permit persons to whom the Software is  
furnished to do so, subject to the following conditions:

The above copyright notice and this permission notice shall be included in  
all copies or substantial portions of the Software.

THE SOFTWARE IS PROVIDED "AS IS", WITHOUT WARRANTY OF ANY KIND, EXPRESS OR  
IMPLIED, INCLUDING BUT NOT LIMITED TO THE WARRANTIES OF MERCHANTABILITY,  
FITNESS FOR A PARTICULAR PURPOSE AND NONINFRINGEMENT. IN NO EVENT SHALL THE  
AUTHORS OR COPYRIGHT HOLDERS BE LIABLE FOR ANY CLAIM, DAMAGES OR OTHER  
LIABILITY, WHETHER IN AN ACTION OF CONTRACT, TORT OR OTHERWISE, ARISING FROM,  
OUT OF OR IN CONNECTION WITH THE SOFTWARE OR THE USE OR OTHER DEALINGS IN  
THE SOFTWARE.

(C) 1995-2017 Jean-loup Gailly and Mark Adler

This software is provided 'as-is', without any express or implied  
warranty. In no event will the authors be held liable for any damages  
arising from the use of this software.

Permission is granted to anyone to use this software for any purpose,  
including commercial applications, and to alter it and redistribute it



freely, subject to the following restrictions:

1. The origin of this software must not be misrepresented; you must not claim that you wrote the original software. If you use this software in a product, an acknowledgment in the product documentation would be appreciated but is not required.
2. Altered source versions must be plainly marked as such, and must not be misrepresented as being the original software.
3. This notice may not be removed or altered from any source distribution.

Jean-loup Gailly            Mark Adler  
jloup@gzip.org            madler@alumni.caltech.edu

If you use the zlib library in a product, we would appreciate \*not\* receiving lengthy legal documents to sign. The sources are provided for free but without warranty of any kind. The library has been entirely written by Jean-loup Gailly and Mark Adler; it does not include third-party code.

If you redistribute modified sources, we would appreciate that you include in the file ChangeLog history information documenting your changes. Please read the FAQ for more information on the distribution of modified source versions.

Copyright (C) 2002 - 2018 GraphicsMagick Group

Permission is hereby granted, free of charge, to any person obtaining a copy of this software and associated documentation files (the "Software"), to deal in the Software without restriction, including without limitation the rights to use, copy, modify, merge, publish, distribute, sublicense, and/or sell copies of the Software, and to permit persons to whom the Software is furnished to do so, subject to the following conditions:

The above copyright notice and this permission notice shall be included in all copies or substantial portions of the Software.

THE SOFTWARE IS PROVIDED "AS IS", WITHOUT WARRANTY OF ANY KIND, EXPRESS OR IMPLIED, INCLUDING BUT NOT LIMITED TO THE WARRANTIES OF MERCHANTABILITY, FITNESS FOR A PARTICULAR PURPOSE AND NONINFRINGEMENT. IN NO EVENT SHALL THE AUTHORS OR COPYRIGHT HOLDERS BE LIABLE FOR ANY CLAIM, DAMAGES OR OTHER LIABILITY, WHETHER IN AN ACTION OF CONTRACT, TORT OR OTHERWISE, ARISING FROM, OUT OF OR IN CONNECTION WITH THE SOFTWARE OR THE USE OR OTHER DEALINGS IN THE SOFTWARE.



# Cut2D Desktop User Guide

# Introduction

This manual is designed to provide a comprehensive description of all the functions, tools, menus and icons available within the Cut2D Desktop software package.

Access this document from Cut2D Desktop's **Help Menu ► Help Contents** or from the Cut2D Desktop folder in the program section of your Windows Start menu.

At the bottom of the page you will see an area with **View All Help**. This will download all the Help Documentation as a single web page which is useful for searching or if you need to create a paper copy of the documentation.

## User Guides, tutorial and training

Please note that this document is a Reference Manual. If you require more guidance, or are still learning how to use Cut2D Desktop, please ensure that you view the Getting Started Video Tutorials in the Cut2D Desktop Video Tutorial Browser when starting the software.

Cut2D Desktop also includes an extensive selection of video tutorials, which are accessible from the Tutorial Video Browser link when application first starts. These tutorials cover every aspect of Cut2D Desktop's functionality and range in complexity from a beginner's overview, to advanced features and principles. They are intended to be extremely accessible by level of experience or topic and use real-world examples throughout. Videos can be watched online, or installed locally.

We welcome any comments on this manual or the other training material, please email [support@vectric.com](mailto:support@vectric.com) with your feedback.

# General Workflow

Cut2D Desktop has been developed to allow the production of decorative and artistic dimensional carved parts. As well as drawing and modeling tools, it includes both 2D and 3D machining, along with 3D V-Carving / 3D Engraving to allow a huge variety of jobs to be produced as quickly and easily as possible. The general work flow logic to apply to most jobs is explained in the diagram below:

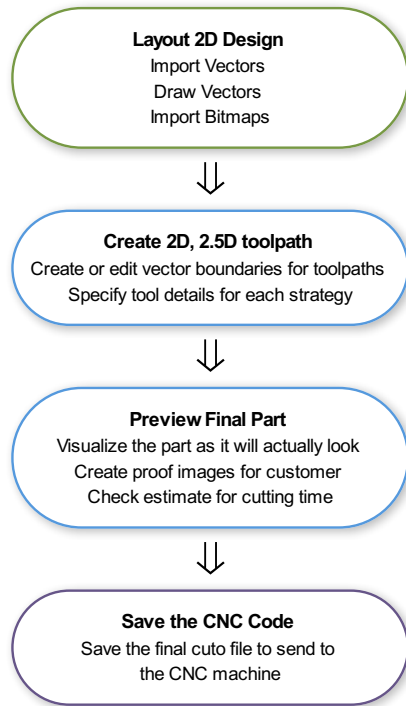

## Design

Cut2D Desktop includes drawing and editing tools that allow designs to be created and modified. Functions for vector creation and editing are very easy to use and multiple design elements can also be drawn or imported, scaled, positioned and interactively edited to make a new design. Text can also be created using any TrueType or OpenType fonts installed on your computer, or the single stroke engraving fonts supplied with the software.

## Toolpath

A comprehensive set of 2D, V-Carving, Engraving and 3D toolpath strategies provide you with efficient ways to use your tooling to carve the finished part. This process is usually relatively independent of drawing or modeling (although toolpaths are often created directly from some artwork or 3D composite models). Cut2D Desktop provides simple interface buttons to toggle screen layout to assist the shift in focus from design to toolpathing.

## Output

Finally you can use Cut2D Desktop's large selection of post-processors to save toolpaths in precisely the format that your particular CNC machine tool requires.

# Overview of the Interface

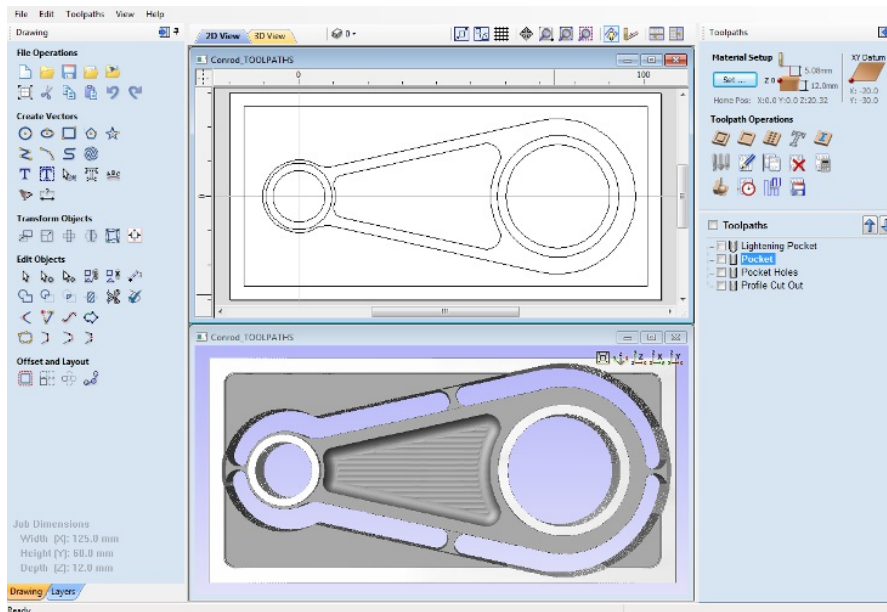

1. The Main Menu Bar (the Drop Down Menus) along the top of the screen (File, Edit, Model, Toolpaths, View, Gadgets, Help) provides access to most of the commands available in the software, grouped by function. Click on any of the choices to show a Drop-Down list of the available commands.
2. The Design Panel is on the left side of the screen. This is where the Drawing and Layers tab can be accessed and the icons within the tabs to create a design.
3. The Toolpath Tab is on the right side of the screen. The Top section of the toolpaths tab houses all of the icons to create, edit and preview toolpaths. The bottom half shows you toolpaths that you have already created.
4. The 2D Design window is where the design is drawn, edited and selected ready for machining. Designs can be imported or created directly in Cut2D Desktop. This occupies the same area as the 3D View and the display can be toggled between the two using F2 and F3 or the tabs at the top of the window.
5. The 3D View is where the toolpaths and the toolpath preview are displayed.
6. If you wish to see the 2D and 3D views simultaneously, or you wish to switch your focus to the Toolpaths tab at a later stage of your design process, you can use the interface layout buttons (accessible in the 2D View Control section on the Drawing Tab) to toggle between the different preset interface layouts.

## Managing the Interface

The Drawing, Layers and Toolpath tool pages have Auto-Hide / Show behavior which allows them to automatically close when not being used, thus maximizing your working screen area.

Cut2D Desktop includes two default layouts, one for designing and one for machining, which can automatically and conveniently set the appropriate auto-hide behavior for each of the tools pages. Toggle layout buttons on each of the tools pages allow you to switch the interface as your focus naturally shifts from the design stage to the toolpathing stage of your project.

## Accessing Auto-hidden tabs

If a tools page is auto-hidden (because it is currently unpinned, see pinning and unpinning tools pages, below), then it will only appear as a tab at the side of your screen. Move your mouse over these tabs to show the page temporarily. Once you have selected a tool from the page, it will automatically hide itself again.

**Note:** If you find that you are using the tools on an auto-hidden tab frequently, you may wish to use Cut2D Desktop's preset layout buttons to toggle the interface to a more appropriate default. Alternatively you can pin the hidden tab out to prevent it from auto-hiding (see below).

## Pinning and unpinning tools pages

The auto-hide behavior of each tools page can be controlled using the push-pin icons at the top right of the title area of each page.

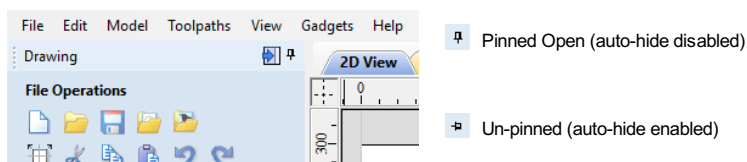

## Default layout for Design and Toolpaths

Cut2D Desktop has two default tool page layouts that are designed to assist the usual workflow of design, followed by toolpath creation.

In both the Drawing and Toolpaths Tabs there are 'Switch Layout' buttons, these buttons will shift the interface's focus to toolpath tasks by 'pinning-out' the Toolpaths tools tab, and 'unpinning' the Drawing tab. In the toolpaths tab, the button reverses the layout - unpinning the toolpaths Tab, and pinning-out the Drawing Tab.

You can toggle between these two modes using the `F11` and `F12` shortcut keys.

# How to Get Started

The first stage in any project is to create a new blank part or import some existing data to work with. At this stage a number of parameters need to be defined relating to the size of the part and its position relative to the datum location on the CNC machine. Later, once the part has been defined and you have started working, you may want to change the size of the material, import additional data and generally manage the project operation. In this section of the manual the initial creation of a part will be covered along with all the icons which appear under the File Operations section of the Drawing Tab.

When you first start the program you will see the Startup Task options on the left hand tab and also a list of your 4 most recently opened Cut2D Desktop parts (this is a rolling list that will be populated each time you run the software and may initially be empty).

## Startup Tasks and Recently Opened Files

When you first start the program you will see the Startup Task options on the left hand tab and also a list of your most recently opened Cut2D Desktop parts.

The first choice is whether you want to *Create a new file* or *Open an existing one*.

The first choice is whether you want to *Create a new file* or *Open an existing one*. Creating a new file allows you specify a size and location for a blank work area, set your material thickness and also set the model quality and even the shading color/material. The process to do this will be covered in the next section (Job Setup Form Options).

The second choice, *Open an Existing File*, will allow you to open a pre-created file from your computer. This may be a file you previously created in Aspire (\*.crv3d), or a VCarve Pro job (\*.crv). Alternatively, it might be a 2D vector layout from another CAD system (\*.dxf, \*.eps, \*.ai and \*.pdf). A CRV3D or CRV file will have the necessary information for material size etc. already embedded in it. The 2D formats will import the data at the size and position it was created but will require you to go through the Job Setup form to verify/edit all the parameters for the part.

## Video Tutorials

The Tutorial Video Browser will open your default web browser (typically Internet Explorer, Chrome or Firefox - depending on your Windows setup and personal preference). The web browser offers a number of tutorial videos and associated files, presented either by project or feature category to help you to learn about the software. You will initially need internet access to watch or download the videos or files, but, once downloaded, the materials can be used offline.

## Online Resources

This section includes direct links to useful websites and web resources - including clipart and projects for you to purchase, download and incorporate into your own designs. These links will also open in your default web browser and you will need internet access to use them.

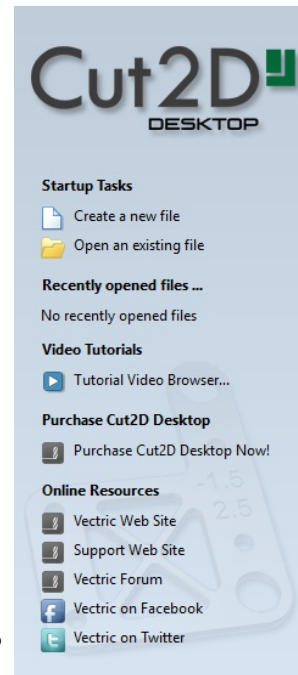



# Frequently Asked Questions

## Navigating this Document

Click ► **Arrow Triangles** to open a fold in the document.

Open all folds before printing or searching for text in this document.

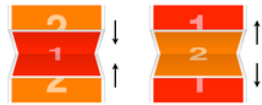

[Close All Folds] [Open All Folds]

## General Questions

- Where can I get **Help**?
- What **file formats** can be used?
- What are the limitations of the **Trial Versions**
- What are the **minimum requirements** for my PC to run Vectric software?
- How many **computers** can I install my Vectric software on?
- Do you have **educational pricing** for Vectric Software?
- Can I run the **Trial Version** in a **non-English** version?
- Why do I receive an **error opening recent files**?
- Why do I get "An unknown error occurred while accessing an unnamed file" when saving to a network location?
- Where is the **Vectric Files** folder?
- Where do I look to find the **Tool Database** on my PC?
- Where do I look to find the **Post Processors** folder on my PC?
- Where do I look to find the **Gadgets** folder on my PC?
- What is the **latest software version** available?
- What is the difference between **Updates** and **Upgrades**?
- What are **Gadgets**?
- What is the **Vectric License Transfer Policy**?
- I **Need to Email Support**
- How do I use **tutorials** in the **Trial Edition**?
- How do I **Uninstall Vectric Software**?
- How do I **find which version** of the software I am running?
- How do I **find and install an update** when a newer version of the software is available?
- How do I **download my free Clipart**?
- How do I **add new material image files** to the available list?
- How do I **access installed Video Tutorials**?
- How can I **compare** the features of each Program?
- **Dropbox and File Sharing Folders**
- **Double Clicking loads older version**
- Can Vectric software run the **CarveWright** machine?
- Can I open the files created in the **Trial Version** of the software into the full version?

## 2D Design - Vectors & Images

- Can I open **Corel Draw** files?
- How can I change the **Job / Material Size**?
- Will the Vectric programs allow **mathematical equations** to be calculated?
- Why **group vectors**?
- When moving a vector using the **Move Selected Objects** tool, what is the difference between **Absolute** and **Relative** modes?
- What do the different **line colors** mean?
- What is the difference between **Ungroup** back to original objects layer and **Ungroup** onto groups layer?
- What is an **open** or **closed** vector?
- What is a **node** and how do I use them?
- What **fonts** come with the program?
- What are the **Special Calculation Characters**?
- What are the **Node Editing** Short-cut Keys?
- What are the **Keyboard Short cut Keys**?
- What are some problems and solutions for **importing DXF** files?
- **Special Characters - Draw Text**
- How do you determine which side of an open vector is the **right** or **left**?
- How do I display all the **Alignment icons** on the **Drawing Tab**?
- How can I work with a drawing that has both **metric and imperial** measurements?
- How can I import the **image** if my **PDF** does not contain vector information?

- ▶ How can I close an open vector?
- ▶ How can I change the **Start Point** of a vector?
- ▶ How can I change **text spacing** (kerning)?
- ▶ How can I add **more fonts**?
- ▶ Do I need to use **layers**?
- ▶ Can Vectric software run **plasma/water jet** machine tools?
- ▶ Can I work with an **image file** (bmp, tiff, jpeg etc.)?
- ▶ Can I use a **Snap Grid** or **Guide Lines** to help me work with vectors?
- ▶ Are there any **shortcuts** for controlling the view in the 2D Design window?

## SketchUp

- ▶ What is SketchUp?
- ▶ Why is my imported model much **too big** or much **too small**?
- ▶ When I **import** my model, I get **multiple copies** of components.
- ▶ When I import a flat panel with a **rounded edge** as a vector import it does not record the rounded edge.
- ▶ What version of Aspire or VCarve should I use to open SketchUp files?
- ▶ What sort of designs should I be using SketchUp for with Aspire and VCarve?
- ▶ What should I **save my Sketchup** model to import Vectors to Aspire or VCarve?
- ▶ What does **Auto Orientate** do in the Vector Import dialogue for SketchUp?
- ▶ My model does not look as smooth as it did in my other 3D package.
- ▶ My 3D SketchUp model is not importing to **flat panels** correctly in Aspire or VCarve
- ▶ I have **updated Sketchup** and now cannot open my files in Aspire or VCarve
- ▶ Why I can **see through** my model when it is imported?
- ▶ How do I **import SketchUp** models?
- ▶ How can I import a **2-sided SketchUp** model?
- ▶ How can I get the **best results** with the SketchUp Vector import?
- ▶ Can I import **SketchUp models** into Aspire/VCarve?

## Toolpaths

- ▶ How can I **open a file** from Cut3D (V3D), Vector Art 3D Machinist (V3M) or PhotoVCarve (PVC) in Aspire, VCarve or Cut2D?
- ▶ How can I tell **how deep** my V-Carving is?
- ▶ Will my CNC do **V-carving** work?
- ▶ Why is the **machined edge of my dish** model rough or have a ridge around it?
- ▶ Why is **no toolpath** being calculated for the vectors I have selected?
- ▶ Why does my actual cut part not look like the **Preview Image**?
- ▶ When should I use a **Start Depth**?
- ▶ What is the difference between changing a **tool's settings** in the Tool Database and Editing a tool in the Toolpath setup?
- ▶ What is the **"Solid"** option?
- ▶ What do I need to reset after a **tool change**?
- ▶ What controls the depth where the **tabs** are in a toolpath?
- ▶ **Saving Images** with a plain background?
- ▶ In the Profile Toolpath, what is **Allowance Offset** used for?
- ▶ In the Pocket Toolpath, what is **Pocket Allowance** used for?
- ▶ How do **Start Depth** and **Cut Depth** work together?
- ▶ How do I use the two **Safe Z** settings, Z1 and Z2?
- ▶ How do I **transfer the toolpaths** to the machine tool?
- ▶ How do I setup the **start point** of the toolpath?
- ▶ How do I set the **Cut Depth** when V-carving?
- ▶ How do I machine a **single line font**?
- ▶ How do I ensure my bit will not hit a clamp when traveling across the machine bed?
- ▶ How can I remember what **Allowance Offset** or **Pocket Allowance** will change in my toolpath?
- ▶ How can I make **copies of a toolpath** to cut multiple versions of the same part?
- ▶ How can I machine a project which is larger than my CNC work area?
- ▶ How can I improve the **edge quality** of my 3D model when machining it?
- ▶ How can I **improve the cut quality** when working with difficult materials and/or deep V-carvings?
- ▶ How can I get an **estimate** of how long the toolpath will take to actually cut?
- ▶ How can I find the correct **post processor** for my machine tool?
- ▶ How can I create a new **custom tool**?
- ▶ How can I control **how many passes** (depths of cut) my toolpath will take?
- ▶ How can I adjust the **depth** of my V-carving when it is too deep or too shallow?
- ▶ Does Vectric software support **Tool Changers**?
- ▶ Can I create a tool with an **undercut**?
- ▶ Can I control the speed of the **Toolpath Preview**?
- ▶ Can I add different types of **preview materials**?
- ▶ Are there any **shortcuts** for controlling the view in the 3D Preview window?

# 2D Design and Management

The 2D View is used to design and manage the layout of your finished part. Different entities are used to allow the user to control items that are either strictly 2D or are 2D representations of objects in the 3D View. A list of these 2D View entities are described briefly below and more fully in later sections of this manual.

Ultimately the point of all these different types of objects is to allow you to create the toolpaths you need to cut the part you want on your CNC. This may mean that they help you to create the basis for the 3D model or that they are more directly related to the toolpath such as describing its boundary shape. The different applications and uses for these 2D items mean that organization of them is very important. For this reason Cut2D Desktop has a Layer function for managing 2D data. The Layers are a way of associating different 2D entities together to allow the user to manage them more effectively. Layers will be described in detail later in the relevant section of this manual. If you are working with a 2 Sided project you can switch between the 'Top' and 'Bottom' sides in the same session, enabling you to create and edit data on each side, and using the 'Multi Sided View' option you can view the vectors on the opposite side. 2 Sided Setup will be described in detail later in the relevant section of this manual.

## Vectors

Vectors are lines, arcs and curves which can be as simple as a straight line or can make up complex 2D designs. They have many uses in Cut2D Desktop, such as describing a shape for a toolpath to follow or being a controlling 2D shape for use with one of the 3D modeling functions such as the 2 Rail Sweep. Cut2D Desktop contains a number of vector creation and editing tools which are covered in this manual.

As well as creating vectors within the software many users will also import vectors from other design software such as Corel Draw or AutoCAD. Cut2D Desktop supports the following vector formats for import: \*.dxf, \*.eps, \*.ai, \*.pdf, \*.skp and \*.svg. Once imported, the data can be edited and combined using the Vector Editing tools within the software.

## Bitmaps

Although bitmap is a standard computer term for a pixel based image (such as a photo) in \*.bmp, \*.jpg, \*.gif, \*.tif, \*.png and \*.jpeg. These file types are images made up of tiny squares (pixels) which represent a scanned picture, digital photo or perhaps an image taken from the internet.

To make 3D models simple to create, Cut2D Desktop uses a method which lets the user break the design down into manageable pieces called Components. In the 2D View a Component is shown as a Grayscale shape, this can be selected and edited to move its position, change its size etc. Working with the Grayscale's will be covered in detail later in this manual. As with bitmaps, many of the vector editing tools will also work on a selected Component Grayscale.

## Vectors

Vectors have two very important uses:

1. To describe the shape/boundary/direction of a toolpath
2. To control 3D shapes created using the icons under the Modeling Tools

As they are such an important part of two of the fundamental areas of the software there are a lot of tools to create, edit and manage them. In this section all these tools and vectors options will be briefly described. For practical examples of these tools you should review the tutorial videos.

## Vector Import

Decorative vector designs and shapes will often be imported from another drawing package such as Corel Draw, AutoCAD etc. rather than being completely drawn in Cut2D Desktop. The Vector Import icon  is located in the File Operations area of the Drawing Tab. Once a vector has been imported then the imported vector shape(s) can be modified, moved, scaled, rotated, mirrored or deleted the same as vectors created within the software.

The following Vector file formats can imported

SVG	SVG files are two dimensional vector graphics which can be created within Vectric software but also from other CAD packages such as Inkscape or Adobe Illustrator. If you open this file type from <b>File ► Open</b> , this will automatically import the vectors and open up the Job Setup Form. If opened from the <b>File ► Import ► Import Vectors</b> , this will import the vectors directly into the current job.
DXF and DWG	Files from other CAD or graphics software packages such as AutoCAD will be opened in the original size and position. The Job Setup Form is automatically opened showing the maximum X and Y dimensions of the opened design. The actual size of the material can then be specified along with the required thickness and appropriate X0, Y0 and Z0 origins.
EPS	Files from typical design software such as Corel Draw can be opened. The Job Setup form will automatically be opened so the required material size can be specified. By default the EPS file will be placed with the lower left corner of the design at X0, Y0.
AI	Files from typical design software such as Adobe Illustrator and Corel Draw can be opened. The Job Setup form will automatically be opened so the required material size can be specified. The AI file will be placed with the lower left corner of the design at X0, Y0
PDF	Software such as the Adobe product range can be used to convert files from other design and word processing software into the industry standard PDF file format. The text and vector content of PDF files is extracted when imported into Cut2D Desktop. When importing multiple page PDF documents each page is placed on a separate layer.

While every endeavor is made to keep up with other software companies' changes in their file format it is possible that files in the above formats may not always be readable in Cut2D Desktop. In that case going back to the original design systems and saving the file in an earlier version may enable it to be loaded into Cut2D Desktop. In addition Cut2D Desktop may not support the import of special entities such as dimensions, hatching, text, numbers etc. from some vector file types. It may be possible to adjust the formatting for these objects in their original design program. This is often done using a command called **Convert to Curves**. This will change this type of data to regular vectors that can then be exported in a compatible format for import.

## Two-Sided Machining

Cut2D Desktop has the ability to create a project where your design requires you to cut *both sides* of your material. Typically you will cut the top surface of your material, then manually turn the material block over on your machine, whilst maintaining a common registration position, and cut the bottom surface using a second set of toolpaths. By specifying a two-sided project using the Job Setup form and indicating how you intend to flip the material over on your machine, you can allow the registration and organisation of the geometry, toolpaths and previews relating to each side of the design to be managed by the software. During the design process you can then switch between the top and bottom surface of your design, create toolpaths for each side and view a preview of the material - including after it has been cut from both directions. Once you are happy with the result you can then save the toolpaths relating to each side independently.

### Two-Sided Job Setup

In the Job Setup dialog, you can pick whether you want to create a single-sided or a double-sided job. You can change this setting later if you wish.

The initial **Z-Zero Position** you will be using for the toolpaths relating to each side is set from the *Job Setup* dialog. You can choose to Z-Zero from the same material surface for both sides, the machine bed for both sides or you can opt to Z-Zero from each side independently. Your choice depends on the nature of your design. Typically, if you are only intending to carve into the surface on each side then you will Z-Zero each independently after you have physically positioned the material on your machine. If your design involves cutting through the material and the Z depths for each side must coincide precisely, however, then you will usually wish to use a common Z position for both sides. You can change the Z-Zero settings for each side subsequently using the *Material Setup* form.

**Note:** In the **Z Zero Position** form diagram, the relative Z Zero position (shown with a red dot) indicates relative position to the Top Side (1) and the Bottom Side (2) when the material block has been turned to machine each side with the currently selected Z Zero Position settings.

The **XY Datum Position** applies to both sides of the material.

In order to correctly manage the alignment of the geometry relating to each side, it is important that the software knows whether material will be flipped vertically or horizontally during the physical machining process. **Flip Direction Between Sides** determines the automatic transformation of the drawings, models or toolpaths associated with each side. If the material block will be flipped horizontally then the software will automatically mirror your data to mimick the relative positions each side.

When you create or open a two-sided project, Cut2D Desktop will display two new icons in the 2D View Toolbar. The first icon indicates which flip direction option has been specified for this project. It will initially be set to display the Top Side of

your design. Any drawing or toolpath creation will be associated with the Top Side and this is known as the active side. To work on the other side of your design you will first need to make the Bottom Side active. Click on the Toggle Side button in the View Toolbar to switch the active side between top and bottom. Alternatively, you can use the number key shortcuts: **1** will make Top Side active and pressing **2** will make the Bottom Side active.

**Note:** The rulers that border the 2D View are colored to provide a handy visual indicator as to which side is currently active. An **Orange** background indicates that the Bottom side is currently active and any drawing or toolpaths are associated with the Bottom Side of your design.

## Two-Sided Toolpath Management

When toolpaths are created in a two-sided job they are automatically associated with the active side from which they were created. This helps you to keep track of which side of your job each toolpath is for. The toolpath list will only display the toolpaths for the current active side and this is indicated in the heading, which will read **Toolpaths (Top)** or **Toolpaths (Bottom)** accordingly. Changing the active side (using **1** or **2**, for example) will cause the toolpaths list to also swap the displayed set of toolpaths.

## Two-Sided Toolpath Previewing

The Preview Toolpaths form now includes a **Preview All Sides** button. This will simulate toolpaths cutting both sides of your job (regardless of the currently active side) so that you can see the combined result of your toolpaths in a single, solid, 3D representation of the final job.

## Two-Sided Toolpath Saving

Saving your toolpaths from a two-sided job is done independently for each side. Save the toolpaths for the currently active side, then make the other side active (using **1** or **2**) and save out the toolpaths for the other side.

**Note:** To continue to help you to organise your toolpaths once you get to your CNC Machine, you can check the **Add side to toolpath name** option before saving your toolpaths to explicitly add the side to the saved filename for each toolpath.

## 2D View

Shows the workspace defined when you create a new file. This is used to control the XY layout of vectors and bitmaps. Typically you select an item from this view by clicking on it or dragging a box around it with the mouse. To move it you can click a selected item a second time to go into Transform mode. Some items when double clicked will open a form relating to the object and many have functions related to them displayed when you right mouse click over them.

## 3D View

This shows any visible Toolpaths when using the preview toolpath option.

## Bitmap

Generic term used to describe any raster (pixel) based image which can be imported into Cut2D Desktop using the Import Bitmap For Tracing icon. File types supported are: .bmp, .jpg, .gif, .tiff, .png and .jpeg. Bitmaps are primarily used for tracing vectors over to create toolpaths.

## Group

When you want to manipulate a number of objects together you can Group them. This is a temporary operation to ease the selection, movement, scaling, and rotation etc. of several objects at once. It is reversed by Ungrouping.

## Ungroup

Separates a set of Grouped Objects so that they can be manipulated independently again.

## File

Generic name most often used to describe a complete Cut2D Desktop project (CRV file) which contains all the 2D and Toolpath information in a single saved file - also sometimes referred to as a Part.

## Short Cut Keys

Keys on the keyboard which will activate certain commands when pushed. Example `F4` to activate the Snapping Options Dialog. You can find a full list of all the Shortcut Keys in the online reference manual in the Frequently Asked Questions section.

## Vector

A 2D object represented by lines, arcs or curves.



*Version 9*

---

Copyright © 2019 Vectric Ltd.